

# A New Perspective on Magnetic Field Sensing

**Michael J. Caruso**  
**Tamara Bratland**  
Honeywell, SSEC  
12001 State Highway 55  
Plymouth, MN 55441  
<www.ssec.honeywell.com>

**Dr. Carl H. Smith**  
**Robert Schneider**  
Nonvolatile Electronics, Inc.  
11409 Valley View Road  
Eden Prairie, MN 55344  
<www.nve.com>

## ABSTRACT

The earliest magnetic field detectors allowed navigation over trackless oceans by sensing the Earth's magnetic poles. Magnetic field sensing has vastly expanded as industry has adapted a variety of magnetic sensors to detect the presence, strength, or direction of magnetic fields not only from the Earth, but also from permanent magnets, magnetized soft magnets, vehicle disturbances, brain wave activity, and fields generated from electric currents. Magnetic sensors can measure these properties without physical contact and have become the eyes of many industrial and navigation control systems. This paper will describe the current state of several methods of magnetic sensing and how the sensors are used—many with integrated functions. Finally, several applications will be presented for magnetic sensing in systems.

## INTRODUCTION

Magnetic sensors have been in use for well over 2,000 years. Early applications were for direction finding, or navigation. Today, magnetic sensors are still a primary means of navigation but many more uses have evolved. The technology for sensing magnetic fields has also evolved driven by the need for improved sensitivity, smaller size, and compatibility with electronic systems. This paper will overview various types of magnetic sensors and their applications. It is not intended as a how-to description of building sensor systems but more of a what is this sensor and how does it detect magnetic fields. The newest types of silicon based magnetic sensors will be emphasized—anisotropic magnetoresistive (AMR) and giant magnetoresistive (GMR) sensors. Applications for AMR and GMR magnetic sensors are presented.

A unique aspect of using magnetic sensors is that measuring magnetic fields is usually not the primary intent. Another parameter is usually desired such as wheel speed, presence of a magnetic ink, vehicle detection, or heading determination. These parameters cannot be measured directly, but can be extracted from

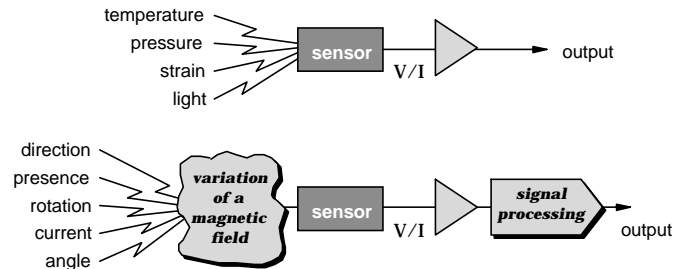
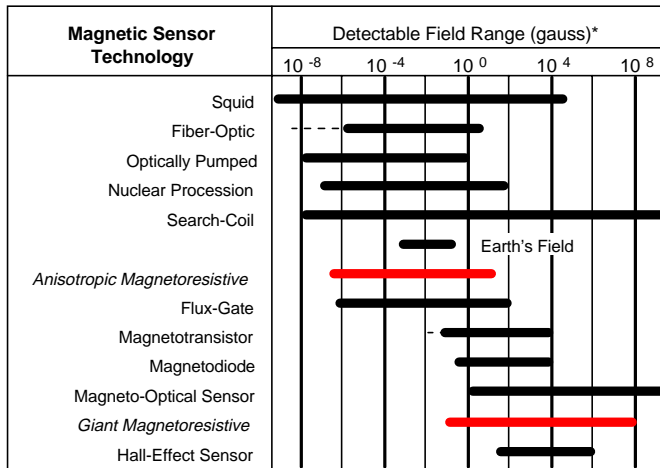

Figure 1. Conventional vs. Magnetic Sensing

changes, or disturbances, in magnetic fields. Figure 1 shows other sensors, such as temperature, pressure, strain, or light that can be detected using an appropriate sensor. The output of these sensors will directly report the desired parameter. On the other hand, using magnetic sensors to detect direction, presence, rotation, angle, or electrical currents only indirectly detect these parameters. First, the enacting input has to create, or modify, a magnetic field. A current in a wire, a permanent magnet, or sensing the Earth's magnetic field can create this field. Once the sensor detects that field, or change to a field, the output signal requires some signal processing to translate the sensor output into the desired parameter value. This makes magnetic sensing a little more difficult to apply in most applications, but it also allows for reliable and accurate sensing of parameters that are difficult to sense otherwise.

One way to classify the various magnetic sensors is by the field sensing range. These sensors can be arbitrarily divided into three categories—low field, medium field, and high field sensing. Sensors that detect magnetic fields less than 1 microgauss will be classed low field sensors. Sensors with a range of 1 microgauss to 10 gauss will be considered Earth's field sensors and sensors that detect fields above 10 gauss will be considered bias magnet field sensors for this paper. Table 1 lists the various sensor technologies and illustrates the magnetic field sensing ranges [1].



\* Note: 1gauss = 10<sup>-4</sup>Tesla = 10<sup>5</sup>gamma

Table 1. Magnetic Sensor Technology Field Ranges

In the following sections, several types of magnetic field sensors are described—both the physical principles which cause them to work and the embodiment of these principles into sensors. The magnetic field is a vector quantity that has both magnitude and direction. Magnet sensors measure this quantity in various ways. Some magnetometers measure total magnitude but not direction of the field (scalar sensors). Others measure the magnitude of the component of magnetization which is along their sensitive axis (omni-directional sensors). This measurement may also include direction (bi-directional sensors). Vector magnetic sensors have 2 or 3 bi-directional sensors. Some magnetic sensors have a built in threshold and produce an output only when that threshold is passed. The types of magnetic sensors which will be described will include older techniques including Reed Switches, Variable Reluctance Sensors, Flux-gate Magnetometers, Magneto-Inductor Sensors, and Hall Devices as well as the relatively new solid state sensors including Anisotropic Magneto-resistive (AMR) Sensors and Giant Magnetostrictive (GMR) Sensors.

**LOW FIELD SENSORS** (*less than 1 microgauss*)

The low field sensors are used for medical applications and military surveillance. They generally tend to be bulky and costly compared to other magnetic field sensors. Care must be taken to account for the effects of the Earth's field since daily variations in the Earth's field may exceed the measurement range of a low field sensor.

**SQUID**

The most sensitive low field sensor is the Superconducting QUantum Interference Device (SQUID). Developed around 1962 with the help of Brian J. Josephson's work that developed the point-contact junction to measure extremely low current [1]. The SQUID magnetometer has the capability to sense field in the range of several fempto-tesla (fT) up to 9 tesla. That is a range of over 15 orders of magnitude! This is key for medical use since the neuromagnetic field of the human brain is only a few tenths of a fempto-tesla [2]. That is 10<sup>-8</sup> times weaker than the Earth's magnetic field. The present designs require cooling to liquid helium temperature (4 K) but higher temperature techniques are being developed. SQUID devices, like the HS07, are available from F.I.T. in Germany and research is being done at Shimadzu Corporation in Japan. SQUID magnetometers can be found at many research institutes and universities that are used for the characterization of magnetic materials.

**Search-Coil**

Another common low field sensor is the basic search-coil magnetometer based on Faraday's law of induction—which states that the voltage induced in a coil is proportional to the changing magnetic field in the coil. This induced voltage creates a current that is proportional to the rate of change of the field. The sensitivity of the search-coil is dependent on the permeability of the core, and the area and number of turns of the coil. In order for the search-coil to work, the coil must either be in a varying magnetic field or moving through a magnetic field. This restricts the search-coil from detecting static, or slowly changing, fields. These sensors are commonly found in the road at traffic control signals. They are low cost and easily manufactured.

**Other Low Field Sensors**

Other low field sensor technologies include nuclear precession, optically pumped, and fiber-optic magnetometers. These are precision level instruments used for laboratory research and medical applications. For instance, the long-term stability of the nuclear precession magnetometer can be as low as 50pT/year. These magnetometers will not be discussed in this paper.

**EARTH'S FIELD SENSORS** (*1 microgauss to 10 gauss*)

The magnetic range for the medium field sensors lends itself well to using the Earth's magnetic field. Several ways to use the Earth's field are to determine compass headings for navigation, detect anomalies in it for vehicle detection, and measure the derivative of the change in field to determine yaw rate.

## Fluxgate

Fluxgate magnetometers are the most widely used sensor for compass navigation systems. They were developed around 1928 and later refined by the military for detecting submarines. Fluxgate sensors have also been used for geophysical prospecting and airborne magnetic field mapping. The most common type of fluxgate magnetometer is called the second harmonic device [3-5]. This device involves two coils, a primary and a secondary, wrapped around a common high-permeability ferromagnetic core. The magnetic induction of this core changes in the presence of an external magnetic field. A drive signal is applied to the primary winding at frequency  $f$  (e.g. 10 kHz) that causes the core to oscillate between saturation points. The secondary winding outputs a signal that is coupled through the core from the primary winding—see Figure 2. This signal is affected by any change in the core permeability (slope of B-H curve) and appears as an amplitude variation in the sense coil output. By using a phase sensitive detector, the sense signal can be demodulated and low pass filtered to retrieve the magnetic field value. Another way of looking at the fluxgate operating principle is to sense the ease, or resistance, of saturating the core caused by the change in its magnetic flux. The difference is due to the external magnetic field.

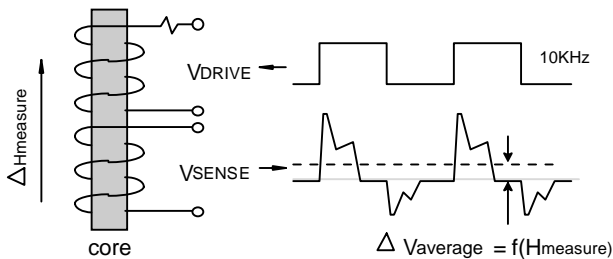

Figure 2. Fluxgate Magnetometer Operation

Fluxgate magnetometers can sense signal in the tens of microgauss range with careful design consideration. Fluxgates can measure both magnitude and direction of static magnetic fields and have an upper frequency band limit of around 1 kHz—due to the drive frequency limit of around 10 kHz. They also tend to be bulky and not as rugged as smaller, more integrated, sensor technologies. Fluxgates are available from Applied Physics Systems (APS520), Zemco, Inc. (DE-710), Bartington Instruments (Mag-03), Walker Scientific Inc. (WS-43), and Haltek Electronics (Sunnyvale, CA).

## Magnetoinductive

Magnetoinductive magnetometers are relatively new with the first patent issued in 1989. The sensor is simply a single winding coil on a ferromagnetic core that changes permeability within the Earth's field. The sense coil is the inductance element in a L/R relaxation oscillator. The frequency of the oscillator is proportional to the field being measured. A static dc current is used to bias the coil in a linear region of operation (see Figure 3). The observed frequency shift can be as much as 100% as the sensor is rotated 90 degrees from the applied magnetic field. The oscillator frequency can be monitored by a microprocessor's capture/compare port to determine field values. These magnetometers are simple in design, low cost, and low power. They are available from Precision Navigation, Inc. and used in compass applications. They have a limited temperature range of -20 to 70 degree C, and are repeatable to within 4 milligauss. The small size and shape makes it difficult to for automatic assembly and axis alignment.

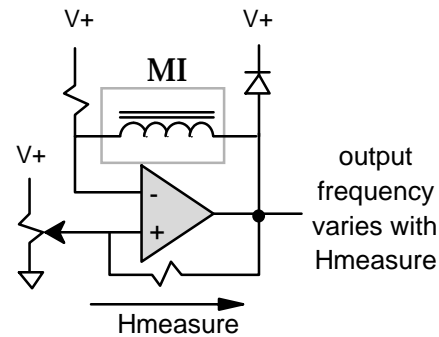

Figure 3. Magnetoinductive (MI) Sensor Circuit

## Anisotropic Magneto resistive (AMR)

William Thompson, later Lord Kelvin [6], first observed the magnetoresistive effect in ferromagnetic metals in 1856. This discovery had to wait over 100 years before thin film technology could make a practical sensor for application use. Magnetoresistive (MR) sensors come in a variety of shapes and form. The newest market growth for MR sensors is high density read heads for tape and disk drives. Other common applications include automotive wheel speed and crankshaft sensing, compass navigation, vehicle detection, current sensing, and many others.

The anisotropic magnetoresistive (AMR) sensor is one type that lends itself well to the Earth's field sensing range. AMR sensors can sense dc static fields as well as the strength and direction of the field. This sensor is made of a nickel-iron (Permalloy) thin film deposited on a silicon wafer and is patterned as a resistive strip. The properties of the AMR thin film cause it to change resistance by 2-3% in the presence of a magnetic field. Typically, four of these resistors are connected in a Wheatstone bridge configuration (see Figure 4) so that both magnitude and direction of a field along a single axis can be measured. For typical AMR sensors, the bandwidth is in the 1-5 MHz range. The reaction of the magnetoresistive effect is very fast and not limited by coils or oscillating frequencies. The key benefit of AMR sensors is that they can be bulk manufactured on silicon wafers and mounted in commercial integrated circuit packages. This allows magnetic sensors to be auto-assembled with other circuit and systems components. AMR sensors are available from Philips, HL Planar, and Honeywell.

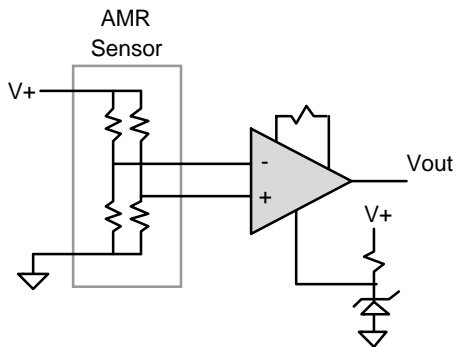

Figure 4. AMR Sensor Circuit

#### AMR Sensor Characteristics

AMR sensors provide an excellent means of measuring both linear and angular position and displacement in the Earth's magnetic field. Permalloy thin films deposited on a silicon substrate in various resistor bridge configurations provide highly predictable outputs when subjected to magnetic fields [6-8]. Low cost, high sensitivity, small size, noise immunity, and reliability are advantages over mechanical or other electrical alternatives. Highly adaptable and easy to assemble, these sensors solve a variety of problems in custom applications.

Most AMR sensors are made of Permalloy (NiFe) thin film deposited onto a silicon substrate and patterned to form a Wheatstone resistor bridge. A common bridge resistance is 1 kohm.

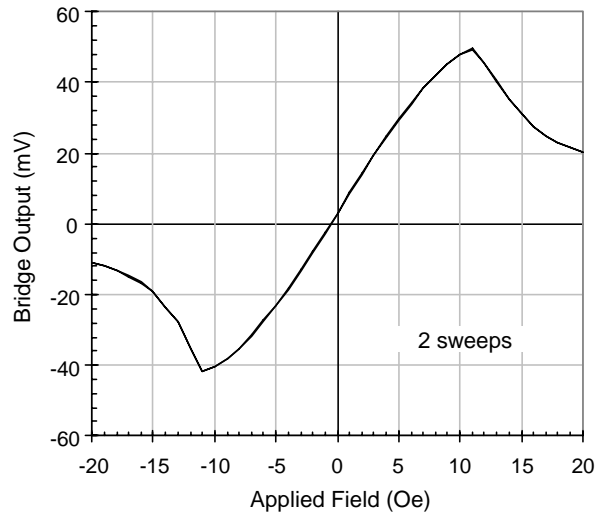

Figure 5. AMR Output Transfer Curve

The AMR film properties are well behaved only when the film's magnetic domains are aligned in the same direction. This assures high sensitivity and good repeatability with minimal hysteresis. During fabrication, the film is deposited in a strong magnetic field. This field sets the preferred orientation, or easy axis, of the magnetization vector ( $M$ ) in the Permalloy resistors (see Figure 6). The  $M$  vector is set parallel to the length of the resistor and can be set to point in either direction, left or right, in the film. Assume for a moment that there is a current in the film flowing at a 45-degree angle to the length of the film. This creates an angle  $\theta$  between the current flow and  $M$  vector. The electrical properties of the Permalloy film has a relationship between the  $M$  vector in the film and the current flowing through the film. Figure 6 illustrates this property. The film resistance is the greatest when the current flows parallel to the  $M$  vector.

If an external magnetic field is applied normal to the side of the film, the Magnetization vector will rotate and change the angle  $\theta$ . This will cause the resistance value to vary ( $\Delta R/R$ ) and produce a voltage output change in the Wheatstone bridge. This change in the Permalloy is termed the magnetoresistive effect and is directly related to the angle of the current flow and the magnetization vector.

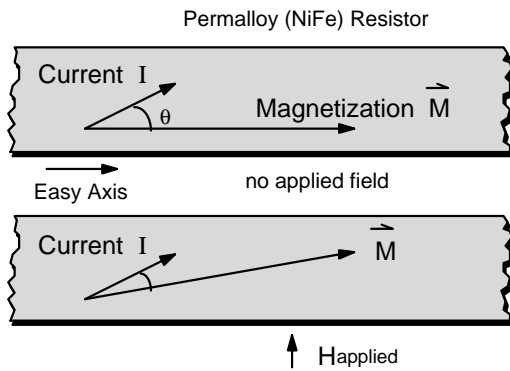

Figure 6. Magneto-resistive Effect

Note in Figure 7 that the  $\Delta R/R$  change in resistance is symmetric about the angle  $\theta$  axis and that there is a linear region about the 45-degree angle. The method used to cause the current to flow at a 45-degree angle in the film is called barber pole biasing. This is accomplished through a layout technique by placing low resistance shorting bars across the film width. The current prefers to take the shortest path through the film, thus causing it to flow from one bar to the next at a 45-degree angle. Figure 8 illustrated this effect for all four resistors in a simple Wheatstone bridge.

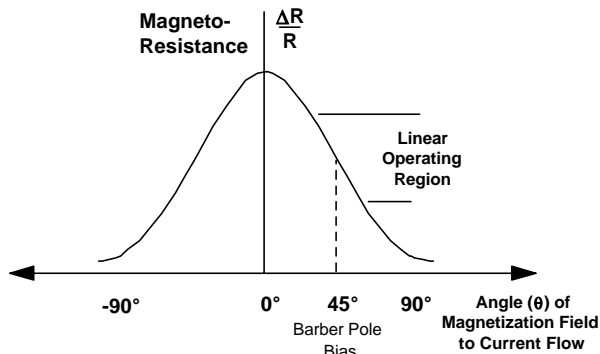

Figure 7. Magneto-resistive Variation with Angle Theta

The magneto-resistive characteristic of the Permalloy causes a resistance change ( $\Delta R$ ) in the bridge induced by the presence of an applied magnetic field. This causes a corresponding change in voltage output as shown in Figure 5. The sensitivity of the bridge is often expressed as  $mV/V/Oe$ . The middle term ( $V$ ) of this unit refers to the bridge voltage,  $V_b$ . When the bridge voltage ( $V_b$ ) is set to 5 volts, and the sensitivity ( $S$ ) is  $3mV/V/Oe$ , then the output gain will be  $15mV/Oe$ . Through careful selection of a bridge amplifier, output levels of 1 microvolt can be achieved. This results in a magnetic resolution of 67 microoersted, or 1 part in 15,000 per oersted. If the bridge output is amplified by

a gain of 67, then the total output sensitivity would be  $1V/gauss$  ( $=67 \times 15 mV/gauss$ ). If a full-scale range of  $\pm 2$  gauss is desired, this implies a 4 volt output swing centered on the 2.5V bridge center value—or a span of 0.5 to 4.5V. This signal level is suitable for most A/D converters. Using an AMR sensor and amplifier, precise magnetic field information can be derived that provide field magnitude as well as directional information.

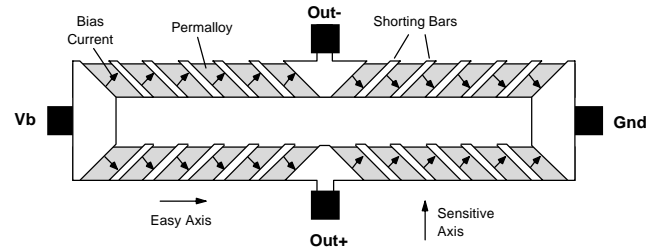

Figure 8. AMR Barber Pole Bias

A concern for any magnetic sensor made of ferromagnetic material is the exposure to a disturbing magnetic field. For AMR sensors, this disturbing field actually breaks down the magnetization alignment in the Permalloy film that is critical to the sensor operation. The direction and magnitude of vector  $M$  is essential to repeatable, low noise, and low hysteresis output signals. The top film in Figure 9 illustrates the AMR film when exposed to a disturbing magnetic field. The Permalloy strip is broken up into random oriented magnetic domains that degrades the sensor operation shown in Figure 6.

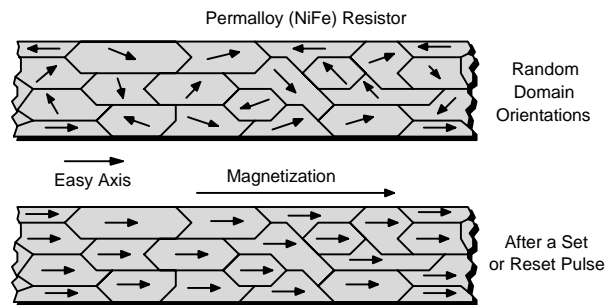

Figure 9. Magnetic Domain Orientation in AMR Thin Films

To recover the magnetic state, a strong magnetic field must be applied along the length of the Permalloy film. Within tens of nanoseconds the random domains will line up along the easy axis as shown in the lower film of Figure 9. Now the  $M$  vector is restored and the predictable magneto-resistive effect will occur. The  $M$  vector will stay in this state for years as long as there is no magnetic disturbing field present.

A common method used to realign these domains is to use a coil around the Wheatstone bridge resistors. Switching a high current pulse through the coil (Figure 10) will create a large magnetic field of 60-100 gauss and restore the M vector [9]. This process is referred to as flipping the magnetic domains with a set pulse. This flipping action will also take place for a pulse in the opposite direction through this external coil. In this case, the reset pulse, the domains will all point in the opposite direction along the easy axis. The KMZ-10A AMR sensor from Philips requires an external coil around the package to create the set and reset fields.

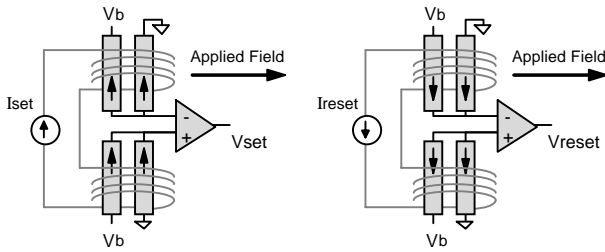

Figure 10. Set and Reset Flipping Circuits

Honeywell's family of AMR sensor has a patented on-chip strap that replaces the external coil to create the set and reset field effects.

#### Offset Reduction in AMR sensors

Before addressing specific applications it is useful to understand how to operate the AMR sensor. Specifically, undesirable effects are inherent in the sensor that may interfere with magnetic field sensing such as bridge offset voltages and temperature effects. This section addresses these concerns and describes techniques to perform automatic gain adjustment and real-time offset cancellation.

Additional benefits to using a set/reset pulse besides restoring the sensor properties after exposure to a high magnetic field. Figure 11 shows the transfer curves for a sensor after it has been set, and then reset, shows an inversion of the gain slope and a common crossover point on the bridge output axis. This crossover point is the zero field bridge offset voltage. For the sensor in Figure 11, the bridge offset is around  $-3$  mV. This is due to the resistor mismatch during the manufacture process. This offset voltage is usually not desirable and can be reduced, or eliminated, using one of four techniques described below.

**MANUAL OFFSET TRIM**—The most straightforward technique for offset reduction is to add a parallel trim resistor across one leg of the bridge to force both out-

puts to the same voltage. This must be done in a zero magnetic field environment, usually in a zero gauss chamber. It is labor intensive since each sensor may require a different value trim resistor.

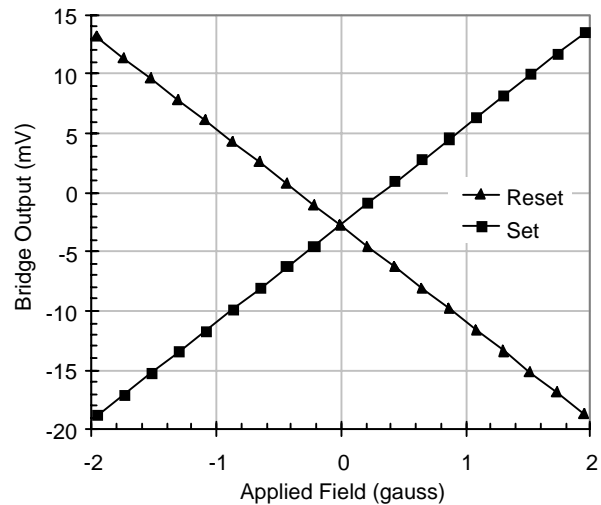

Figure 11. Set and Reset Output Transfer Curves

**OFFSET STRAP**—Another method of removing the offset voltage is by using a coil to create a field in the sensitive axis direction. Static current through this coil can be set to null the bridge offset by adding or subtracting a field equal to the offset voltage. Honeywell's family of AMR sensors has a patented on-chip offset strap to accomplish offset adjustment. Again, the offset current must be determined in a zero gauss environment and requires a constant dc source. In this paper, further references to the offset strap will imply either the on-chip strap or an external coil.

**SET/RESET WITH MICROPROCESSOR**—A third method to cancel the bridge offset ( $V_{os}$ ) is by using numerical subtraction. To measure a field  $H_{applied}$ , first activate a set pulse, see Figure 12. Then, after it has settled, take a reading and store it as  $V_{set}$ . Repeat these steps for a reset pulse and store the reading as  $V_{reset}$ . The expressions for these two readings, and their difference, are:

$$V_{set} = S * H_{applied} + V_{os} \quad (1)$$

$$V_{reset} = -S * H_{applied} + V_{os} \quad (2)$$

$$V_{set} - V_{reset} = 2 * S * H_{applied} \quad (3)$$

Note that in equation (3) there is no  $V_{os}$  term and the desired field,  $H_{applied}$ , is doubled. The benefit of offset cancellation using this method is that any temperature drift of the bridge offset, including the amplifier, is

eliminated! This is a powerful technique and easy to implement if the readings are controlled by a microprocessor.

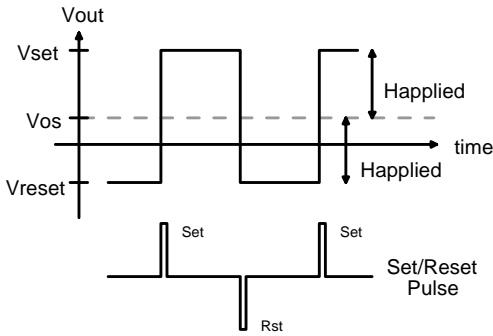

Figure 12. Set/Reset Effect On Bridge Output

A variation of this third method is to add  $V_{set}$  and  $V_{reset}$  instead of subtracting them; the result is  $2 \cdot V_{os}$ . This approach can be used to periodically check the offset voltage, say during power-on cycle or once every 10 minutes. The  $V_{os}$  can then be subtracted from all subsequent readings. This will allow increased input signal bandwidth and help reduce power consumption.

**ELECTRONIC FEEDBACK**—A fourth method to eliminate the bridge offset is to do it electronically using a feedback amplifier (see Figure 13). The basis of operation is to modulate the sensor input signal to a higher frequency, remove the offset, and then demodulate it back to a dc voltage. This can be accomplished by using the set/reset switching property shown in Figure 10. By using a square wave of frequency 200 Hz to alternately create set and reset pulses, the bridge output voltage will switch between  $V_{set}$  and  $V_{reset}$  as described in equations (1) and (2). This switching of  $V_{out1}$  helps to reduce the signal noise by modulating the low frequency signals of interest to a higher band, away from the  $1/f$  noise, and where the flatband noise is minimal. Before the output of amplifier #1 is connected, the intermediate signal,  $V_{out1}$ , is in the form of a square wave with amplitude related to  $2 \cdot H_{applied}$  and an offset level of  $V_{os}$  as shown in Figure 12.

Amplifier #1 is designed with a low pass frequency response so that its output will not follow the 200 Hz square wave from the bridge. Instead, it will output a negative dc level corresponding to the  $V_{os}$  of the bridge and any offset of amplifier #2. When this signal is connected to the (+) input of amplifier #2, it cancels these offsets. Now, the intermediate signal  $V_{out1}$  is in the form of a square wave with amplitude related to  $2 \cdot H_{applied}$  and centered around  $V_{ref}$ . By using a selectable  $\pm 1$  gain block controlled by  $V_{set/reset}$ , the output signal,  $V_{demod}$ , will be demodulated. This pro-

duces a dc level that is directly proportional to  $H_{applied}$ . An additional low pass filter ( $\sim 10$  Hz) should filter the  $V_{demod}$  signal to eliminate any residual switching noise at frequency 400 Hz out of the demodulator. This circuit has very low temperature drift since the bridge offset and temperature variations are continuously being cancelled as well as the offset and temperature effects of the bridge amplifier. The magnetic signal bandwidth is somewhat limited to 10 Hz for this example.

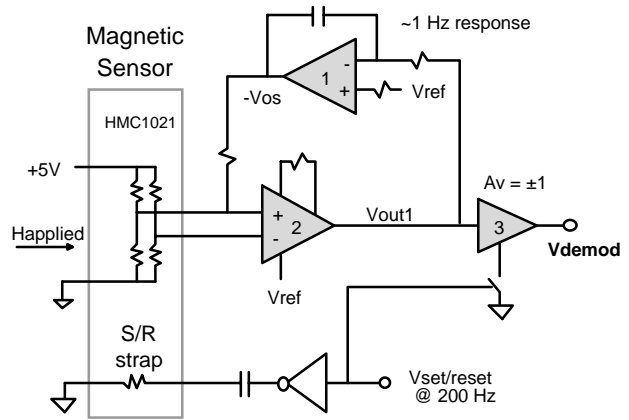

Figure 13. Electronic Feedback for Offset Reduction

### Compensating for hard iron effects

Any external magnetic field can be canceled by driving a defined current through the offset strap. This is useful for eliminating the effects of stray hard iron distortion of the Earth's magnetic field. For example, reducing the effects of a car body on the Earth's magnetic field in an automotive compass application. If the MR sensor is in a fixed position within the automobile, the effect of the car on the Earth's magnetic field can be approximated as a shift, or offset, field. If this shift in the Earth's field can be determined, then it can be compensated for by applying an equal and opposite field using the offset strap.

### In-circuit gain calibration

The offset strap can also be used to auto-calibrate the AMR bridge while in the application during normal operation. This is useful for occasionally checking the bridge gain for that axis or to make adjustments over a temperature drift. This can be done during power-up or anytime during normal operation. The concept is simple; take two points along a line and determine the slope of that line—the gain. When the bridge is measuring a steady applied magnetic field the output will remain constant. Record the reading for the steady field and call it  $H_1$ . Now apply a known current through the offset strap and record that reading as  $H_2$ . This can

be as simple as switching a 1 kohm resistor in series with the offset strap using a microprocessor output. The current through the offset strap will cause a change in field the MR sensor measures—call that the delta applied field ( $\Delta H_a$ ). The AMR sensor gain is then computed as:

$$\text{AMRgain} = (H_2 - H_1) / \Delta H_a$$

#### Closed-loop circuit for precision measurements

The offset strap can be used as a feedback element in a closed loop circuit—Figure 14. Using the offset strap in a current feedback loop can produce desirable results for measuring magnetic fields. To do this, connect the output of the bridge amplifier to a low pass filter driver connected to the offset strap. Using high gain and negative feedback in the loop, this will create a canceling, or offsetting, magnetic field that will drive the AMR bridge output to zero. The resultant current through the offset strap indicates how strong the field is being cancelled. This current is measured using a resistor,  $R_{\text{sense}}$ , which generates an output voltage,  $V_{\text{sense}}$ . This method gives extremely good linearity and temperature characteristics. The idea in this circuit is to always operate the AMR bridge in the balanced resistance mode. That is, no matter what magnetic field is being measured, the current through the offset strap will cancel it out. The bridge always “sees” a zero field condition. The resultant offset current required to cancel the applied field is a direct measure of that field strength and can be translated into the field value.

There are many other uses for the offset strap than those described here. The key point is that the ambient field and the offset field simply add to one another and are measured by the AMR sensor as a single field.

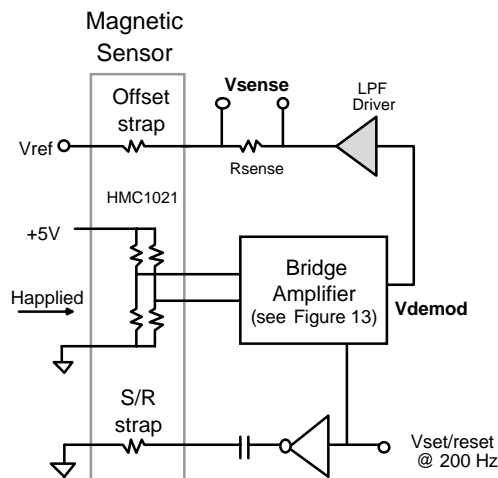

Figure 14. Closed-Loop Circuit with AMR Sensor

## BIAS MAGNET FIELD SENSORS *(above 10 gauss)*

Most industrial sensors use permanent magnets as a source of the detected magnetic field. These permanent magnets magnetize, or bias, ferromagnetic objects close to the sensor. The sensor then detects the change in the total field at the sensor. Bias field sensors not only must detect fields which are typically larger than the Earth's field, but they also must not be permanently affected or temporarily upset by a large field. Sensors in this category include reed switches, InSb magnetoresistors, Hall devices, and GMR sensors. Although some of these sensors, such as magnetoresistors, are capable of measuring fields up to several teslas, others such as GMR sensors can detect fields down to the milligauss region with research extending their capabilities to the microgauss region.

### Reed Switches

Possibly the simplest magnetic sensor which produces a useable output for industrial control is the reed switch. It consists of a pair of flexible, ferromagnetic contacts hermetically sealed in an inert gas filled container, often glass. The magnetic field along the long axis of the contacts magnetizes the contacts causing them to attract one another closing the circuit. There is usually considerable hysteresis between the closing and releasing fields so they are quite immune to small fluctuations in the field.

Reed switches are maintenance free and have a high immunity to dirt and contamination. Rhodium plated contacts insure long contact life. Typical capabilities are 0.1 to 0.2 A switching current and 100 to 200 V switching voltage. Contact life is measured at  $10^6$  to  $10^7$  operations at 10 mA. Reed switches are available with normally open (NO), normally closed (NC), and class C (SPDT) contacts. Latching reed switches are also available. Mercury wetted reed switches can switch currents as high as 1 A and have no contact bounce.

Low cost, simplicity, reliability, and zero power consumption make reed switches popular in many applications. A reed switch together with a separate small permanent magnet make a simple proximity switch often used in security systems to monitor the opening of doors or windows. The magnet, affixed to the moveable part, activates the reed switch when it comes close enough. The desire to sense almost everything in cars is increasing number of reed switch sensing applications in the automotive industry.



### Lorentz Force Devices

There are several sensors that utilize the Lorentz force, or Hall effect, on charge carriers in a semiconductor. The Lorentz Force equation describes the force  $\underline{FL}$  experienced by a charged particle with charge  $q$  moving with velocity  $\underline{v}$  in a magnetic field  $\underline{B}$ .

$$\underline{FL} = q(\underline{v} \times \underline{B}).$$

Since the quantities  $\underline{FL}$ ,  $\underline{v}$ , and  $\underline{B}$  are vector quantities, they have both magnitude and direction. The Lorentz force is proportional to the cross product between the vectors representing velocity and magnetic field so it is perpendicular to both of them and, for a positively charge carrier, has the direction of advance of a right-handed screw rotated from the direction of  $\underline{v}$  towards the direction of  $\underline{B}$ . The acceleration caused by the Lorentz force is always perpendicular to the velocity of the charged particle; therefore, in the absence of any other forces, a charge carrier follows a curved path in a magnetic field.

The Hall Effect is a consequence of the Lorentz force in semiconductor materials. When a voltage is applied from one end of a slab of semiconductor material to the other end, charge carriers start to flow. If at the same time a magnetic field is applied perpendicular to the slab, the current carriers are deflected to the side by the Lorentz force. Charge builds up along the side until the resulting electrical field produces a force on the charged particle sufficient to counteract the Lorentz force. This voltage across the slab perpendicular to the applied voltage is called the Hall Voltage. Figure 15 is a schematic of the geometry involved in the Hall effect.

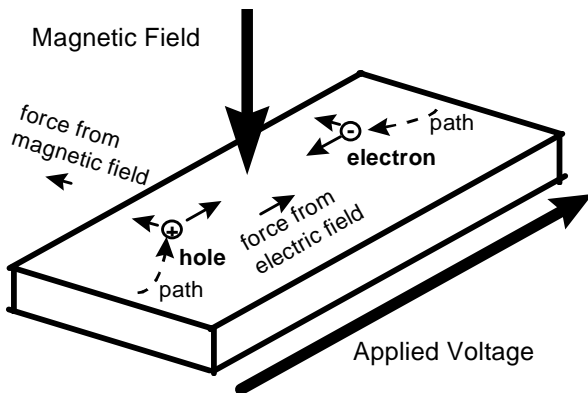

Figure 15. A semiconductor slab showing magnetic field, applied voltage, forces on electrons and holes, and paths of electrons and holes.

### Magnetoresistors

The simplest of Lorentz force devices are magnetoresistors using semiconductors such as InSb and InAs with high room-temperature carrier mobility. If a voltage is applied along the length of a thin slab of semiconductor material, a current will flow and a resistance can be measured. When a magnetic field is applied perpendicular to the slab, the Lorentz force will deflect the charge carriers. If the width of the slab is greater than the length, the charge carriers will cross the slab without a significant number of them collecting along the sides. The effect of the magnetic field is to increase the length of their path and, therefore, the resistance. An increase in resistance of several hundred percent is possible in large fields. In order to produce sensors with hundreds to thousands of ohms of resistance, long, narrow semi-conductor stripes a few  $\mu\text{m}$  wide are produced using photolithography. The required length to width ratio is accomplished by forming periodic low resistance metal shorting bars across the traces. Each shorting bar produces an equipotential across the semiconductor stripe. The result is, in effect, a number of small semiconductor elements with the proper length to width ratio connected in series. A second method is used in commercial devices manufactured by Siemens uses lapped wafers cut from boules which have needle shaped low resistance precipitates of NiSb in a matrix of InSb. These precipitates serve as the shorting bars on the current path. Notice that the higher the magnetic field the longer the current path and the higher the resistance.

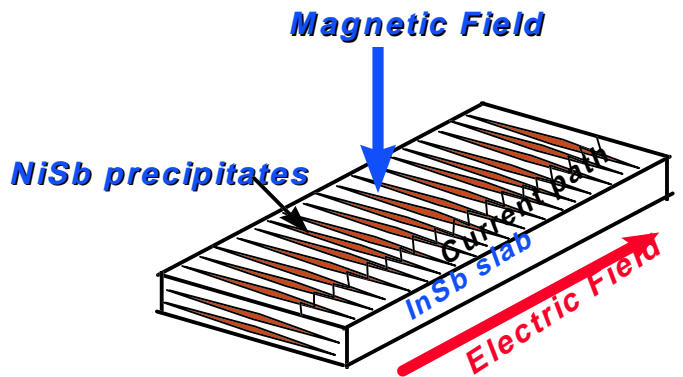

Figure 16. Schematic diagram of the current path in a slab of InSb with NiSb precipitates.

Magnetoresistors formed from InSb are relatively insensitive at low fields but exhibit large changes in resistance at high fields. The resistance changes approximately as the square of the field. They are sensitive only to the component of the magnetic field perpendicular to the slab and are not sensitive to whether the field is positive or negative. The large temperature coefficients of resistivity are caused by the change in mobility of the charge carriers with temperature. Sensors are made with either single resistors or pairs of spaced resistors. The second type is used to measure field gradients and is usually combined with external resistors to form a Wheatstone bridge. A permanent magnet is often incorporated in the field gradient sensor to bias the magnetoresistors up to a more sensitive part of their characteristic curve Figure 17 shows the change of resistance of a typical InSb sensor with field and temperature. Different doping levels of the semiconductor material account for the differences in characteristics as well as differences in conductivity—200 ( $\Omega\text{cm}$ )-1 for D material and 550 ( $\Omega\text{cm}$ )-1 for L material.

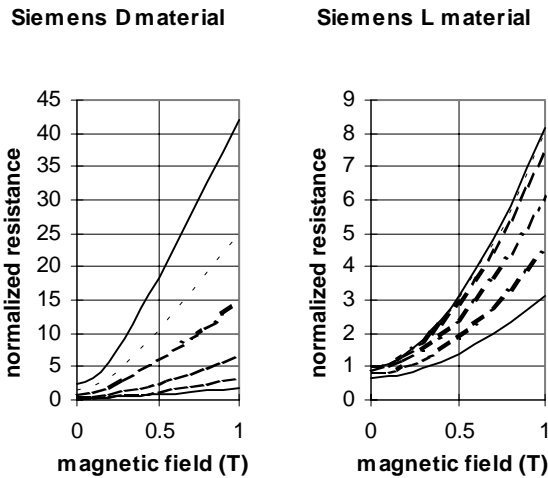

Figure 17. Resistance vs. field for an InSb magnetoresistors at different temperatures. Resistance is normalized to the resistance at zero field. Temperatures from top to bottom are: -20, 0, 25, 60, 90, and 120 °C.

### Hall Sensors

The second type of sensor, which utilizes the Lorentz force on charge carriers, is a Hall sensor. These devices predominantly use n-type silicon when cost is of primary importance and GaAs for higher temperature capability due to its larger band gap. In addition, InAs, InSb, and other semiconductor materials are gaining popularity due to their high carrier mobilities which re-

sult in greater sensitivity and in frequency response capabilities above the 10 to 20 kHz typical of Si Hall sensors. Compatibility of the Hall sensor material with semiconductor substrates is important since Hall sensors are often used in integrated devices which include other semiconductor structures.

A Hall sensor uses a geometry similar to that shown in Figure 15; however, in this case the length in the direction of the applied voltage is long compared to the width. Charge carriers are deflected to the side and build up until they create a Hall voltage across the slab whose force equals the Lorentz force on the charge carriers. At this point the charge carriers travel the length in approximately straight lines, and additional charge does not build up. Since the final charge carrier path is essentially along the applied electric field, the end-to-end resistance changes little with magnetic field. The Hall voltage is measured between electrodes placed at the middle of each side. This differential voltage is proportional to the magnetic field perpendicular to the slab. It also changes sign when the sign of the magnetic field changes. The ratio of the Hall voltage to the input current is called the Hall resistance, and the ratio of the applied voltage to the input current is called the input resistance.

The Hall resistance and Hall voltage increase linearly with applied field to several teslas (10s of kilogauss). The temperature dependence of the Hall voltage and the input resistance of Hall sensors are governed by the temperature dependence of the carrier mobility and that of the Hall coefficient. Different materials and different doping levels result in tradeoffs between sensitivity and temperature dependence. Figures 18 and 19 illustrate the temperature dependence of the input resistance and Hall voltage for several materials [11].

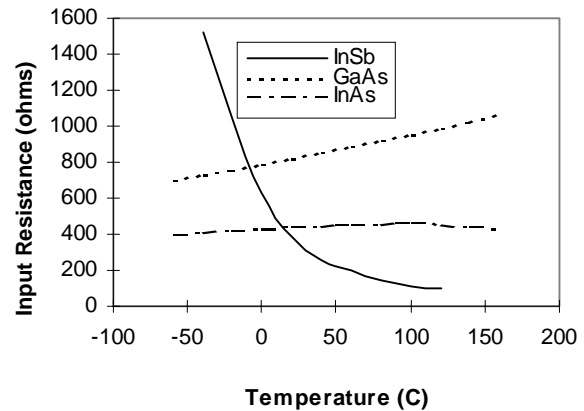

Figure 18. Input resistance of several Hall sensors with different semiconductor materials vs. temperature.

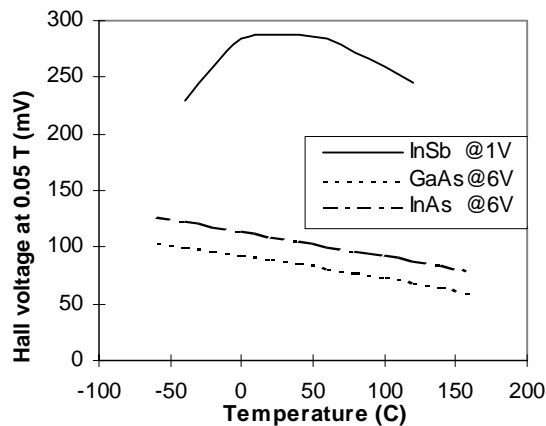

Figure 19. Hall voltage at 0.05 T (500 Oe) of several Hall sensors with different semiconductor materials vs. temperature. The input voltage is given for each material.

### Integrated Hall Sensors

Hall devices are often combined with semiconductor elements to make integrated sensors. By adding comparators and output devices to a Hall element manufactures provide unipolar and bipolar digital switches. Adding an amplifier increase the relatively low-voltage signals from a Hall device to produce ratiometric linear Hall sensors with an output centered on one half the supply voltage. Power usage can even be reduced to extremely low levels by using a low duty cycle [12].

### Giant Magnetoresistive (GMR) Devices

Large magnetic field dependent changes in resistance are possible in thin-film ferromagnet/non-magnetic metallic multilayers. This phenomenon was first observed in France in 1988 [13]. Changes in resistance with magnetic field of up to 70% were observed. Compared to the few percent change in resistance observed in anisotropic magnetoresistance (AMR), this phenomenon was truly giant magnetoresistance (GMR) The resistance of two thin ferromagnetic layers separated by a thin non-magnetic conducting layer can be altered by changing whether the moments of the ferromagnetic layers are parallel or antiparallel. Layers with parallel magnetic moments will have less scattering at the interfaces, longer mean free paths, and lower resistance. Layers with antiparallel magnetic moments will have more scattering at the interfaces, shorter mean free paths, and higher resistance. These differences are shown schematically in Figure 20. In order for spin dependent scattering to be a significant part of the total resistance, the layers must be thinner than the mean free path of electrons in the bulk material. For

many ferromagnets the mean free path is tens of nanometers, so the layers themselves must each be typically less than 10 nm (100 Å). It is not surprising, then, that GMR was only recently observed with the development of thin-film deposition systems.

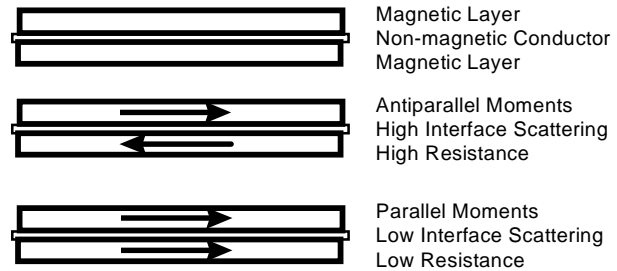

Figure 20. Scattering from two different alignment of magnetic moments in a GMR “sandwich” with two magnetic layers separated by a conducting non-magnetic layer.

Various methods of obtaining antiparallel magnetic alignment in thin ferromagnet-conductor multilayers as shown in Figure 20 have been discussed elsewhere [14-16]. The structures currently being used in GMR sensors are unpinned sandwiches and antiferromagnetic multilayers although spin valves are of considerable interest especially for magnetic read heads.

**Unpinned sandwich GMR** materials consist of two soft magnetic layers of iron, nickel and cobalt alloys separated by a layer of a non-magnetic conductor such as copper. With magnetic layers 4 to 6 nm (40 to 60 Å) thick separated by a conductor layer typically 3 to 5 nm thick there is relatively little magnetic coupling between the layers. For use in sensors, sandwich material is usually patterned into narrow stripes. The magnetic field caused by a current of a few mA per  $\mu\text{m}$  of stripe width flowing along the stripe is sufficient to rotate the magnetic layers into antiparallel or high resistance alignment. An external magnetic field of 3 to 4 kA/m (35 to 50 Oe) applied along the length of the stripe is sufficient to overcome the field from the current and rotate the magnetic moments of both layers parallel to the external field. A positive or negative external field parallel to the stripe will both produce the same change in resistance. An external field applied perpendicular to the stripe will have little effect due to the demagnetizing fields associated with the extremely narrow dimensions of these magnetic objects. The value usually associated with the GMR effect is the percent change in resistance normalized by the saturated or minimum resistance. Sandwich materials have values of GMR typically 4 to 9 % and saturate with 2.4 to 5 kA/m (30 to 60 Oe) applied field. Figure 21 shows a typical resistance vs. field plot for sandwich GMR material.

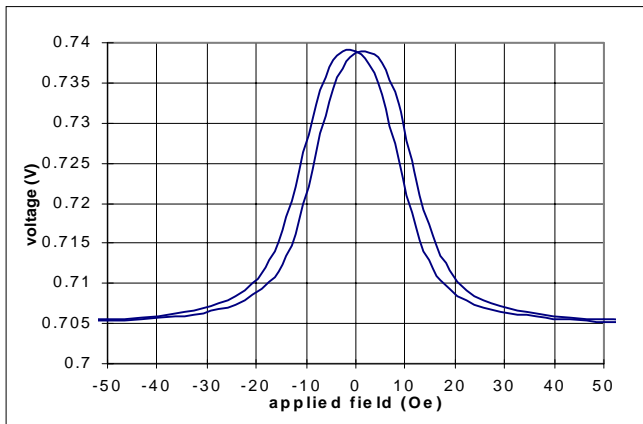

Figure 21. Voltage vs. applied field for a 2  $\mu\text{m}$  wide stripe of unpinned sandwich GMR material with 1.5 mA current. GMR = 5 %.

**Antiferromagnetic multilayers** consist of multiple repetitions of alternating conducting magnetic layers and non-magnetic layers. Since multilayers have more interfaces than do sandwiches, the size of the GMR effect is larger. The thickness of the non-magnetic layers is less than that for sandwich material (typically 1.5 to 2.0 nm) and the thickness is critical. Only for certain thicknesses, the polarized conduction electrons cause antiferromagnetic coupling between the magnetic layers. Each magnetic layer has its magnetic moment antiparallel to the moments of the magnetic layers on each side—exactly the condition needed for maximum spin dependent scattering. A large external field can overcome the coupling which causes this alignment and can align the moments so that all the layers are parallel—the low resistance state. If the conducting layer is not the proper thickness, the same coupling mechanism can cause ferromagnetic coupling between the magnetic layers resulting in no GMR effect.

A plot of resistance vs. applied field for a multilayer GMR material is shown in Figure 22. Note the higher GMR value, typically 12 to 16 %, and the much higher external field required to saturate the effect, typically 20 kA/m (250 Oe). Multilayer GMR materials have better linearity and lower hysteresis than typical sandwich GMR material.

**Spin valves**, or antiferromagnetically pinned spin valves, are similar to the unpinned spin valves or sandwich materials described earlier. An additional layer of an antiferromagnetic material is provided on the top or the bottom. The antiferromagnetic material such as FeMn or NiO couples to the adjacent magnetic layer and pins it in a fixed direction. The other magnetic layer is free to rotate. These materials do not require the field from a current to achieve antiparallel alignment

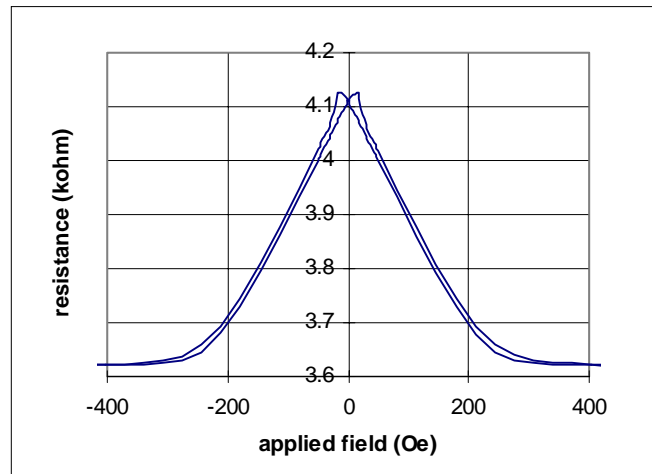

Figure 22. Resistance vs. applied field for a 2  $\mu\text{m}$  wide stripe of antiferromagnetically coupled multilayer GMR material. GMR = 14 %.

or a strong antiferromagnetic exchange coupling to adjacent layers. The direction of the pinning layer is usually fixed by elevating the temperature of the GMR structure above the blocking temperature. Above this temperature, the antiferromagnet is no longer coupled to the adjacent magnetic layer. The structure is then cooled in a strong magnetic field which fixes the direction of the moment of the pinned layer. If the spin valve material is heated above its blocking temperature, it can lose its orientation. The operating temperature of a spin valve sensor is limited to below its blocking temperature. Since the change in magnetization in the free layer is due to rotation rather than domain wall motion, hysteresis is reduced. Values for GMR are 4 to 20 % and saturation fields are 0.8 to 6 kA/m (10 to 80 Oe).

Spin valves are receiving a high level of research interest due to their potential for use in magnetic read heads for high density data storage applications [17]. IBM has announced the introduction of a 16.8 gigabyte hard drive with a spin valve read head. Bridge sensor designs using spin valve materials have also been described in the literature [18] and rotational position sensors in a product bulletin [19].

**Spin dependent tunneling (SDT)** structures are very similar to those shown in Figure 20 except that an extremely thin insulating layer is substituted for the conductive interlayer separating the two magnetic layers. The conduction is due to quantum tunneling through the insulator. The size of the tunneling current between the two magnetic layers is modulated by the direction between the magnetization vectors in the two layers [20]. The conduction path must be perpendicular to the plane of the GMR material since there is such a large difference between the conductivity of the tunneling

path and that of any path in the plane. Extremely small SDT devices several  $\mu\text{m}$  on a side with high resistance can be fabricated using photolithography allowing very dense packing of magnetic sensors in small areas. Although these recent materials are very much a topic of current research, values of GMR of 10 to 25 % have been observed. The saturation fields depend upon the composition of the magnetic layers and the method of achieving parallel and antiparallel alignment. Values of saturation field range from 0.1 to 10 kA/m (1 to 100 Oe) offering the possibility of extremely sensitive magnetic sensors with very high resistance suitable for battery operation.

**Colossal Magnetoresistance** Scientists, to surpass the term giant, have proceeded on to colossal magnetoresistance materials (CMR). Under certain conditions these mixed oxides undergo a semiconductor to metallic transition with the application of a magnetic field of a few tesla (10s of kilogauss). The size of the resistance ratios, measured at  $10^3$  to  $10^8$  %, have generated considerable excitement even though they required high fields and liquid nitrogen temperatures. Recently academic groups have developed CMR materials which work at room temperature and fabricated Wheatstone bridge topology sensors out of these materials [21]. These CMR materials are still a long ways from commercial applications but are a new development to watch.

### GMR Circuit Techniques

To date the best utilization of GMR materials for magnetic field sensors has been in Wheatstone bridge configurations, although simple GMR resistors and GMR half bridges can also be fabricated. A sensitive bridge can be fabricated from four photolithographically patterned GMR resistors, two of which are active elements. These resistors can be as narrow as  $2 \mu\text{m}$  allowing a serpentine 10 k $\Omega$  resistor to be patterned in an area as small as  $100\mu\text{m}$  by  $100\mu\text{m}$ . The vary narrow width also makes the resistors sensitive only to the component of magnetic field along their long dimension. Small magnetic shields are plated over two of the four equal resistors in a Wheatstone bridge protecting these resistors from the applied field and allowing them to act as reference resistors. Since they are fabricated from the same material, they have the same temperature coefficient as the active resistors. The two remaining GMR resistors are both exposed to the external field. The bridge output is therefore twice the output from a bridge with only one active resistor. The bridge output for a 10 % change in these resistors is approximately 5 % of the voltage applied to the bridge.

Additional permalloy structures are plated onto the substrate to act as flux concentrators. The active re-

sistors are placed in the gap between two flux concentrators as is shown in Figure 23. These resistors experience a field which is larger than the applied field by approximately the ratio of the gap between the flux concentrators, D1, to the length of one of the flux concentrators, D2. In some sensors the flux concentrators are also used as shields by placing two resistors beneath them as is shown for R3 and R4. The sensitivity of a GMR bridge sensor can be adjusted in design by changing the lengths of the flux concentrators and the gap between them. In this way, a GMR material which saturates at approximately 300 Oe can be used to build different sensors which saturate at 15, 50, and 100 Oe. To produce sensors with even more sensitivity, external coils and feedback can be used to produce sensors with resolution in the 100 mA/m or milli-gauss range.

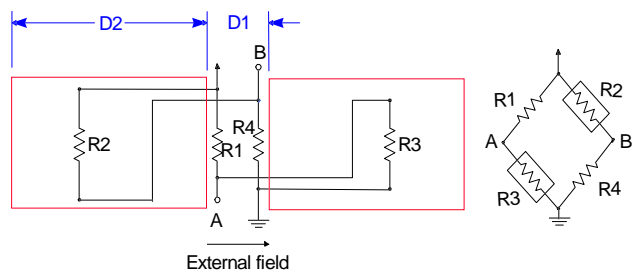

Figure 23. Configuration of GMR resistors in a Wheatstone bridge sensor. Flux concentrators are shown: D1 is the lengths of the gap between the flux concentrators, and D2 is the length of one flux concentrator.

Smart sensors with both sensing elements and associated electronics such as amplification and signal conditioning on the same die are the latest trend in modern sensors. GMR materials are deposited on wafers with sputtering systems and can, therefore, be directly integrated with semiconductor processes. The small size sensing elements fit well with the other semiconductor structures and are applied after most of the semiconductor fabrication operations are complete. Due to the topography introduced by the many layers of polysilicon, metal, and oxides over the transistors, areas must be reserved with no underlying transistors or connections. These areas will have the GMR resistors. The GMR materials are actually deposited over the entire wafer, but the etched sensor elements remain only on these reserved, smooth areas on the wafers [22].

Functions included in an integrated sensor include regulated voltage or current supplies to the sensor elements; threshold detection to provide a switched output when a preset field is reached, amplifiers, logic functions including divide by 2 circuits; and various options for outputs. Using such elements, a two-wire sensor can be designed which has two current levels—a low current level when the field is below a threshold and a high current level when the field is above the threshold.

On-board sensor electronics can increase signal levels to significant voltages with the least pickup of interference. It is always best to amplify low-level signals close to where they are generated. Converting analog signals to digital (switched) outputs within the sensor is another method of minimizing electronic noise. The use of comparators and digital outputs makes the non-linearity in the output of sandwich GMR materials of less concern. Even the hysteresis in such materials can be useful, since some hysteresis is usually built into comparators to avoid multiple triggering of the output due to noise. Figure 24 shows the circuit diagram and output characteristics for a commercial digital GMR sensor.

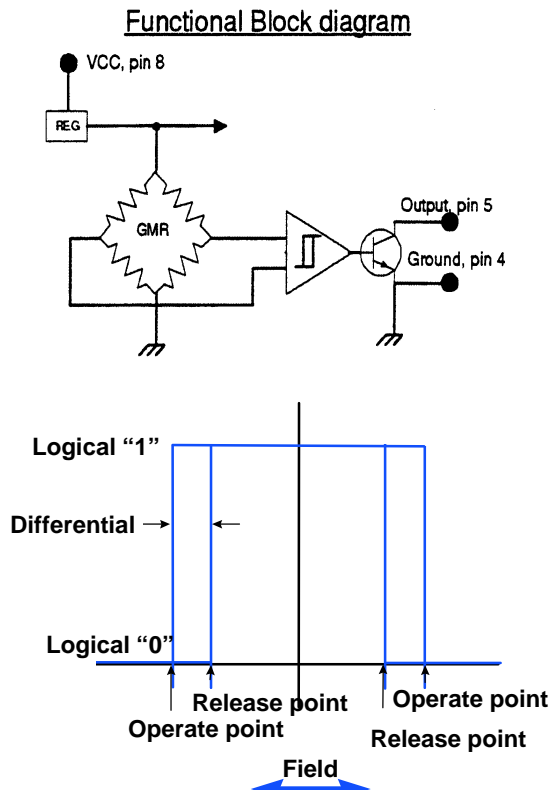

Figure 24. The schematic diagram and logic output characteristic of an integrated digital GMR sensor.

GMR materials have been successfully integrated with both BiCMOS semiconductor underlayers and bipolar semiconductor underlayers. The wafers are processed with all but the final layer of connections made. GMR material is deposited on the surface and patterned followed by a passivation layer. Windows are cut through the passivation layer to allow contact to both the upper metal layer in the semiconductor wafer and to the GMR resistors. The final layer of metal is deposited and patterned to interconnect the GMR sensor elements and to connect them to the semiconductor underlayers. The final layer of metal also forms the pads to which wires will be bonded during packaging. A final passivation

layer is deposited, magnetic shields and flux concentrators are plated and patterned, and windows are etched through to the pads.

## GMR SENSOR APPLICATIONS

### Proximity Detection

A magnetic field sensor can directly sense a magnetic field from a permanent magnetic, an electromagnet, or a current. In sensing the presence of a ferrous object, a biasing magnet is often used. The biasing magnet magnetizes the ferromagnetic object such as a gear tooth, and the sensor detects the combined magnetic fields from the magnetized object and the biasing magnet. A biasing magnet is affixed to the sensor in a position such that its direct influence on the sensor is minimal. Usually the biasing magnet is mounted on the top of the sensor with its magnetic axis perpendicular to the sensitive axis of the sensor. The biasing magnet can be centered such that there is little or no field in the sensitive direction of the sensor. In this way a reasonable large biasing magnet can be used. Occasionally a spacer is used between the sensor and the magnet to reduce the field at the sensor and, therefore, reduce how critically the magnet must be positioned. Figure 25 shows the relative positions of a sensor and a biasing magnet. The magnetic field lines are shown both in the absence and presence of a ferromagnetic object. Note the induced magnetic moment in the ferromagnetic object.

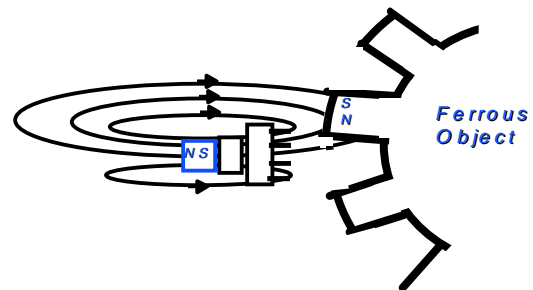
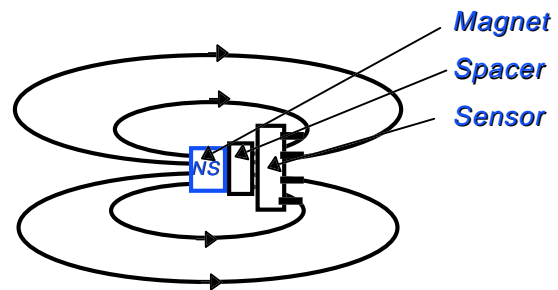

Figure 25. Side view of biasing magnet and sensor in 8 pin package shown with and without a ferrous object present.

The technique of using a biasing magnet is customarily used only if the ferrous object is in close proximity. It is difficult to magnetize an object several meters away using the field from a sensor-sized permanent magnet. The field from a dipole magnet falls off at the reciprocal of the distance cubed. In some applications such as detection of motor vehicles, the Earth field acts as a biasing magnet resulting in a magnetic signature from various parts of the car which are magnetized by the Earth's field. One such application is the counting and classification of motor vehicles passing over portable or permanent sensors in the road. Small, low-powered GMR sensors allow the sensors, electronics, memory, and battery to be packaged in a low-profile, protective, aluminum housing the size of your hand [23]. A second application in which the biasing magnet is not mounted on the sensor is currency detection. The particles in the ink on many countries' currency have ferromagnetic properties. Bills are passed over a permanent magnet array and magnetized along their direction of travel. A magnetic sensor located several inches away with its sensitive axis parallel to the direction of travel can detect the remnant field of the ink particles. The purpose of the biasing magnet in this case is to achieve a controlled orientation of the magnetic moments of the ink particles resulting in a maximum and recognizable magnetic signature. Reversing the magnetizing field can actually invert the signature.

### **Displacement Sensing**

GMR bridge sensors can be effectively employed to provide position information from small displacements associated with actuating components in machinery, proximity detectors, and linear position transducers. Due to the nonlinear characteristic of dipole magnetic fields produced by permanent magnets, the range of linear output may be limited. Figure 26 shows the position and motion of two sensors with differing sensitive axis directions relative to a cylindrical permanent magnet. The sensitive axis of the sensor is indicated by the double headed arrow on each sensor. The rate of change of the component of the magnetic field along the sensitive axis for each sensor is shown superimposed on the line of motion. Note that the field for the lower sensor changes direction and is negative in the center and positive at both ends.

### **Rotational Reference Detection**

GMR sensors offer a rugged, low cost solution to rotational reference detection. High sensitivity and dc operation afford the GMR bridge sensor an advantage over inductive sensors which have very low outputs at low frequencies and can generate large noise signals when subjected to high frequency vibrations. GMR

sensors are field sensors and do not measure the induced signal from the time rate of change of fields, as do variable reluctance sensors. The output from a GMR bridge sensor will have a minimum when the sensor is centered over a tooth

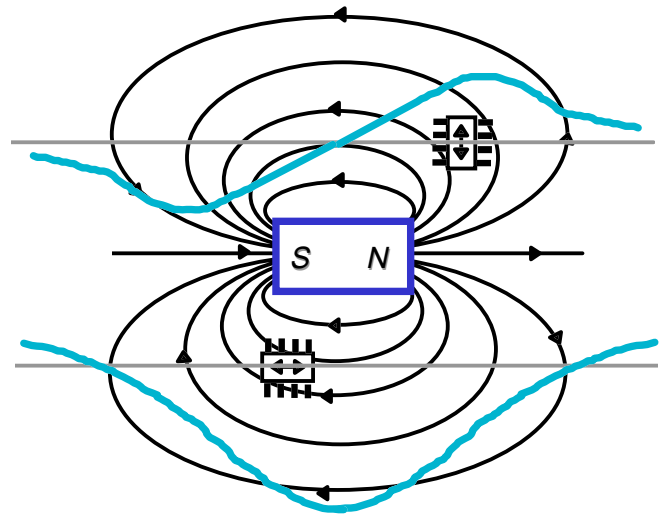

Figure 26. Sensors positioned to measure displacement relative to a permanent dipole magnet. Sensitive axes are indicated and the component of field along the sensitive axes for the two sensor are graphed.

or a gap and a maximum when a tooth approaches or recedes. Figure 25 illustrates a bridge sensor in position for angular position sensing.

### **Current Sensing**

Currents in wires create magnetic fields surrounding the wires or traces on printed wiring boards. The field decreases as the reciprocal of the distance from the wire. GMR bridge sensors can be effectively employed to sense this magnetic field. Both dc and ac currents can be detected in this manner. Bipolar ac current will be rectified by the sensors omnipolar sensitivity unless a method is used to bias the sensor away from zero. Unipolar and pulsed currents can be measured with good reproduction of fast rise time components due to the excellent high frequency response of the sensors. Since the films are extremely thin, response to frequencies up to 100 megahertz is possible. Figure 27 shows the relative position of a GMR bridge sensor and a current carrying wire to detect the current in the wire. A wire placed immediately over or under the sensor will produce a field of approximately 0.080 A/m (one mOe)

per mA of current. The sensor can also be mounted immediately over a current carrying trace on a circuit board. High currents may require more separation between the sensor and the wire to keep the field within the sensor's range. Low currents may be best detected with the current being carried by a trace on the chip immediately over the GMR resistors.

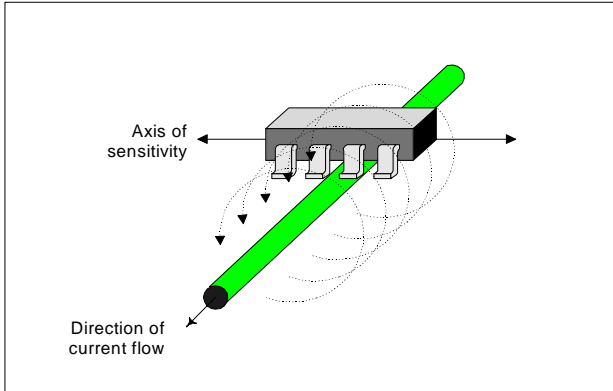

Figure 27. Proper orientation of a GMR bridge sensor to detect the magnetic field created by a current carrying wire.

### AMR SENSOR APPLICATIONS

AMR sensors available today do an excellent job of sensing magnetic fields within the Earth's field—below 1 gauss. These sensors are used in applications for detecting ferrous objects such as planes, train, and automobiles that disturb the Earth's field. Other applications include magnetic compassing, rotational sensing, current sensing, underground drilling navigation, linear position sensing, yaw rate sensors, and head tracking for virtual reality.

#### Vehicle Detection

The Earth's field provides a uniform magnetic field over a wide area—say several kilometers<sup>2</sup>. Figure 28 shows how a ferrous object, a car, creates a local disturbance in this field whether it is moving or standing still. AMR magnetic sensors can detect the change in the Earth's field due to the vehicle disturbance for many types of applications.

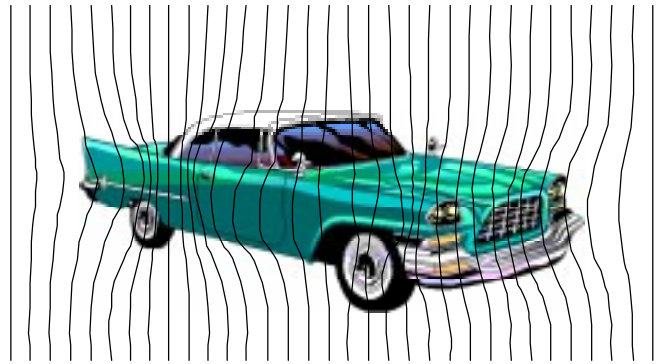

Figure 28. Vehicle Disturbance In Earth's Field  
Applications for vehicle detection can take several forms. A single axis sensor can detect if a vehicle is present, or not. The sensing distance from the vehicle can extend up to 15 meters away depending on its ferrous content. This may be useful for parking garages to give drivers entering it a choice of where the most available spaces to park. Another use is to detect approaching trains to control the crossing gates. In this application, two sensors could be used to detect presence, direction of travel, and speed.

Magnetic disturbances can be used for vehicle classification for toll road application. A three axis AMR magnetometer placed in the lane of traffic will provide a rich signal output for vehicle passing over it. Figure 29 shows a magnetometer output for three vehicles driving over it at roughly 1, 3, and 5 seconds on the time axis. The type of vehicle (car, truck, bus, etc) can be classified through pattern recognition and matching algorithms.

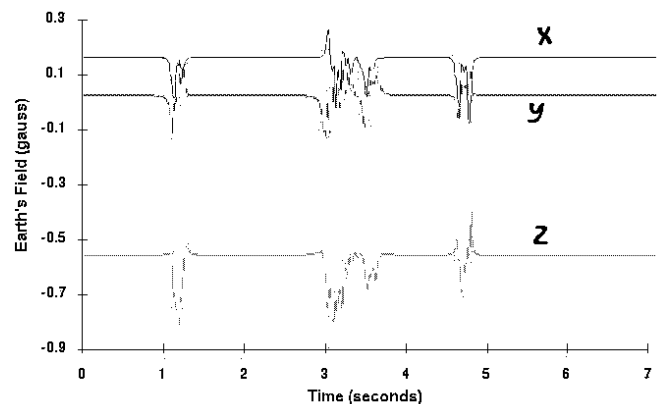

Figure 29. Magnetic Variations For Vehicle Detection



## Electronic Compass Using AMR Sensors

The Earth's magnetic field intensity is about 0.5 to 0.6 gauss and has a component parallel to the Earth's surface that always point toward magnetic north. This is the basis for all magnetic compasses. AMR sensors are best suited for electronic compasses since their range of sensitivity is centered within the earth's field [24].

The Earth's magnetic field can be approximated with the dipole model shown in Figure 30. This figure illustrates that the Earth's field points down toward north in the northern hemisphere, is horizontal and pointing north at the equator, and point up toward north in the southern hemisphere. In all cases, the direction of the Earth's field is always pointing to magnetic north. It is the components of this field that are parallel to the Earth's surface that are used to determine compass direction. The vertical portion of the Earth's magnetic field is ignored.

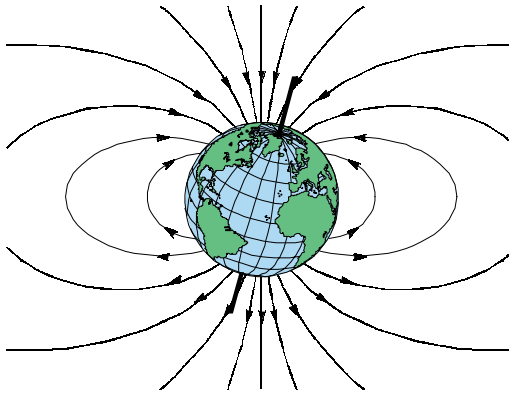

Figure 30. Earth's Magnetic Field Dipole Model

To achieve a one degree accurate compass requires a magnetic sensor that can reliably resolve angular changes to 0.1 degrees. The sensors must also exhibit low hysteresis (<0.05%FS), a high degree of linearity (<0.5%FS error) and be repeatable. The magnetic fields in the X and Y plane will typically be in the 200 to 300 milligauss range—more at the equator, less at the poles. Using the relationship:

$$\text{Azimuth} = \text{arcTan} (y/x) \quad (4)$$

the required magnetometer resolution can be estimated. To resolve a 0.18 change in a 200milligauss field would require a magnetic sensitivity of better than 0.35 milligauss. Solid state MR sensors are available today that reliably resolve 0.07 milligauss signals giving a five times margin of detection sensitivity.

Most often compasses are not confined to a flat and level plane. They are often hand held, attached to an aircraft, or on a vehicle in an uneven terrain. This makes it more difficult to determine the azimuth, or heading direction, since the compass is not always horizontal to the Earth's surface. Errors introduced by tilt angles can be quite large depending on the amount of the Dip angle. A typical method for correcting the compass tilt is to use an inclinometer, or tilt sensor, to determine the roll and pitch angles [25]. The terms roll and pitch are commonly used in aviation: roll refers to the rotation around the X, or forward direction, and pitch refers to the rotation around the y, or left-right, direction as in Figure 31.

Liquid filled tilt sensors, resembling a glass "thimble", use electrodes to monitor the fluid movement as the sensor changes angles. Newer solid state accelerometer tilt sensors are available that measure the Earth's gravitational field by means of an electromechanical circuit [26]. The output of these devices are an electrical signal equivalent to the angle of tilt.

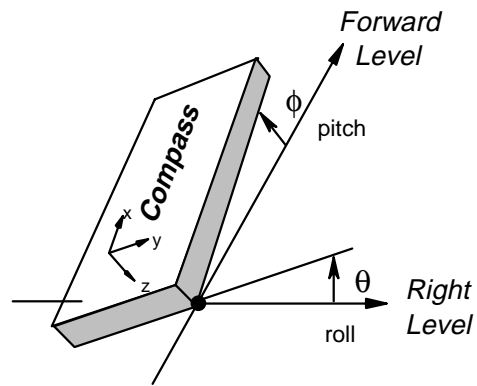

Figure 31. Compass Tilt Referenced To The Earth's Horizontal Plane

To compensate a compass for tilt, knowing the roll and pitch is only half the battle. The magnetometer must now rely on all three magnetic axes (X, Y, Z) so that the Earth's field can be fully rotated back to a horizontal orientation. In Figure 31, a compass is shown with roll ( $\theta$ ) and pitch ( $\phi$ ) tilt angles referenced to the right and forward level directions of the observer or vehicle. The X, Y, and Z magnetic readings can be transformed back to the horizontal plane (XH, YH) by applying the rotational equations shown below:

$$\begin{aligned} XH &= X \cdot \cos(\phi) + Y \cdot \sin(\theta) \cdot \sin(\phi) - Z \cdot \cos(\theta) \cdot \sin(\phi) \\ YH &= Y \cdot \cos(\theta) + Z \cdot \sin(\theta) \end{aligned} \quad (5)$$

$$\text{Azimuth} = \text{arcTan} (YH / XH)$$

Once the X and Y magnetic readings are in the horizontal plane, equations (4) can be used to determine the azimuth. For speed in processing the rotational operations, a sine and cosine lookup table can be stored in program memory to minimized computation time. A block diagram for a tilt compensated compass is shown in Figure 32 with a serial bus interface. After the azimuth is determined, the declination correction can be applied to find true north according to the geographic region of operation.

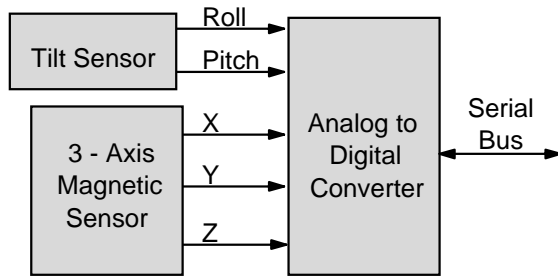

Figure 32. Tilt Compensated Compass System

## SUMMARY

Magnetic field detection has vastly expanded as industry has utilized a variety of magnetic sensors to detect the presence, strength, or direction of magnetic fields not only from the Earth, but also from permanent magnets, from magnetized soft magnets, and from the magnetic fields associated with current. These sensors are used as proximity sensors, speed and distance measuring devices, navigation compasses, and current sensors. They can measure these properties without actual contact to the medium being measured and become the eyes of many control systems. This paper has described the present state of several methods of magnetic sensing and how they are used in various applications.

### Unit conversion from SI to Gaussian:

- 79.6 A/m = 1 oersted
- 1 gauss = 1 oersted (in free air)
- 1 gauss =  $10^{-4}$  tesla =  $10^5$  gamma
- 1 nanotesla = 10 microgauss = 1 gamma

## REFERENCES

- [1] J.E. Lenz, "A Review of Magnetic Sensors", *Proceedings of the IEEE*, vol. 78, no.6, (June 1990) 973-989.
- [2] H. Yabuki, Riken-The Institute of Physical and Chemical Research, "Quasi-Planar SNS junction as a Sensor for Brain Studies".  
<[www.riken.go.jp/Yoran/BSIS/140B-141.html](http://www.riken.go.jp/Yoran/BSIS/140B-141.html)>
- [3] J.M. Janicke, *The Magnetic Measurement Handbook*, 1994, New Jersey: Magnetic Research Press.
- [4] P. Ripka, "Review of Fluxgate Sensors", *Sensors and Actuators A*, 33, (1996) 129-141.
- [5] E. Ramsden, "Measuring Magnetic Field with Fluxgate Sensors", *Sensors*, (September 1994) 87-90.
- [6] P. Ciureanu, S. Middelhoek, *Thin Film Resistive Sensors*, 1992, New York: Institute of Physics Publishing.
- [7] B.B. Pant, "Magnetoresistive Sensors", *Scientific Honeyweller*, vol. 8, no.1, (Fall 1987) 29-34.
- [8] J.E. Lenz, G.F.Rouse, L.K. Strandjord, B.B.Pant, A.Metze, H.B.French, E.T.Benser, D.R.Krahn, "A Highly Sensitive Magnetoresistive Sensors", *Solid State Sensors and Actuator Workshop*, 1992.
- [10] *Magnetic Sensors International Data Book 1995*, (Siemens Aktiengesellschaft, München, 1994).
- [11] Hall Element (data sheet), Ashai Kassi Electronics Co., Ltd., 1-1-1 Uchisaiwai-Cho, Chiyoda-Ku, Tokyo 100, Japan.
- [12] Paul Emerald, "Low Duty Cycle Operation of Hall Effect Sensors for Circuit Power Conservation," *Sensors*, vol. 15, no. 3 (March 1998), p. 38.
- [13] M. N. Baibich, J. M. Broto, A. Fert, F. Nguyen Van Dau, F. Petroff, P. Eitenne, G. Creuzet, A. Friederich, and J. Chazelas, "Giant Magnetoresistance of (001)Fe/(001)Cr Magnetic Superlattices," *Phys. Rev. Lett.*, vol. 61, 2472-2475 (1988).
- [14] Carl H. Smith and Robert W. Schneider, "Expanding The Horizons Of Magnetic Sensing: GMR," *Proceedings Sensors Expo Boston*, pp. 139-144 (Helmets, Peterborough, NH, 1997).
- [15] J. Daughton, and Y. Chen, "GMR Materials for Low Field Applications," *IEEE Trans. Magn.*, vol. 29, 2705-2710, (1993).

[16] J. Daughton, J. Brown, R. Beech, A. Pohm, and W. Kude, "Magnetic Field Sensors Using GMR Multilayer," *IEEE Trans. Magn.*, vol. 30, 4608-4610, (1994).

[17] C. Tsang, R. E. Fontana, T. Lin, D. E. Heim, V. S. Speriosa, B. A. Gurney, and M. L. Williams, "Design, fabrication and testing of spin-valve read heads for high density recording," *IEEE Trans. Mag.*, vol. 30, 3801-3806 (1994).

[18] J. K. Spong, V. S. Speriosa, R. E. Fontana, Jr., M. M. Dovek, and T. L. Hylton, "Giant Magnetoresistive Spin Valve Bridge Sensor," *IEEE Trans. Magn.*, vol. 32, 366-371 (1996).

[19] Preliminary Datasheet for Giant Magneto Resistive Position Sensor, (Siemens Aktiengesellschaft, München, 1997).

[20] J. Moodera and L. Kinder, "Ferromagnetic-insulator-ferromagnetic tunneling: Spin-dependent tunneling and large magnetoresistance in trilayer junctions," *J. Appl. Phys.* 79, No. 8, 4724-4729 (1996).

[21] "New materials show no resistance to success" Eureka Transfers Technology, January 1998, p. 26. J. L. Brown, "High Sensitivity Magnetic Field Sensor Using GMR Materials with Integrated Electronics," Proceedings of the Symposium on Circuits and Systems, Seattle, WA, January 1995

[22] "Tiny Sensor Measures Vehicles Speed," *nu-metrics News Release*, 1998.  
<[www.nu-metrics.com](http://www.nu-metrics.com)>

[23] M.J. Caruso, Set/Reset Pulse Circuits for Magnetic Sensors, *Honeywell Applications Note*, AN-201.

[24] M.J. Caruso, "Application of Magnetoresistive Sensors in Navigation Systems", *Sensors and Actuators 1997*, SAE SP-1220, (February 1997) 15-21.

[25] Olson, Gregory J., et al, "Nongimbaled Solid-State Compass", Solid-State Sensor and Actuator Workshop, June, 1994.

[26] M. Horton, C. Kitchin, "A Dual Axis Tilt Sensor Based on Micromachined Accelerometers", *Sensors*, (April 1996).