

Honeywell Precision Pressure Transducer 2



PPT2 User's Manual

Honeywell

ADS-14221 Rev. 10/16

For more information, visit us online at www.pressuresensing.com
Customer Service Email: quotes@honeywell.com

No part of this manual may be reproduced or transmitted in any form or by any means, electronic or mechanical, including photocopying and recording, for any purpose, without the express written permission of Honeywell, Inc. Honeywell reserves the right to make changes to any products or technology herein to improve reliability, function or design. Honeywell does not assume any liability arising out of the application or use of any product or circuit described herein; neither does it convey any license under its patent rights nor the rights of others.

Table of Contents

Table of Contents 3

1.0 Product Overview..... 4

2.0 Getting Started 5

3.0 PPT2 Command Summary 9

4.0 Terminology 17

5.0 Command Descriptions (alphabetical order)..... 21

6.0 Electrical Connections 75

7.0 Installation Recommendations, Cautions and Materials of Construction 77

8.0 Firmware Errata 79

Appendix A: PPT2 Binary Command Format for P3 and P4 Commands:..... 80

Appendix B: ASCII Table 83

Appendix C: Setting an Analog Pressure Set Point..... 84

Appendix D: RAM Initialization 85

1.0 Product Overview

The Honeywell Model PPT2 Precision Pressure Transducers provide high accuracy pressure readings in both digital and analog form. The first-time user will be able to use the PPT2 within minutes, yet capability exists to configure the PPT2 to optimize performance in the User's specific applications. Throughout this User's Manual, the PPT2 may be referred to as Precision Pressure Transducer.

The heart of the PPT2 measuring system is a silicon piezoresistive sensor which contains both pressure and temperature-sensitive elements. Digital signals representing temperature and pressure are processed by the PPT2 microprocessor to produce calibrated, temperature-compensated pressure readings over the entire operating temperature and pressure range.

Both the analog and digital outputs are internally corrected over the full operating range. The PPT2 has a digital accuracy of 0.075% of full scale (FS). Note that full scale for a 20 psig and a 20 psia is 20 psi, but for a 20 psid it is 40 psi, the sum of + Full scale and – Full Scale. This is important to note when determining the accuracy allowance.

The PPT2 receives commands and sends digital data using either an RS-232 serial port or a multi-drop RS-485 serial port of a computer. (Note: many newer computers will have only USB ports, no RS-232 or RS-485 ports. A USB converter can be used to provide the required RS-232 or RS-485 port.)

Using the RS-232 type PPT2, up to 89 units can be connected in a ring configuration to a single serial port of a computer. The RS-485 type PPT2 allows up to 89 PPT2's to be connected to a two-wire multi-drop bus. Group (multicast) addressing allows up to nine groups of PPT2's to be addressed with a single command. Global (broadcast) addressing will send a command to all PPT2's on the serial bus.

Any computer having a serial port and terminal emulation software can be connected to the PPT2 to allow the user to set baud rates, reading rates, reading resolution, units of pressure and other choices. (User modified functions must be set through the digital interface, using a computer with a serial port). The user-modified functions may either be used temporarily, until the PPT2 is powered down, or may be stored in the PPT2 internal EEPROM to automatically configure the PPT2 each time power is applied.

Analog output from the PPT2 16-bit digital-to-analog converter may be obtained without a host computer.

2.0 Getting Started

2.1 OVERVIEW

The first-time user should approach the PPT2 in a manner analogous to using a word processor program; i.e., many features are available but one may begin by using only those of interest at the moment.

As shipped from the factory, the default settings provide a pressure transducer that will be usable for many applications. Once the user is familiar with the performance and command structure, changes may be made and stored using the 'Store Parameters' (SP) command. Once stored, the user-defined settings are activated each time the PPT2 is powered up. This tailors the performance of the PPT2 to meet the needs of a particular application.

2.2 EQUIPMENT NEEDED

To prepare the PPT2 for operation, three items are needed:

- A mating connector with proper wiring connections (see connector part number and wiring diagrams in Section 6);
- A DC power supply;
- A source of pressure that is properly matched to the range and type of the PPT.

To operate the PPT2 in the analog output mode, one additional item is needed:

- *Voltage Output* - A five digit voltmeter with 0-5 volt range connected between Analog Out and Signal Common. A computer is not required to read the Analog output.

To operate the PPT2 in the digital output mode, one additional item is needed:

- A computer, or host processor, having an RS-232 or RS-485 serial port (or suitable USB adapter) and terminal emulation program.
The wiring diagram designates which PPT2 pins must connect to the computer "send", "receive" and "common" pins for proper communications.

2.3 TERMINAL PROGRAM SETTINGS

- Enter the following settings in the terminal program:

Baud Rate:	9600
Start Bits:	1
Data Bits:	8
Stop Bits:	1
Parity:	None

- Attach a line feed to the carriage return.
- Turn the local echo ON.

When shipped from the factory, the PPT2 is set to a baud rate of 9600, 1 start bit, 8 data bits with no parity and 1 stop bit. If the baud rate has been subsequently changed, and is unknown, it will be necessary to search all baud rate values to reestablish communication. See the BP command description in Section 5 of this manual for possible settings.

2.4 INITIAL TURN-ON RESPONSE

Analog Output

The factory default analog output will provide a voltage (range 0-5V) which, when ambient pressure is applied to the PPT2, reads:

Pressure Type	Voltage Output (@ zero applied pressure)
Gauge units	0 volt
Differential units	2.5 volts
Absolute units	A voltage representing atmospheric pressure

Digital Output

Once the wiring connections and terminal program settings are complete, the PPT2 will automatically send the following response (or similar to) when power is applied. This reply will be generated any time power to the PPT2 is cycled off and on.

Typical Reply:

?00PPT2__10__psid

The “?00” indicates a default address device called a “null address”. This PPT2 has not yet been assigned an ID number by the user, so it assumes the null address. The “PPT2__10__psid ” indicates a 10 psi differential device.

2.5 COMMAND FORMAT

Any command interaction with the PPT2 requires electrical connection to the RS-232 or RS-485 serial communications pins. There are two basic types of commands – action directing commands and information requesting commands. These are described in Commands – Section 5.

Typical PPT2 commands have the form *ddcc = nnn <cr>

Where:

* is the command header character

dd is the integer address of the PPT (00 – 89)

cc is a command (refer to Commands – Section 5 for a complete description of commands)

= equal sign (required in some commands)

nnn additional characters (required in some commands)

<cr> carriage return is required to end all commands (do not type “<cr>”, press the ENTER/RETURN key)

2.6 STEP-BY-STEP EXAMPLES (For a single PPT2 connection, default 00 address)

READ A SINGLE PRESSURE

Once the PPT2 is powered up and connected to a computer, enter the following command: (do not type "<cr>", press the ENTER/RETURN key)

User Types on the keyboard:

```
*00P1 <cr>
```

PPT2 Response:

```
?00CP=14.4582
```

Where

*	indicates the start of a command
00	is the null address of the PPT2 (see note below)
P1	is the command to read the most current pressure

Note: The "?" indicates the response from a null addressed PPT2— one which has not been assigned a device ID. A null address, 00, is coded into each PPT2 at the factory. Refer to the ID command in Section 5 for a description of addresses and responses.

The "CP=14.4582" indicates a compensated pressure of 14.4582 psi. (Your unit may not show this specific reading, depending on the applied pressure it is measuring.)

SET DEVICE ID

To give the PPT2 an assigned address of 01 up to 89, enter the following commands:

```
*00WE<cr> This enables the PPT2 to change a parameter in RAM
```

```
*00ID=01<cr> This sets the null addressed PPT2 to device ID=01.
```

Note: *The new device ID is now used in subsequent commands*

```
*01S=<cr>
```

```
Response: #01S=00052036 (serial number)
```

The "#" now replaces the "?" in the header and indicates the PPT2 response is from an address-assigned unit.

READ PRODUCTION DATE

To read the production date, enter the following command:

```
*01P=<cr>
```

```
Response: #01P=04/13/11
```

READ CONTINUOUS PRESSURE

For continuous pressure readings (factory default rate = 5 per second) enter the following command:

- *01P2<cr> This enables a continuous stream of compensated pressure readings to flow into the terminal program.
- \$*99IN<cr> This is the best way to stop the continuous pressure reading commands. The '\$' character temporarily stops, or suspends, the digital output of the PPT2. The *99IN command stops the continuous pressure or temperature readings.

CHANGE TO A NEW READING RATE

Enter the following command:

- *01WE <cr> This enables the PPT2 RAM to accept a changed parameter.
- *01I=M200<cr> This sets the integration time to value M200, which corresponds to an output reading every 2 seconds.

The reading rate will change to one every 2 seconds. I= is an abbreviation for Integration time, which determines how long to accumulate corrected pressure values between readings. Each integration period gathers the data for one pressure reading output (see Section 4.2 What is integration?). The range of integration times can be set by specifying readings per second (I=R50 for 50 readings/sec) or in 10 millisecond intervals (I=M600 for 6 seconds). The factory-set integration time is 200 milliseconds or 5 readings per second (I=M20).

The output data rate can also be altered by use of the idle count (IC) command or by changing the operating mode (OP) command. See Section 5 for description of these commands.

REPEAT THE READ CONTINUOUS PRESSURE STEP ABOVE

Notice the slower output rate of one reading every 2 seconds.

TRY OTHER COMMANDS

Experiment with other commands to become familiar with the command structures. A short overview of each command with input and response examples is shown in Section 3 Command Summary. See Section 5—Commands for complete command descriptions. Until an SP=ALL command is executed, no changes will be stored in the PPT2 EEPROM. Re-apply the power or send an IN=RESET command to revert to the settings last saved in EEPROM.

3.0 PPT2 Command Summary

The PPT2 command set is summarized in Table 1.0 – Command List. A more detailed description of each command can be found in the subsequent command descriptions in Section 5.

Table heading explanations for Table 1.0 – Command List:

<u>Command Code:</u>	Two-character code (cc) in the command format (see Section 2.5). The command code characters may be one letter followed by an '=' equal sign, two letters, or a letter and a number. The letters are not case sensitive; i.e. either upper case or lower case may be used. (The PPT2 internally converts all lower case characters to upper case.)
<u>Action Directing Command:</u>	Does this command change the PPT2 configuration? Yes – The command changes the PPT2 configuration as an action directing command. No – The command is <u>only</u> an Information Request Command.
<u>Information Request Command:</u>	The command initiates a response (output) from the PPT2, with the output content being specific to that particular PPT2.
<u>Sequential Response with Group or Global Address:</u>	Commands that begin with a group or global address (ID=90-99), are passed through the PPT2 ring configuration network from one device to the next and eventually end up back at the host computer. The PPT2 response is sent with the command through the network. Before – The PPT2 response is sent <u>before</u> the group or global command is repeated. After – The PPT2 response is sent <u>after</u> the group or global command is repeated. No – The PPT2 just passes the command through the network with <u>no</u> response.
<u>Input or Output:</u>	Is information input to the PPT2 or output from the PPT2? In – Command is only used to input (action direct command) to the PPT2. Out – Command is only used to request output (Information Request Command) from the PPT2. Both – Command can be used for either IN or OUT purposes.
<u>Requires Write Enable:</u>	Is a WE command required before for this command? Yes – When sent as an action directed command, it must be preceded by a WE command. No – Never requires a WE command beforehand. These are Information Request Commands.
<u>Terminates Continuous Commands:</u>	Will this command stop the PPT2 digital output flow? Yes – This command will end the continuous flow of the P2, P4, or T2 replies. No – Command will not stop the continuous digital output flow.

Write to EEPROM:

Can this command have parameters stored in EEPROM?

Yes – Parameter values associated with this command may be stored in EEPROM.

No – Cannot store anything from this command in EEPROM.

All – Cause all parameters to be stored in EEPROM.

Write to DAC:

Can this command be written to the DAC?

Yes – Command may be directed to the DAC.

No – Command is not associated with the DAC.

Table 1.0 – Command List, Grouped by Function
 See previous page for descriptions of the table headings.

Command Code	Action Directing Command	Sequence of Response with (90-99) Addresses	Input or Output Type	Requires Write Enable	Terminates Continuous Commands	Can Write to EEPROM?	Can Write to DAC?	Command Description
--------------	--------------------------	---	----------------------	-----------------------	--------------------------------	----------------------	-------------------	---------------------

Pressure Readings

P1	No	Before (5)	Out	No	No	No	No	Pressure, Single, ASCII Format
P2	No (3)	After	Out	No	Yes (8)	No	No	Pressure, Continuous, ASCII Format
P3	No	Before (5)	Out	No	No	No	No	Pressure, Single, Binary Format
P4	No (3)	After	Out	No	Yes (8)	No	No	Pressure, Continuous, Binary Format

Pressure Units

DU	Yes	Before	Both	Yes (6)	No	Yes (9)	No	Display Units Control
U=	Yes	After (4)	Both	Yes (6)	No	Yes (9)	No	User Supplied Display Units

Pressure Sensor Temperature Readings

T1	No	Before (5)	Out	No	No	No	No	Sensor Temperature, Single, °C
T2	No (3)	After	Out	No	Yes (8)	No	No	Sensor Temperature, Continuous, °C

Transducer Information

ID	Yes	Before	Both	Yes (6)	No	Yes (9)	No	Identification Number
M=	Yes	After (4)	Out	No	No	No	No	Maximum Full Scale Pressure
P=	No	After (4)	Out	No	No	No	No	Production Date
S=	No	After (4)	Out	No	No	No	No	PPT2 serial number
V=	No	After (4)	Out	No	No	No	No	PPT2 Firmware Version

Pressure Reading Modifiers

IE	Yes	After (4)	Both	Yes (6)	No	Yes (9)	No	Integration Time
IC	Yes	Before	Both	Yes (6)	No	Yes (9)	No	Idle Count Parameter
CM	Yes	Before	Both	Yes (6)	No	Yes (9)	No	Compatibility Mode (new command)
DS	Yes	Before	Both	Yes (6)	No	Yes (9)	No	Deadband and Sensitivity Control

Pressure Window Customization, Calibration, and Control

F=	Yes	After (4)	Both	Yes (6)	No	Yes (9)	No	Customized Full Scale Pressure Range
T=	Yes	After (4)	Both	Yes (6)	No	Yes (9)	No	Set Tare Value
TC	Yes	Before	Both	Yes (6)	No	Yes (9)	No	Tare Control Switch
X=	Yes	After (4)	Both	Yes (6)	No	Yes (9)	No	Slope 1, User Compensation Control
Y=	Yes	After (4)	Both	Yes (6)	No	Yes (9)	No	Slope 2, User Compensation Control
Z=	Yes	After (4)	Both	Yes (6)	No	Yes (9)	No	Offset, User Compensation Control

Analog Customization, Calibration, and Control

AN	Yes	Before	Both	Yes (6)	No	Yes (9)	No	Analog Range Setting
DX	Yes	After (4)	Both	Yes (6)	No	Yes (9)	No	DAC Slope Compensation Control (new command)
DZ	Yes	After (4)	Both	Yes (6)	No	Yes (9)	No	DAC Offset Compensation Control (new command)
H=	Yes	After (4)	Both	Yes (6)	No	Yes (9)	Yes (11)	Highest Analog Voltage

<u>L=</u>	Yes	After (4)	Both	Yes (6)	No	Yes (9)	Yes (11)	Lowest Analog Voltage
<u>O=</u>	Yes	After (4)	Both	Yes (6)	No	Yes (9)	Yes (11)	Offset Pressure Window (analog output)
<u>W=</u>	Yes	After (4)	Both	Yes (6)	No	Yes (9)	Yes (11)	Width of Analog Window
<u>N=</u>	No (3)	After (4)	Both	No (7)	No	No	Yes (11)	Send Number to DAC (force analog output)

Diagnostic and Reset Control

<u>CK</u>	No	After (4)	Out	No	No	No	No	Check Memory
<u>IN</u>	No (2)	No	In	No	Yes	No	No	Initialize PPT2 Microprocessor
<u>RS</u>	No	Before (5)	Out	No	No	No	No	Read Status

Operating Parameters

<u>BP</u>	Yes	After (4)	In	Yes	Yes	Yes (9)	No	Baud Rate and Parity Setting
<u>DA</u>	Yes	Before	Both	Yes (6)	No (12)	Yes (9)	Yes (10)	Digital and Analog Control
<u>DO</u>	Yes	Before	Both	Yes (6)	No	Yes (9)	No	Default Operating Parameters
<u>MO</u>	Yes	Before	Both	Yes (6)	No	Yes (9)	No	Power-up Mode
<u>OP</u>	Yes	Before	Both	Yes (6)	No	Yes (9)	No	Operating Mode Parameters
<u>TO</u>	Yes	Before	Both	Yes (6)	No	Yes (9)	No	Transceiver Operating Parameters

Utility

<u>A=</u>	No	After (4)	Both	Yes	No	Yes (9)	No	Data string A
<u>B=</u>	No	After (4)	Both	Yes	No	Yes (9)	No	Data string B
<u>C=</u>	No (1)	After (4)	Both	Yes				
<u>D=</u>	No (1)	After (4)	Both	Yes	No	Yes (9)	No	Data string D
<u>FD</u>	Yes	No	In	Yes	No	No	No	Restore Factory Defaults (new command)
<u>NE</u>	No	No	In	No	No	Yes (9)	Yes	Analog Output Enable
<u>SP</u>	Yes	No	In	Yes	No	All	No	Store RAM parameters in EEPROM
<u>WE</u>	Yes	No	In	No	No	No	No	Write enable for RAM/EEPROM
<u>§</u>								Suspend Continuous Readings

COMMAND LIST NOTES

- (1) The **C=** and **D=** commands do not change the mode of operation but do provide a user supplied power-up message if configured using the **MO** command.
- (2) The **IN** command does not change the operating parameters stored in RAM, but it does stop continuous readings (**P2, P4, T2** commands). If the **IN=RESET** command is sent, then any parameters that were stored in RAM, and were not stored in the EEPROM with a **SP** command, will default to the last stored EEPROM value. This may cause a change in the operational parameters as well as a configuration change.
- (3) The **P2, P4,** and **T2** commands do not change the operating parameters, only activate continuous readings. The **N=** command does not change any operating parameter values only the DAC analog output voltage.
- (4) When this information request command is sent to a group or global address, the PPT2s do not immediately respond with their output. The command is repeated from PPT2 to PPT2 in a ring configuration network, and eventually returned to the host processor. Each PPT2 appends its own response as it forwards the command. Also, this command requires more time for execution, of EEPROM reads, so responses from more than one PPT2 are not received in any guaranteed order. During the execution of one of this command, if another command is received that is an "After" type, whether globally, group, or individually addressed, the received command is rejected and the command read status error (see **RS** command) is set.
- (5) These commands may cause sequential responses from any, all or none of the addressed units. A sequential response is when the PPT2 reply is sent before the global or group command through the network. See the individual command descriptions for detailed information.
- (6) These commands only require a write enable (**WE**) when used in the action directing form. For these commands the **WE** command provides a single occurrence write enable for RAM update. That is, only the next instruction is written to RAM. The **WE=RAM** command provides continuous write enables for RAM for multiple command updates. The continuous RAM enable is active until a **WE** is sent.
- (7) The **N=** command requires an **NE** command enable when used to send information. The **NE** command provides single occurrence write enable for analog control. The **NE=DAC** command can be used to provide continuous write enable for analog control.
- (8) These commands terminate an active continuous reading command (**P2, P4, T2**) and initiate the new one.
- (9) These commands can be used to change RAM contents which can then be written to the EEPROM using the **SP=ALL** command.
- (10) The **DA** command does not write to the DAC but it does allow the DAC to be controlled by the PPT2 input pressure value or by a digital value applied by the **N=** command.
- (11) These commands only write to the DAC when used in the action directing form.
- (12) A P2 mode will be cancelled when a DA= A, C, F, G or N parameter is selected. A P4 mode can be cancelled when a DA=A, E, M or N parameter is selected.

COMMAND FORMAT

Communication between the host or control processor and a PPT2 is accomplished by message transfers, or commands and replies. Communications initiated by the host processor to one or more PPT2s are called commands and must begin with an '*' header character. (For RS-485 PPT2s, alternate header characters are available, using the **MO** command.) All commands must be terminated by a <cr> (carriage return or ENTER key). Communications initiated by a PPT2 to the host are called responses or replies, and begin with one of ten unique header characters (2 for ASCII responses, 8 for binary format responses).

Commands may request information from one or more PPT2s such as read pressure, or direct action to one or more PPT2s such as change a command value or operating mode.

Typical PPT2 command format: ***ddcc = nnn <cr>**

Where:	*	is the command header character
	dd	is the decimal address of the command message (00-99)
	cc	is the command code. Command code characters sent to the PPT2 are not case sensitive; i.e., either an upper case or lower case may be used. Responses from the PPT2 will have capitalized command code characters. Example: #01CP=14.2426
	=	equal sign (required in some commands)
	nnn	additional characters (required in some commands)
	<cr>	carriage return (the ENTER key on a standard keyboard)

Note: For RS-485 mode, alternate headers are available. (see **MO** command)

In an RS-232 network, when manually applying commands to one or more PPT2s which are in the continuous send mode (**P2**, **P4**, **T2**,), the special header character '\$' should be used to suspend all PPT2 transmissions while the command message is being typed. The '\$' is immediately followed by the normal command format.

In the case of an RS-232 network, if an erroneous command is sent to the PPT2, it is echoed back to the host as soon as the PPT2 recognizes it as an invalid command. For example, if the user tries to enter *01S2=15 (S2 is not a valid command for the PPT2), *01S2 would immediately be echoed back. The other instance of an echoed command is when a group or global address command (ID = 90 to 99) is sent, such as *99I=R15<cr>. Group/global addresses will always echo the command back to the host processor after being read by all PPT2s in the network.

PRESSURE READING DECIMAL POSITION

The table below shows the number of decimal place variations with respect to PPT2 full scale - the number of digits to the right and left of the decimal place. This is valuable when converting a binary format number so that the proper decimal position can be determined.

If CM=ON (PPT Compatibility Mode), subtract 1 from the "Digits to Right" column of the table below.

Full Scale * (current Display Units)	Digits to Left	Digits to Right	Digit to Left if -1 < reading < 1	Negative Values
≥ 9,000,000	8	1	0, padded w/ leading spaces	"-" inserted after "="
≥ 900,000 and < 9,000,000	7	1	0, padded w/ leading spaces	"-" inserted after "="
≥ 90,000 and < 900,000	6	1	0, padded w/ leading spaces	"-" inserted after "="
≥ 9,000 and < 90,000	5	1	0, padded w/ leading spaces	"-" inserted after "="
≥ 900 and < 9000	4	2	0, padded w/ leading spaces	"-" inserted after "="
≥ 90 and < 900	3	3	0, padded w/ leading spaces	"-" inserted after "="
≥ 9 and < 90	2	4	0, padded w/ leading space	"-" inserted after "="
≥ 0.9 and < 9	1	5	0	"-" inserted after "="
≥ 0.09 and < 0.9	1	6	0 or "-"	Leading zero replaced with "-"
≥ 0.009 and < 0.09	1	7	0 or "-"	Leading zero replaced with "-"
≥ 0.0009 and < 0.009	1	8	0 or "-"	Leading zero replaced with "-"
< 0.0009	1	9	0 or "-"	Leading zero replaced with "-"

* For differential units, when determining decimal point position the Full Scale is the maximum positive pressure (5 psid = 5, 20 psid = 20, etc)

Whether OP=E (extended) or OP=F (fixed) also has an impact upon how the data is displayed.

Example readings:

5 psid, OP=E, F=0 (5 psi)

```
?00CP=-0.00141      (negative reading > -1)
?00CP=0.02373       (positive reading < 1)
?00CP=-3.00537      (negative reading < -1)
?00CP=2.36973       (positive reading > 1)
```

5 psid, OP=F, F=0 (5 psi)

```
?00CP=-0.01442      (negative reading < -1)
?00CP= 0.00454       (positive reading < 1)
?00CP=-4.37939      (negative reading < -1)
?00CP= 3.80066       (positive reading > 1)
```

5 psid, OP=E, F=0.8 psi

```
?00CP=-.551017      (negative reading)
?00CP=0.804965      (positive reading)
```

5 psid, OP=F, F=0.8 psi

```
?00CP=-.779264      (negative reading)
?00CP=0.733452      (positive reading)
```

PPT Commands/Parameters Not Implemented in PPT2

DA={O S T U}	Digital and Analog Control
DO=N P	Noise Protection in P4 mode
NE=ZER[O,V]	NE Command Extension
RR	Reading Rate
S2	Speed Shift x2
S5	Speed Shift at 50msec Intervals
SI	Synchronize Integration Cycles
T3	Temperature, Single, °F
T4	Temperature, Continuous, °F
TO=R M	Special Ring and Multi-drop protocol functionality
TO=C A S H	Synchronization functionality
TO=N P	Normal and Prompted RS-485 group/global read operations
~	Command Header for Binary DAC Values

4.0 Terminology

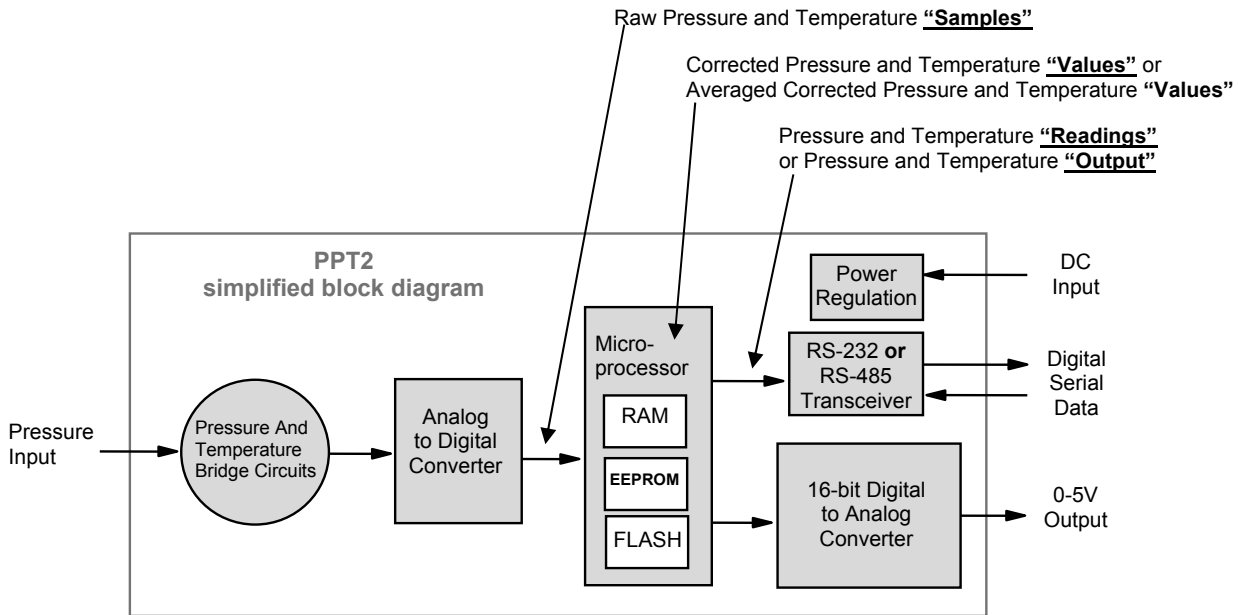

4.1 WHAT IS INTEGRATION?

The input pressure is converted to an analog electrical signal at the pressure sensor. This signal feeds into a delta-sigma analog-to-digital (A/D) converter where it is changed into a digital signal representing the pressure value. During the A/D conversion cycle, the signal is integrated over time. That is, the pressure reading is averaged (integrated) over the A/D conversion cycle so the resultant digital value is the summation of the average pressures observed during the cycle. This conversion cycle is controlled by the user with the Deadband and Sensitivity (DS), Idle Count (IC), and Integration (I=) commands.

4.2 PRESSURE READING CONTROL

The PPT2 commands allow considerable flexibility in tailoring pressure acquisition times, reading windows, thresholds, and output rates. These are controlled by 4 commands: Deadband and Sensitivity (DS), Integration (I=), Idle Count (IC), and OPerating mode (OP). The user may control these attributes in three ways:

First, the internal integration time may be controlled over a range of 1 reading every 10 seconds up to 1000 readings per second. This is controlled using the 'Integration' (I=) command. Pressure values are calculated every millisecond. The integration time is used to control the amount of averaging of these pressure values to create each pressure value. The integration time can be set within a range of 1 to 1000 readings/sec using the **I=Rn** form, or a range of 10 msec to 10 sec/reading using the **I=Mn** form. The values for 'n' range from 1 to 1000 for both the rate (Rn) form and the millisecond (Mn) form.

Second, the integration cycles may be spaced with idle periods that cause pressure reading times to increase to as long as one every 42.67 minutes. The Idle Count (IC) command will insert, or skip, from 0 to 255 idle periods equal to the integration time. If the integration time is set to the maximum, 10 sec/reading, and an idle count of 255 is selected, then the time between readings = 10 sec. x 256 = 42 minutes, 40 seconds.

Third, the reading rate may be controlled so pressure readings are obtained only when pressure changes occur. The OPerating mode command (OP) can be set to output every reading (OP=A) or to only output changes (OP=U). The Deadband setting in the DS command can filter a small pressure change by not allowing the pressure output reading to vary as long as it remains within the

deadband limits. This controls the **OP** command mode's sensitivity to pressure change when the 'output only when pressure changes' (**OP=U**) option is selected.

4.3 PPT2 ADDRESSING

The PPT2 provides three levels of addressing. The lowest level of address is the individual unit address, or **device ID**. This address level is used to address any single PPT2. The next level is **group address**, which is separate from the device ID. All PPT2 units with the same group address will respond to a command sent to this level address. The last is a **global address**, which is read by all PPT2s on a network. The device ID can be assigned by direct command or assigned automatically based on its position from the host processor in PPT2 network. The **null address** (00) is simply a default device ID that the PPT2 automatically assumes until one is assigned. That is, upon power-up, if there is no ID assigned, and an ID has not been stored in the EEPROM, then the PPT2 will assign itself the "00" null address.

The individual unit address, or **device ID**, has an assigned range from 01-89. The null address 00 is the factory default address for unassigned PPT2s. A unit with the null address, replies with a 'null address' header. The null address header characters are '?' for ASCII format (standard keyboard alphanumeric characters) or '^, &, |, or %' for binary format (fewer data bytes that are encoded for computer translation.) A unique device ID allows the host processor to send commands to specific units on a bus.

The second level of addressing is a multicast, or **group**, address in the range of 90-98. Each unit can be assigned a group address by the ID command. A unit responds to its group address in the same manner as it does to its global address described below. The group addressing allows the host processor to send commands to several units having the same group address. The factory default group address is 90.

The highest level of addressing is the broadcast, or **global**, address 99. All units receive global addressed commands. All RS-232 units respond to global commands. Only RS-485 units with assigned addresses will respond to global commands. An RS-485 unit with a null address will not reply to any global command. Global addresses are not assigned but are built into the PPT2.

RS-232 Ring Network

The RS-232 network consists of a three-wire bus (TD, RD, and GD) that begins and ends at the host processor. In general, the RS-232 electrical standard requires that the distance *between* units not exceed 60 feet (18 meters). An advantage of the RS-232 network is that it interfaces directly to the serial COM port of most personal computers (or USB to serial adaptor). The maximum number of PPT2s with assigned device IDs on a network is 89.

A PPT2 ring network connection of six units is shown below. In this example, the Device IDs are sequential, starting from 01, from the transmit port of the host processor around the loop. There are two address groups, 91 and 93; each have 3 PPT2 units assigned.

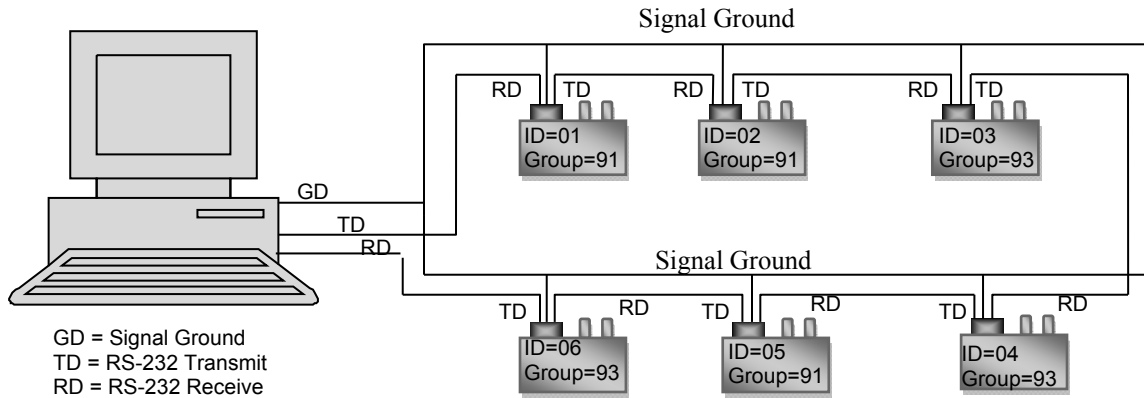

Each PPT2 on a communication ring must have a unique address in order to *individually* receive commands from the host processor. For example, if more than one PPT2 on a ring has a null address, and a 00 address command is transmitted by the host, only the first null address PPT2 will receive the command and the command is not passed on. This is the same for any address on an RS-232 ring network.

Another advantage of the RS-232 ring network is the ability to automatically assign device IDs to every PPT2 on the network. Since commands flow through every PPT2 on the ring, a single ***99ID=01** command will assign ID=01 to the first unit, and each in the ring will assign itself the next number. As the command is passed along, each unit adds one to the ID command. For the example network shown above, the command will read ***99ID=07** when it returns to the host processor. The form of self-addressing will indicate the PPT2 position in the communication ring relative to the host processor.

Every unit in the RS-232 ring network has an assigned group address. When the host processor sends a group addressed (***90 to *98**) command, that command cycles through every PPT2 and is passed to the next one in the loop. Those units having that group address read the command, then pass the command and reply to the next unit in the ring. Some responses pass the string of PPT2 replies before the group command while others pass the string of PPT2 replies after the group command. See Table 1.0 for specific command types and the order of repeating the group command.

Every unit in the RS-232 ring network receives a global addressed (***99**) command. All units read the command and pass the command and their response to the next unit in the ring.

RS-485 Multi-drop Network

The RS-485 network consists of a two-wire bus (A and B) that begins at the host processor and ends at the far end from the processor. A star network configuration can also be used where each unit is connected directly to the A and B terminals at the host processor. An advantage of the RS-485 network is that it can extend up to 4,000 feet (1,220 meters) and units can be added and removed without breaking the network connection. The maximum number of addressable PPT2's on a network is 89.

A PPT2 multi-drop network connection of six units is shown below. In this network, the device IDs are not in order from one end of the network to the other. Looking at all the units on the bus, the device IDs are sequential beginning with ID=01 and without duplication. This is an important setup condition if global command operation (*99) is desired.

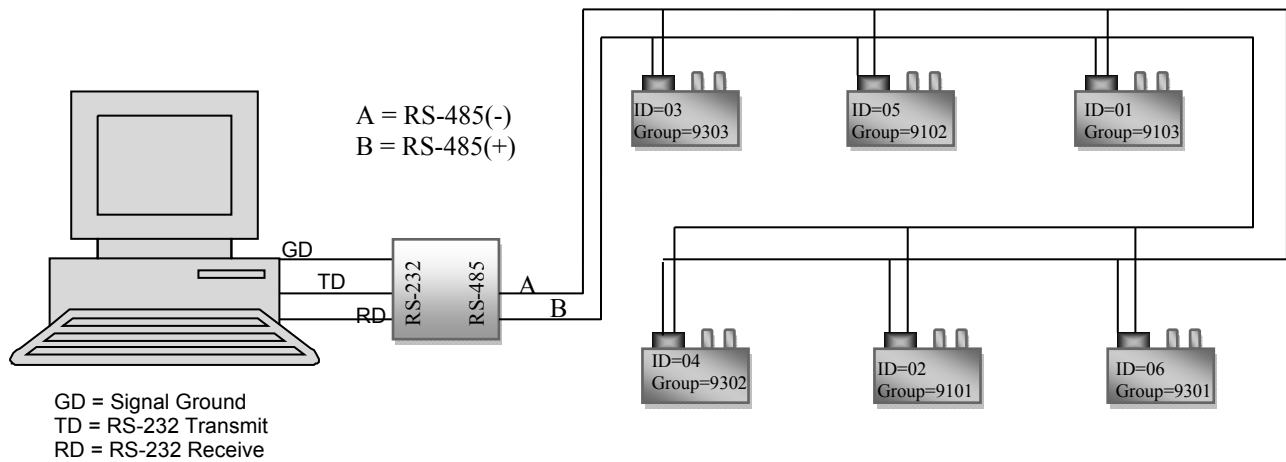

5.0 Command Descriptions (alphabetical order)

COMMAND CODE		COMMAND DESCRIPTION												
A=		Data String A												
Action Directing	Sequential Response with (90-99) address	Input or Output Type	Requires Write Enable	Terminates Continuous Commands	Can Write to EEPROM	Can Write to DAC								
No	After (4)	Both	Yes	No	Yes (9)	No								
<p>DETAILS: The A= data string command can be used to store and retrieve up to eight characters in the EEPROM. This command must have 1 to 8 characters immediately following the '=' character. The message is terminated with the <cr> (ENTER key) character. If this string is stored in EEPROM with the SP=ALL command, it will remain in the PPT2 even after the power is turned off. Example uses include dates for maintenance checks, over/under range pressure or temperature values, or key pressure readings specific to application. (Default: A=<empty>)</p>														
NOTE:														
<p>EXAMPLES:</p> <p>Inquiry: *ddA=</p> <table style="width: 100%; border: none;"> <tr> <td style="width: 30%;">Action:</td> <td style="width: 30%;">*ddWE</td> <td style="width: 30%;">EEPROM Store:</td> <td style="width: 10%;">*ddWE</td> </tr> <tr> <td></td> <td>*ddA=Your_msg</td> <td></td> <td>*ddSP=ALL</td> </tr> </table> <p><i>Your_msg</i> must have 1 to 8 characters immediately following the '=' character. The message is terminated with the <cr> character. The legal characters for <i>Your_msg</i> include all characters between the 'space' (SP) and lower case 'z' inclusive, except the '*', in standard ASCII. Other characters outside this range are replaced with the "space" character. (see Appendix B for the ASCII table)</p>							Action:	*dd WE	EEPROM Store:	*dd WE		*dd A=Your_msg		*dd SP=ALL
Action:	*dd WE	EEPROM Store:	*dd WE											
	*dd A=Your_msg		*dd SP=ALL											
<p>DIFFERENCES FROM LEGACY PPT: The A= command will now work with a *ddWE=RAM continuous write enable is active. The SP=ALL command is now required before the value is written to EEPROM. The PPT stored a parity bit for each pair of ASCII characters stored in the 8 character A= register. This is not required for the PPT2. The PPT response is always 8 characters with trailing spaces if required. The PPT2 responds only with the characters stored.</p>														

COMMAND CODE		COMMAND DESCRIPTION				
B=		Data String B				
Action Directing	Sequential Response with (90-99) address	Input or Output Type	Requires Write Enable	Terminates Continuous Commands	Can Write to EEPROM	Can Write to DAC
No	After (4)	Both	Yes	No	Yes (9)	No
<p>DETAILS: The B= data string command can be used to store and retrieve up to eight characters in the EEPROM. This command must have 1 to 8 characters immediately following the '=' character. The message is terminated with the <cr> (ENTER key) character. If this string is stored in EEPROM with the SP=ALL command,, it will remain in the PPT2 even after the power is turned off. Example uses include dates for maintenance checks, over/under range pressure or temperature values, or key pressure readings specific to application. (Default: B=<empty>)</p>						
NOTE:						
<p>EXAMPLES: Inquiry: *ddB=</p> <p style="padding-left: 40px;"> Action: *ddWE EEPROM Store: *ddWE *ddB=Your_msg *ddSP=ALL </p> <p style="padding-left: 80px;"> <i>Your_msg</i> must have 1 to 8 characters immediately following the '=' character. The message is terminated with the <cr> character. The legal characters for <i>Your_msg</i> include all characters between the 'space' (SP) and lower case 'z' inclusive, except the '*', in standard ASCII. Other characters outside this range are replaced with the "space" character. (see Appendix B for the ASCII table) </p>						
<p>DIFFERENCES FROM LEGACY PPT: The B= command will work with a *ddWE=RAM continuous write enable is active. The SP=ALL command is now required before the value is written to EEPROM. The PPT also implemented parity with the B= contents. This will not be required for the PPT2. The PPT response is always 8 characters with trailing spaces if required. The PPT2 responds only with the characters stored.</p>						

COMMAND CODE		COMMAND DESCRIPTION				
BP		Baud Rate and Parity Setting				
Action Directing	Sequential Response with (90-99) address	Input or Output Type	Requires Write Enable	Terminates Continuous Commands	Can Write to EEPROM	Can Write to DAC
Yes	After (4)	In	Yes	Yes	Yes (9)	No
<p>DETAILS: The Baud rate and Parity command is used to change the baud rate and parity type. Both the write enable (WE) and BP command must be sent as a global address (e.g. *99); otherwise, the command is rejected and a read status (RS) command error bit is set.</p> <p>For this command, only the first two baud rate characters, that uniquely identify the baud rate, need to be used. Values beyond the first two valid baud rate characters will be ignored. Example: *99BP=N48X1 will cause the baud rate to be set to 4800. If the first two baud rate characters are invalid, the command will be rejected and the command error flag set in the RS command response.</p> <p>For networked RS-232 devices, this command causes the new baud rate and parity setting to be changed and the command to be retransmitted to the next PPT2. For multi-drop networked RS-485 devices all units receive the command at the same time. When the command transmission is complete, the new baud rate and parity are activated, but are not permanently stored in the EEPROM until an SP=All command is executed. A corresponding new communication port baud rate <i>must</i> be selected before executing the SP=ALL command. (Default BP=N9600)</p>						
<p>NOTE: As shipped, the PPT2 is set to a baud rate of 9600, 1 start bit, 8 data bits, no parity, and 1 stop bit. If the baud rate has been changed to an unknown value, it will be necessary to search all the baud rate values to reestablish communication. When setting the baud rate, all continuous transmission commands (P2, P4 and T4) will be terminated.</p>						
<p>EXAMPLES:</p> <p>Inquiry: *ddBP EEPROM Store: *99WE *99SP=ALL</p> <p>Response: #ddBP=N <i>or</i> #ddBP=E <i>or</i> #ddBP=O</p> <p>Note: Both a *99WE and *99BP=. global address <i>must</i> be used to change the baud rate.</p> <p>Action: *99WE *99BP= {N E O} {1200 2400 4800 9600 14400 19200 28800 38400 57600 115200}</p> <p>N No parity E Even parity O Odd parity</p> <p>1200,...115,200 Baud rate (bits/sec)</p>						
<p>DIFFERENCES FROM LEGACY PPT: The PPT2 adds three new baud rates: 38400, 57600, and 115200.</p>						

COMMAND CODE		COMMAND DESCRIPTION								
C=		Data String C								
Action Directing	Sequential Response with (90-99) address	Input or Output Type	Requires Write Enable	Terminates Continuous Commands	Can Write to EEPROM	Can Write to DAC				
No (1)	After (4)	Both	Yes	No	Yes (9)	No				
DETAILS: The C= data string command can be used to store and retrieve up to eight characters in the EEPROM. This command must have 1 to 8 characters immediately following the '=' character. The message is terminated with the <cr> (ENTER key) character. If this string is stored in EEPROM using the SP=ALL command, it will remain in the PPT2 even after the power is turned off. Example uses include dates for maintenance checks, over/under range pressure or temperature values, or key pressure readings specific to application. (Default: C=<empty>)										
NOTE: When MO=M2 or M3, the contents of the C= data string are used as the first 8 characters of the user startup message.										
EXAMPLES: Inquiry: *dd C= <table style="width: 100%; border: none;"> <tr> <td style="width: 50%;">Action: *ddWE</td> <td style="width: 50%;">EEPROM Store: *ddWE</td> </tr> <tr> <td style="padding-left: 40px;">*ddC=<i>Your_msg</i></td> <td style="padding-left: 40px;">*ddSP=ALL</td> </tr> </table> <i>Your_msg</i> must have 1 to 8 characters immediately following the '=' character. The message is terminated with the <cr> character. The legal characters for <i>Your_msg</i> include all characters between the 'space' (SP) and lower case 'z' inclusive, except the '*', in standard ASCII. Other characters outside this range are replaced with the "space" character. (see Appendix B for the ASCII table)							Action: *dd WE	EEPROM Store: *dd WE	*ddC= <i>Your_msg</i>	*dd SP=ALL
Action: *dd WE	EEPROM Store: *dd WE									
*ddC= <i>Your_msg</i>	*dd SP=ALL									
DIFFERENCES FROM LEGACY PPT: The C= command will work with a *ddWE=RAM continuous write enable is active. The SP=ALL command is now required before the value is written to EEPROM. The PPT also implemented parity with the C= contents. This will not be required for the PPT2. The PPT response is always 8 characters with trailing spaces if required. The PPT2 responds only with the characters stored.										

COMMAND CODE		COMMAND DESCRIPTION				
CK		Check Memory				
Action Directing	Sequential Response with (90-99) address	Input or Output Type	Requires Write Enable	Terminates Continuous Commands	Can Write to EEPROM	Can Write to DAC
No	After (4)	Out	No	No	No	No
<p>DETAILS: The CheckK Memory command performs a checksum calculation on both the characterization area and the configuration area of memory. This check typically takes approximately 240 msec.</p>						
<p>NOTE: This command is automatically executed at power-up on all factory-default PPT2 units. (On power up, there is no automatic CK= response from the PPT2.) The MO command can be used to turn off this function at power-up. When memory errors are detected, integration cycles are immediately halted and associated bits in the RS command response are set. See RS command description for details.</p>						
<p>EXAMPLES:</p> <p>Inquiry: *ddCK</p> <p style="padding-left: 40px;">There are eight possible responses for this command.</p> <p>#(or ?)ddCK=OK No checksum errors #(or ?)ddCK=ERR1 Configuration memory checksum error #(or ?)ddCK=ERR2 Pressure correction data checksum error #(or ?)ddCK=ERR3 DAC correction data checksum error #(or ?)ddCK=ERR4 Configuration memory and DAC correction data checksum error #(or ?)ddCK=ERR5 Configuration memory and pressure correction data checksum error #(or ?)ddCK=ERR6 Both pressure and DAC correction data checksum errors #(or ?)ddCK=ERR7 Checksum errors in all three regions of memory</p>						
<p>DIFFERENCES FROM LEGACY PPT: The PPT command was titled "Check EEPROM." It only checked the contents of the off-chip EEPROM memory. The error responses, ERR1 – ERR5 are slightly different than the PPT implementation. The checksum used in the <u>PPT</u> firmware is an 8-bit Fletcher Checksum. The <u>PPT2</u> uses (2) 16-bit checksums for EEPROM memory, and (2) 24-bit checksums for pressure and DAC correction coefficients.</p>						

COMMAND CODE		COMMAND DESCRIPTION				
D=		Data String D				
Action Directing	Sequential Response with (90-99) address	Input or Output Type	Requires Write Enable	Terminates Continuous Commands	Can Write to EEPROM	Can Write to DAC
No (1)	After (4)	Both	Yes	No	Yes (9)	No
DETAILS: The D= data string command can be used to store and retrieve up to eight characters in the EEPROM. This command must have 1 to 8 characters immediately following the '=' character. The message is terminated with the <cr> (ENTER key) character. If this string is stored in EEPROM using the SP=ALL command, it will remain in the PPT2 even after the power is turned off. Example uses include dates for maintenance checks, over/under range pressure or temperature values, or key pressure readings specific to application. (Default: D=<empty>)						
NOTE: When MO=M2 or M3, the contents of the D= data string are used as the last 8 characters of the user startup message.						
EXAMPLES: Inquiry: *ddD= Action: *ddWE *ddD=Your_msg EEPROM Store: *ddWE *ddSP=ALL <i>Your_msg</i> must have 1 to 8 characters immediately following the '=' character. The message is terminated with the <cr> character. The legal characters for <i>Your_msg</i> include all characters between the 'space' (SP) and lower case 'z' inclusive, except the '*', in standard ASCII. Other characters outside this range are replaced with the "space" character. (see Appendix B for the ASCII table)						
DIFFERENCES FROM LEGACY PPT: The D= command will work with a *ddWE=RAM continuous write enable is active. The SP=ALL command is now required before the value is written to EEPROM. The PPT also implemented parity with the D= contents. This will not be required for the PPT2. The PPT response is always 8 characters with trailing spaces if required. The PPT2 responds only with the characters stored.						

COMMAND CODE		COMMAND DESCRIPTION				
DA		Digital and Analog Control				
Action Directing	Sequential Response with (90-99) address	Input or Output Type	Requires Write Enable	Terminates Continuous Commands	Can Write to EEPROM	Can Write to DAC
Yes	Before	Both	Yes (6)	No (12)	Yes (9)	Yes (10)

DETAILS:
 The **D**igital and **A**nalog control command determines which signals connect to the digital output and which to the analog DAC output. The analog output can be disabled (**C, D, M**), set to track the input pressure (**A, B, E, F**), or can be set to the N= value (**G, N, R**). When the analog output is not changing, the voltage output remains at its last setting. When tracking pressure, the digital output can be set to binary format or ASCII format. When using the **P1** or **P2** commands, the digital output can be disabled (**A, C, F, G, N**), or set to track the pressure input using the ASCII format (**B, D, E, M, R**). When using the **P3** or **P4** commands, the digital output can be disabled (**A, E, M, N**), or set to track the pressure input using the binary format (**B, C, D, F, G, R**). (Default: **DA=B**)

NOTE:
 See **AN**, **H=**, **L=**, **O=**, and **W=** commands for customizing the analog output range (Applicable to **DA=A, B, C, D, E, F, and M** only).
 See the **NE** and **N=** commands for host processor control of the analog output (Applicable to **DA=G, N, and R** only).

EXAMPLES:

Inquiry: *dd**DA**

Action: *dd**WE** EEPROM Store: *dd**WE**
 *dd**DA**={**A|B|C|D|E|F|G|M|N|R|V**} *dd**SP**=**ALL**

	Digital Output Commands P1, P2	Digital Output Commands P3, P4	DAC Analog Output Voltage
A	Disabled (1)	Disabled (2)	Tracks Pressure
B	ASCII Format	Binary Format	Tracks Pressure
C	Disabled (1)	Binary Format	Last Value (3)
D	ASCII Format	Binary Format	Last Value (3)
E	ASCII Format	Disabled (2)	Tracks Pressure
F	Disabled (1)	Binary Format	Tracks Pressure
G	Disabled (1)	Binary Format	Tracks 'N=' Input (4)
M	ASCII Format	Disabled (2)	Last Value (3)
N	Disabled (1)	Disabled (2)	Tracks 'N=' Input (4)
R	ASCII Format	Binary Format	Tracks 'N=' Input (4)
V	ASCII Format	Binary Format	Disabled (5)

- (1) Output response to P1 command will be #ddCP=.. or ?ddCP=.. to indicate disabled. A P2 command request will be ignored or the P2 mode cancelled when the ASCII Format reply has been disabled.
- (2) Output response to P3 command will be xx???(for both CM=ON and CM=OFF). The 'xx' is the header character and the 6 most significant bits of the address. A P4 command request will be ignored or the P4 mode cancelled when the Binary Format reply has been disabled.
- (3) Output will remain at last value until a different DA mode is selected. After setting DA=C, D, or M, subsequent changes to H=, L=, O=, and W= have no effect upon the analog output or N= inquiry. Also, after setting DA=C, D, or M, subsequent IN=RESET or power-cycle will result in a fixed 0V analog output.
- (4) Analog output will track the N= values transmitted by a host processor. After a power-cycle or IN=RESET, and prior to a new N= setting, the analog output will be set to 0V.
- (5) When DAC is disabled, the analog output circuitry is turned off and the analog output will float. If this is not desired, select DA=G|N|R and set the analog output using the N= configuration.

DIFFERENCES FROM LEGACY PPT:

Parameters **O**, **S**, **T** and **U** were available for the PPT but have been removed for the PPT2.

A new parameter, **V**, has been added to provide a disabled DAC state. When selecting **DA=V**, all the analog output circuitry will be put into a shut-down mode.

It was possible for the PPT to issue a bandwidth warning with some DA parameter selections. This will not be necessary for the PPT2.

COMMAND CODE		COMMAND DESCRIPTION				
DS		Dead Band and Sensitivity Control				
Action Directing	Sequential Response with (90-99) address	Input or Output Type	Requires Write Enable	Terminates Continuous Commands	Can Write to EEPROM	Can Write to DAC
Yes	Before	Both	Yes (6)	No	Yes (9)	No

DETAILS:

The **Deadband** and **Sensitivity** control command allows the user to adjust the threshold value that causes a change in pressure reading. There are two options for this, **C** and **S**.

The **C** option sets the deadband to around the center of the pressure reading that moved it last. When the deadband is first set, the deadband will be split half above and half below the current reading. When the pressure exceeds either limit, the new pressure value becomes centered in the deadband limits.

The **S** option sets the deadband based on the peaks and valleys of the pressure level. For instance, when a small peak pressure is sensed, the top edge of the deadband will move to that pressure and have the entire deadband range below this value. The output reading will be one-half the deadband below this pressure (see Figure xx). As long as the pressure stays within the new deadband range the output will not change. If a pressure is sensed below this range, the deadband will move so that the bottom edge will be at that pressure and the entire deadband will be above this value.

(Default: **DS = 00S0**)

NOTE:

The **OP=U** command setting is typically used with the **DS** command to eliminate repetitive readings of the same pressure within the deadband range.

When the **W=S** command is used to establish an analog set point the deadband (**DS**) controls the set point null span (set point hysteresis).

See figures below for command illustrations using a 20 psi PPT2

*ddDS=40C1 (DS=40 sets deadband to ± 40 x 0.0005% FS. DS=C1 selects center option, 10x multiplier)

*ddDS=40S1 (DS=40 sets deadband to ± 40 x 0,005% FS. DS=S1 selects spread option, 10x multiplier)

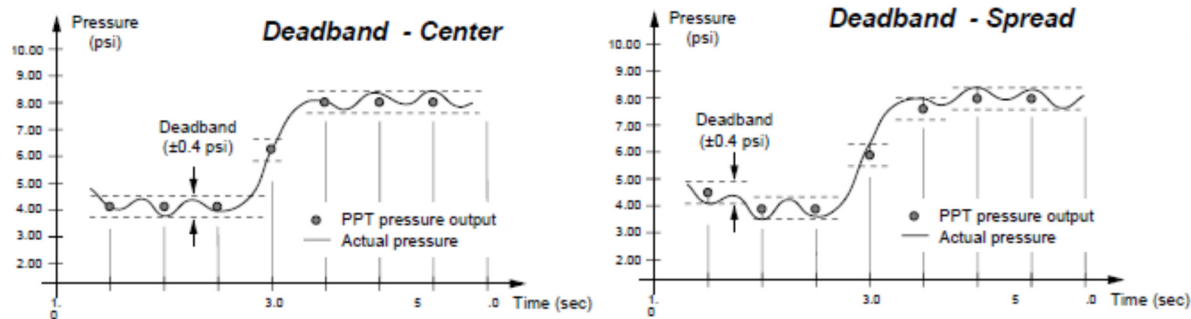

EXAMPLES:

Inquiry: *ddDS

Action: *ddWE

EEPROM Store: *ddWE

*ddDS= deadband or

*ddSP=ALL

*ddDS= Cn or

*ddDS= Sn

deadband 0 provides no deadband

1-60 provides *deadband* x 0.005% of full scale deadband limits

Note: The full scale for a 20 psig and a 20 psia is 20 psi,
but for a 20 psid it is 40 psi (-20 to +20 psi)

Note: *deadband* values of 1-9 must be requested without a leading zero.
However, subsequent inquiries will display a leading zero.

C Center deadband around each new pressure output change.

S Deadband **S**pread varies with the peaks and valleys of pressure changes.

n 0 or 1 – provides a deadband multiplier to allow the user to specify a wider set point null span where:

0 provides a 1x multiplier (deadband x 0.005% FS)

1 provides a 10x multiplier (deadband x 0.05% FS)

DIFFERENCES FROM LEGACY PPT:

No difference from PPT implementation.

COMMAND CODE		COMMAND DESCRIPTION					
DU		Display Units Control					
Action Directing	Sequential Response with (90-99) address	Input or Output Type	Requires Write Enable	Terminates Continuous Commands	Can Write to EEPROM	Can Write to DAC	
Yes	Before	Both	Yes (6)	No	Yes (9)	No	

DETAILS:

Set the **Display Units** for compensated pressure replies. A **USER** defined display unit can be set with this command that causes the pressure output to equal the value input by the **U=** command multiplied by the actual pressure in psi units. (Default: **DU=PSI**)

NOTE:

The PFS display unit will generally provide the best resolution. See page 13 for a table showing the number of digits to the right and left of the decimal place. After changing display units, the new units will not be available until the next integration (I=) cycle. Until then, P1 requests will result in either **#ddCP=...** or **?00CP=...** and P3 requests will result in **xx???** where the 'xx' is the header character and the 6 most significant bits of the address.

EXAMPLES:

Inquiry: *dd**DU** EEPROM Store: *dd**WE**
 *dd**SP=ALL**

Action: *dd**WE**

*dd**DU= { ATM|BAR|CMWC|FTWC|HPA|INHG|INWC|KGCM|KPA|MBAR|MMHG|MPA|MWC|PSI|USER|PFS }**

Display Unit	PSI Multiplier ^(a)	Units Description
ATM	0.068046	ambient atmosphere at sea level
BAR	0.068948	bar (10 ⁵ newtons/meter ²)
CMWC	70.304	centimeters of water column (4 °C)
FTWC	2.3065	feet of water column (4 °C)
HPA	68.948	hectopascal (1 millibar)
INHG	2.0360	inches of mercury (0 °C)
INWC	27.679	inches of water column (4 °C)
KGCM	0.070307	kilograms/centimeter ²
KPA	6.8948	kilopascal
MBAR	68.948	millibar (1 hectopascal)
MMHG	51.714	millimeters of mercury (0 °C) or torr
MPA	0.0068948	megapascal
MWC	0.70304	meters of water column (4 °C)
PSI	1.0000	pounds per square inch
USER	0.0010000-999.99	user supplied (see also U= command)
PFS	FS=100.0000	percent of full scale in 0.0001% increments

⁽¹⁾ From the *CRC Handbook Of Tables For Applied Engineering Science*

DIFFERENCES FROM LEGACY PPT:
 LCOM is removed. HPA (equivalent to MBAR) is added.

COMMAND CODE		COMMAND DESCRIPTION				
DX		DAC Slope Compensation Control				
Action Directing	Sequential Response with (90-99) address	Input or Output Type	Requires Write Enable	Terminates Continuous Commands	Can Write to EEPROM	Can Write to DAC
Yes	After (4)	Both	Yes (6)	No	Yes (9)	No

DETAILS:
 The user can adjust analog output using **DX** and **DZ** commands. The **DX** command adjusts the slope of the analog output. The algorithm for the **DX** adjustment is shown below.
 Attempting to set **DX** > 300 will result in **DX=300**. Attempting to set **DX** < -300 will result in **DX=-300**.
 If there is an input error, then the command error flag in the **RS** command will be set and no change will occur. See Figure below for command illustration with the default 5 volts Full Scale. (Default: **DX=0**)

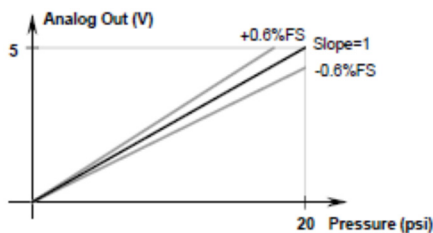

NOTE:
 Offset corrections (**DZ**) to the analog output should be performed prior to any slope adjustments (**DX**).
 To adjust, set the output to 5V using the **NE** and **N=** commands and then determine the amount of required DAC slope correction per the equation below.

EXAMPLES:

Inquiry: *dd**DX**

Action: *dd**WE** EEPROM Store: *dd**WE**
 *dd**DX=ppp** *dd**SP=ALL**

ppp **0 to ±300** This value is either increases or decreases the analog output slope correction as shown below:

At 5 volts, each count of correction represents 100 μ V of slope correction.

$$\text{Desired Output} = ((\text{Unadjusted Output}/5.000 \text{ volts}) \times (ppp \times 100 \mu\text{V}) + \text{Unadjusted Output})$$

DIFFERENCES FROM LEGACY PPT:
 Not implemented in the PPT.

COMMAND CODE		COMMAND DESCRIPTION				
DZ		DAC Offset Compensation Control				
Action Directing	Sequential Response with (90-99) address	Input or Output Type	Requires Write Enable	Terminates Continuous Commands	Can Write to EEPROM	Can Write to DAC
Yes	After (4)	Both	Yes (6)	No	Yes (9)	No

DETAILS:

The user can adjust analog output using DX and DZ commands. The DZ command adjusts the offset of the analog output. The algorithm for the DZ adjustment is shown below.

If there is an input error, then the command error flag in the RS command will be set and no change will occur. See Figure below for command illustration with the default 5 volts Full Scale. (Default: DZ=0)

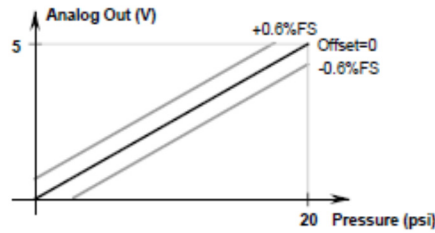

NOTE:

The N= command should be used in conjunction with the DZ command. When changing DZ= settings, set N=0 and determine how much correction is required. (See the N= command description for steps to set the analog output.) Offset corrections to the analog output should be performed prior to any slope adjustments (DX). To adjust, set the output to 0V using the NE and N= commands and then determine the amount of required DAC offset correction in 100 µV increments. If the output is high by 300 µV, DZ should be adjusted by -3.

EXAMPLES:

Inquiry: *dd**DZ**

Action: *dd**WE**

EEPROM Store: *dd**WE**

*dd**Z**={*qqq*}

*dd**SP**=**ALL**

qqq **0 to ±300** Where each count added or subtracted represents 100 µV of offset adjustment.

DIFFERENCES FROM LEGACY PPT:

Not implemented in the PPT.

COMMAND CODE		COMMAND DESCRIPTION												
F=		Customized Full Scale Range												
Action Directing	Sequential Response with (90-99) address	Input or Output Type	Requires Write Enable	Terminates Continuous Commands	Can Write to EEPROM	Can Write to DAC								
Yes	After (4)	Both	Yes (6)	No	Yes (9)	Yes								
<p>DETAILS: The F= command is used in conjunction with the X=, Y=, and Z= command to customize the full scale range and user compensation of the PPT2. The F= command allows the user to reduce the full scale range of the PPT2 by at least one-half the FS value (M=). Some units may allow up to 10x reduction of the full scale value. The F= command value can have up to 5 significant digits with a decimal point. Enter an F=0 command to disable this function and return to the factory default (M=) full scale value. The new F= value becomes the standard FS number used for other commands and range calculations. (Default: F=0.0000)</p>														
<p>NOTE: The transducer's accuracy specification is always referenced to the factory (M=) full scale value. After the F= command is changed, ensure all parameters are stored in EEPROM using the SP=ALL command. The response to an F= inquiry will yield both the value and the pressure units that were active when the F= value was set. Example response: #01F=1000.0 MBAR Changes to the F= value will cause any existing Z= value to be recalculated; up to the limit of valid Z= values (± 6000). A new F= value will not become effective until the next integration/averaging cycle.</p>														
<p>EXAMPLES: Inquiry: *ddF=</p> <table border="0" style="width: 100%;"> <tr> <td style="width: 15%;">Action:</td> <td style="width: 35%;">*ddWE</td> <td style="width: 35%;">EEPROM Store:</td> <td style="width: 15%;">*ddWE</td> </tr> <tr> <td></td> <td>*ddF=FSnum</td> <td></td> <td>*ddSP=ALL</td> </tr> </table> <p><i>FSnum</i> This value can have up to 5 significant digits with a decimal point. First, select the display units desired (except for USER, or PFS) using the DU command. Now, <i>FSnum</i> is the desired full scale value in those display units. [For some display units it may not be possible to set the pressure ranges using only 5 digits. Try changing to a different display unit and then set the F= range.]</p>							Action:	*dd WE	EEPROM Store:	*dd WE		*dd F=FSnum		*dd SP=ALL
Action:	*dd WE	EEPROM Store:	*dd WE											
	*dd F=FSnum		*dd SP=ALL											
<p>DIFFERENCES FROM LEGACY PPT: Unlike the PPT, the PPT2 will display both the value and display units in response to an F= inquiry. For example: *01F= #01F=10.000 PSI The display units in the F= response may not be the same as the current display units (DU).</p>														

COMMAND CODE		COMMAND DESCRIPTION				
FD		Factory Defaults				
Action Directing	Sequential Response with (90-99) address	Input or Output Type	Requires Write Enable	Terminates Continuous Commands	Can Write to EEPROM	Can Write to DAC
Yes	No	In	Yes	No	No	No
<p>DETAILS: Each PPT2 is supplied with a copy of its factory default settings stored in static memory. The Factory Defaults command causes these default settings, with the exception of baud rate, parity, and ID, to be copied from static memory into the working RAM of the PPT2 microprocessor. A subsequent store parameters command (SP=ALL) is required to store the defaults into static configuration memory so they are available after power is cycled.</p>						
<p>NOTE: This command will not work when a *ddWE=RAM continuous write enable is active. It must have a singular write enable (*ddWE) command preceding it. FD=ALL, FD=AL, and FD=A are all valid commands. The FD command cancels all continuous commands currently in process.</p>						
<p>EXAMPLES: Action: *ddWE *ddFD= All Copies factory default settings into PPT2 RAM.</p>						
<p>DIFFERENCES FROM LEGACY PPT: This command was not available on the PPT.</p>						

COMMAND CODE		COMMAND DESCRIPTION				
H=		Highest Analog Voltage				
Action Directing	Sequential Response with (90-99) address	Input or Output Type	Requires Write Enable	Terminates Continuous Commands	Can Write to EEPROM	Can Write to DAC
Yes	After (4)	Both	Yes (6)	No	Yes (9)	Yes (11)

DETAILS:

Sets the DAC High analog output voltage full scale (FS) reading. The input is a value from 0.02 to 100% of 5 volts, or 1 millivolt per count. An **H=** inquiry reads the value in 1 millivolt counts. This command is used in conjunction with the **L=**, and **AN** commands to customize the range of the PPT2 analog voltage output see Figure below. If there is an input error, then the command error flag in the **RS** command will be set and no change will occur. (Default: **H=5000**)

Analog output customized for 1(L = 1000) to 4.85 (H = 4850) volts out, rather than the default 0 to 5 volts.

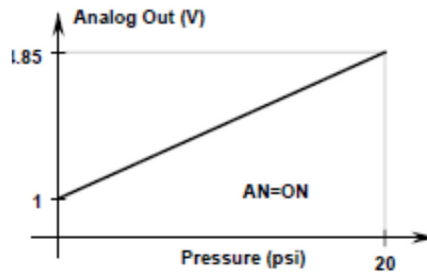

NOTE:

See the **L=** command for setting the low analog output voltage. See the **AN** command for enabling and disabling the **H=** and **L=** settings and for the effect on analog resolution. If attempting to set the **H=** value to less than or equal the **L=** value, no change will occur and an **RS** command error will result.

EXAMPLES:

Inquiry: *dd**H=**

Action: *dd**WE**

EEPROM Store: *dd**WE**

*dd**H=pppp**

*dd**SP=ALL**

pppp **0 - 5000** (mV) This number sets the full scale (FS) analog voltage as an integer value of millivolts. An **H=0** setting will set the high level to 5000 mV. As an example, H=4250 corresponds to a FS voltage of 4.25 volt An **H=** entry greater than 5000 will set **H=5000**.

DIFFERENCES FROM LEGACY PPT:

PPT implementation only uses H= values of 0 to 100.

COMMAND CODE		COMMAND DESCRIPTION				
IC		Idle Count Parameter				
Action Directing	Sequential Response with (90-99) address	Input or Output Type	Requires Write Enable	Terminates Continuous Commands	Can Write to EEPROM	Can Write to DAC
Yes	Before	Both	Yes (6)	No	Yes (9)	No
<p>DETAILS: The Idle Count parameter specifies the number of pressure integration times that the microprocessor skips between output values (see Fig. x.xx). This command is only operational for the I=Mn form of the Integration Time (I=) command. (See the I= command for setting integration times.) This parameter can be used to reduce the average transducer power requirement by as much as 50-60% when increased response time is acceptable (see OP command description). This parameter is also used to reduce the reply message traffic on the network bus from PPT2s whose response time is not critical. (Default: IC=0)</p>						
<p>NOTE: Note: If the OP=W (watchdog timer) command is set, then the IC command will not execute (other than IC=0) and will cause a RS command error condition. The transducer's average power requirement will begin to reduce when I≥M20 and IC>0, yielding "quiet times" of 200 ms or greater. See OP command description for additional information on power saving modes. P1 or P3 requests during quiet times will return the previously calculated pressure reading.</p>						
<p>EXAMPLES: Inquiry: *ddIC Action: *ddWE EEPROM Store: *ddWE *ddIC=ICcount *ddSP=ALL <i>ICcount</i> 0 to 255 where: 0 causes all integration cycles to be used. 1 causes 1 of 2 integration cycles to be used. 2 causes 1 of 3 integration cycles to be used. 255 causes 1 of 256 integration cycles to be used.</p>						
<p>DIFFERENCES FROM LEGACY PPT: PPT likely has slightly different power saving implementation.</p>						

COMMAND CODE		COMMAND DESCRIPTION				
ID		Identification Number				
Action Directing	Sequential Response with (90-99) address	Input or Output Type	Requires Write Enable	Terminates Continuous Commands	Can Write to EEPROM	Can Write to DAC
Yes	Before	Both	Yes (6)	No	Yes (9)	No

DETAILS:

Set the device **ID**entification number. This command is used to set a unique PPT2 address and/or a group address. Two sections below describe this command based on the RS-232 or RS-485 type of unit. (Default: device **ID=00**, group address=**90**)

RS-232 type only

To unassign all device IDs, send a ***99WE** and a ***99ID=00** command. In this case, all the PPT2 units in the network will set their device IDs to address '00', the null address.

To sequentially assign device IDs on an RS-232 ring network, send ***99ID=01**. The first unit will number itself **ID=01**, increment the command and automatically send a ***99ID=02** to the next transducer in line. This will continue down the ring until all of the transducers have sequentially numbered themselves. The host processor will receive: ***99ID=nn**, where nn= the number of transducers in the network plus 1. For example, if 6 transducers are connected in a network, then a ***99ID=01** command will sequentially assign device IDs to all six units and return a ***99ID=07** to the host processor. Note that ID=01 must be entered and not just ID=1. The transducers will now be sequentially assigned device IDs from 01 to 06.

Inquiry:***ddID** (reply is group number)

Action: ***ddWE** EEPROM Store: ***ddWE**
 ***ddID=newNumber** ***ddSP=ALL**

newNumber 00 – 99 (must enter a **TWO** digit decimal number)

where: 00 Unit numbers itself '00' (null address) and transmits the message unchanged. A ***99ID=00** will change all PPT2s in network to null address (see **Note** below).
 01-88 Unit numbers itself with device ID *newNumber*, increments the number by 1, and transmits the message. This will sequentially number all PPT2s in a network, starting from unit dd, with ID=*newNumber* (see **Note** below).
 89 Unit numbers itself with device ID '89', changes the number to '99', and transmits the message.
 90-98 Unit assigns itself group address *newNumber*, and transmits the message unchanged.
 99 Unit does not change its address, changes *newNumber* to 'ER' and transmits the message.
 ER Unit does not change its address and transmits the message unchanged.

RS-485 type only

RS-485 units have a factory-default identification address of 00. The PPT2 will not respond to group or global commands until it is assigned a non-zero address. Similarly, RS-485 units have a factory-default sub-address of 00. The PPT2 will not respond to group commands until it is assigned a non-zero sub-address. This can be accomplished by the following methods:

1) An identification address can be assigned off-line by connecting the PPT2 to an RS-485 compatible serial port. The command sequence to assign address 01 is:

```
*00WE  
*00ID=01  
*01WE  
*01SP=ALL
```

If global addressing is to be used for PPT2 responses, then all PPT2's that are to respond to global requests

must be addressed sequentially starting with address 01. See the **TO** command description for further information on RS-485 global addressing.

If group addressing is to be used for PPT2 responses, then all PPT2's within a single group must have a group sub-addresses assigned sequentially starting with address 01. (The valid range of assigned sub-addresses is 01 - 99.) The command sequence to assign group address 91 and sub-address 01 to a PPT2 with identification address 03 is:

```
*03WE
*03ID=9101
*03WE
*03SP=ALL
```

See the **TO** command description for further information on RS-485 global addressing.

2) If the PPT2s to receive ID addresses have null addresses, they can be installed on the RS-485 bus *one at a time*. After each PPT2 is connected, its ID address can be assigned by using the above procedure.

3) Any number of null addressed, or unknown addressed, PPT2s can be connected to a RS-485 bus and have ID individually assigned by using their serial numbers as unique identifiers. The command sequence to assign the address 02 to a PPT2 with serial number 3175 is:

```
*99WE
*99S=00003175 (must use all 8 numbers)
*99WE
*99ID=02
*02WE
*02SP=ALL
```

When the identification address has been assigned, group address and sub-address can be assigned in the same manner as in 1) above.

NOTE:

Regardless of communications type (RS-232 or RS-485), it is recommended that any network of more than 1 unit be configured with unique sequential ID's. For example, a network of 3 units should be addressed with 01, 02, and 03.

For RS-485 units, all ***9xID=** commands are ignored unless the command has been preceded by a serial number command (***99S=ssssssss**) with the serial number that matches that unit. The next ***9xID** command will set that unit's device ID number.

EXAMPLES:

See DETAILS above.

DIFFERENCES FROM LEGACY PPT:

No difference from PPT implementation.

COMMAND CODE		COMMAND DESCRIPTION				
IN		Initialize PPT2 Microprocessor				
Action Directing	Sequential Response with (90-99) address	Input or Output Type	Requires Write Enable	Terminates Continuous Commands	Can Write to EEPROM	Can Write to DAC
No (2)	No	In	No	Yes	No	No
<p>DETAILS: This command INitializes the PPT2 microprocessor. When this command is sent with the RESET option, it performs the same start-up function as removing and re-applying power to the PPT2 (exceptions to this are described in the MO command).</p>						
<p>NOTE: When stopping continuous readings (P2, P4, T2) with the IN command, as many as two additional readings may be seen after the receipt of the IN.</p>						
<p>EXAMPLES:</p> <p>Action: *ddIN</p> <p style="padding-left: 40px;">This stops a continuous read operation but does not perform a power-on reset. All RAM stored parameters are retained.</p> <p>Action:*ddIN=RESET</p> <p style="padding-left: 40px;">This stops any current operation and then performs a microprocessor reset. If the command has a group or global address (90-99), the message is re-transmitted before the power-on reset is activated. Subsequently, all RAM parameters are replaced with previously stored parameters from EEPROM. See MO command for reset options.</p>						
<p>DIFFERENCES FROM LEGACY PPT: No difference from PPT implementation.</p>						

COMMAND CODE		COMMAND DESCRIPTION				
L=		Lowest Analog Output Voltage				
Action Directing	Sequential Response with (90-99) address	Input or Output Type	Requires Write Enable	Terminates Continuous Commands	Can Write to EEPROM	Can Write to DAC
Yes	After (4)	Both	Yes (6)	No	Yes (9)	Yes (11)

DETAILS:

Set the DAC Low analog output voltage zero reading for absolute and gauge units and the most negative reading for differential units. The input is a value from 0 to 99.98% of 5 volts, or 1 millivolt per count. An **L=** inquiry reads the value in 1 millivolt counts. This command is used in conjunction with the **H=**, and **AN** commands to customize the range of the PPT2 analog voltage output –see Figure below. If there is an input error, the command error flag in the **RS** command will be set and no change will occur. (Default: **L=0**)

Analog output customized for 1(L = 1000) to 4.85 (H = 4850) volts out, rather than the default 0 to 5 volts.

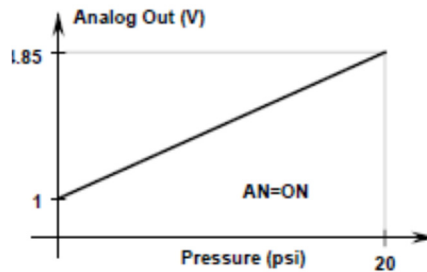

NOTE:

See the **H=** command for setting the high, full scale, analog output voltage. See the **AN** command for enabling and disabling the **H=** and **L=** settings. If **L=** value \geq **H=** value, then no change will occur and an **RS** command error will result.

EXAMPLES:

Inquiry: *ddL=

Action: *ddWE

EEPROM Store: *ddWE

*ddL=pppp

*ddSP=ALL

pppp **0 - 4999** This number sets the zero reading for absolute and gauge units and most negative reading for differential units as an integer percentage of 5.00 volts. It can also be thought of as a multiplier in 1 millivolt increments. As an example, L=1500 corresponds to a zero reading voltage of 1500 millivolts or 1.5 volts. For **L=0**, the low voltage will be 0V. For **L>4999**, no change will occur and an RS command error will result.

DIFFERENCES FROM LEGACY PPT:

The PPT uses a 12-bit DAC versus the PPT2 16-bit DAC. The PPT only allowed values of 0 - 99 in increments of 50 mV.

COMMAND CODE		COMMAND DESCRIPTION				
M=		Maximum Customized Full Scale				
Action Directing	Sequential Response with (90-99) address	Input or Output Type	Requires Write Enable	Terminates Continuous Commands	Can Write to EEPROM	Can Write to DAC
Yes	After (4)	Out	No	No	No	No

DETAILS:
 This command identifies the **Maximum full scale pressure**, in psi units, that can be user-customized (see **F=** command).
 This value is fixed at the factory and corresponds to the full scale reference value for accuracy and error determination.

NOTE:
 Typical response is **#ddM=0100psid**, where the first 4 characters indicate the pressure range and the last 4 characters indicate the type (psia, psid, psig).

EXAMPLES:

Inquiry: *ddM=

RS-485 type only

This command is used to select the PPT2 alternate message header set of non-printing characters. This can be used when there is a conflict between the standard PPT2 message headers and the message characters used by some other components that share the bus.

To change from standard to alternate headers:

```
Action:   *ddWE                               EEPROM Store: (ctrl \) ddWE
           *ddM=ALT                           (ctrl \) ddSP=ALL
```

To change from alternate to standard headers:

```
Action:   (ctrl \) ddWE                       EEPROM Store: *ddWE
           (ctrl \) ddM=ALT                   *ddSP=ALL
```

<u>Standard Header</u>		<u>Alternate Header</u>	<u>ASCII Name (1)</u>
*	becomes	ctrl \	FS
\$	becomes	ctrl]	GS
#	becomes	ctrl _	US
{	becomes	ctrl Q	DC1
}	becomes	ctrl R	DC2
!	becomes	ctrl S	DC3
@	becomes	ctrl T	DC4

DIFFERENCES FROM LEGACY PPT:
 PPT2 will not store the factory D= register information with parity bits. There will be no parity error checking for the M= response.

COMMAND CODE		COMMAND DESCRIPTION				
N=		Send Number to DAC				
Action Directing	Sequential Response with (90-99) address	Input or Output Type	Requires Write Enable	Terminates Continuous Commands	Can Write to EEPROM	Can Write to DAC
No (3)	After (4)	Both	No (7)	No	No	Yes (11)
<p>DETAILS: The analog N= command is used to apply an ASCII decimal format value to the DAC for direct host processor control of the analog output. Before executing this command the digital and analog control must be set to DA=G, N, or R and the analog write enable must be activated - *ddNE, or *ddNE=DAC. If there is an input error, then the command error flag in the RS command will be set and no change will occur. The N= value sent to the DAC is not continuously updated. The DAC is not updated until receipt of a new N= value or a change in the DA setting. After a power-cycle or IN=RESET, and prior to a new N= setting, the analog output will be set to 0V, if the DA setting was saved to EEPROM (SP = ALL).</p>						
<p>NOTE: In "normal" operation (DA=A, B, E, or F), the DAC is continuously updated at a rate determined by the I= and IC settings, with each update compensated for temperature effects. When DA=G, N, or R, the DAC is only updated upon receipt of a new N= value. If the PPT2 temperature changes, the DAC output may not be correctly temperature compensated until receipt of the next N= command. Also, when controlling the analog output with the N= command, changes to DX and DZ compensation will only be applied to the analog output after a subsequent N= command.</p> <p>This command may be used to read the digital input value at the DAC at any time, without requiring an enable and regardless of the state of the DA command. An exception is the state of DA=V which will always result in N=0000.0.</p>						
<p>EXAMPLES: Inquiry: *ddN= Action: *ddNE *ddN= dddd dddd Decimal digits in the range 0 to 5000.0 which controls the DAC analog voltage. The first 5 digits, or until the first digit past the decimal point, are input to the dddd value. This value can be expressed in millivolts (N=4000 for 4.000 volts) or in millivolts to the tenths of millivolts digit (N=4234.1 for 4.2341 volts). The dddd value is adjusted by DX and DZ settings. The value dddd is <u>not</u> modified by the O=, W=, H=, or L= settings if activated.</p>						
<p>DIFFERENCES FROM LEGACY PPT: PPT value is modified by O=, W=, H=, or L= settings. PPT also allows setting DAC output with '~' command.</p>						

COMMAND CODE		COMMAND DESCRIPTION												
O=		Offset Pressure Window												
Action Directing	Sequential Response with (90-99) address	Input or Output Type	Requires Write Enable	Terminates Continuous Commands	Can Write to EEPROM	Can Write to DAC								
Yes	After (4)	Both	Yes (6)	No	Yes (9)	Yes (11)								
<p>DETAILS: Offset the analog pressure window to reassign the minimum pressure value for the lowest analog output. This command sets a pressure offset value from 0 to 99.95% of full scale in increments of 0.05%FS. This command is used with the W=, L=, and H= commands to customize the size of the PPT2 analog output window and analog output voltage. This command has no effect on the digital readings. This command is enabled by the AN command. If there is an input error, then the command error flag in the RS command will be set and no change will occur. (Default: O=0)</p> <p>For example when L=0 and H=0, if a 20 psia (or 20 psig) unit had the offset window set to O=400, then the analog 0V output would begin at 4 psi (20% of 20 psi) and be rescaled to 5V at 20 psi. Use the W= command (W=1600) to adjust the span if only a portion of the remaining range is of interest. If the range of 4psi to 16psi is desired to be windowed onto the 0 to 5 volt scale then a W=1200 would be used (60% of 20=12 psi) + 4 psi = 16 psi FS.</p> <p>If a 20 psid unit had the offset pressure window set to O=400, then the offset pressure would be 8 psi (20% of 40 psi). The analog 0V output would begin at -12 psi, cross 2.5V at 4 psi, and output 5V at 20 psi. If the W= value was > 1600, then it is automatically set to 1600.</p>														
<p>NOTE: The sum of W= value and O= values cannot exceed 2000. If the existing W= value + newly selected O= value > 2000, the existing W= value will automatically be adjusted such that O= value plus W= value equals 2000.</p>														
<p>EXAMPLES:</p> <p>Inquiry: *ddO=</p> <table> <tr> <td>Action:</td> <td>*ddWE</td> <td>EEPROM Store:</td> <td>*ddWE</td> </tr> <tr> <td></td> <td>*ddO=pppp</td> <td></td> <td>*ddSP=ALL</td> </tr> </table> <p><i>pppp</i> 0 - 1999 This number is a 0.05 percent (%) multiplier of the full scale pressure that sets the minimum pressure value corresponding to the lowest analog output. It can also be thought of as an offset, or sliding, of the pressure window. For O=0, the offset is zero pressure and the original pressure value for 0V (or L= value) output is used. For O>1999, the pressure offset window will be 99.95%FS.</p>							Action:	*dd WE	EEPROM Store:	*dd WE		*dd O=pppp		*dd SP=ALL
Action:	*dd WE	EEPROM Store:	*dd WE											
	*dd O=pppp		*dd SP=ALL											
<p>DIFFERENCES FROM LEGACY PPT: PPT only allowed settings of 0-99, each count representing 1%FS.</p>														

COMMAND CODE		COMMAND DESCRIPTION				
OP		Operating Mode parameters				
Action Directing	Sequential Response with (90-99) address	Input or Output Type	Requires Write Enable	Terminates Continuous Commands	Can Write to EEPROM	Can Write to DAC
Yes	Before	Both	Yes (6)	No	Yes (9)	No
<p>DETAILS: Sets the OPerating mode parameters for the number of decimal places, checksum usage, sequential read control for pressure readings, watchdog timer feature, and sleep modes. If enabled, the watchdog timer will perform an automatic system reset, similar to an IN=RESET command, if the PPT2 becomes interrupted due to external influences. This option is useful in applications that are subject to electrical noise, power glitches, electrostatic discharges, etc., or where high reliability is required. (Default: OP=ANEXI)</p>						
<p>NOTE: If the IC command is set to any value other than IC=0, then the OP=W command will not set and cause a RS command error condition. Descriptions below for OP=N C and OP=E F R S assume CM=OFF. With CM=ON, P1-P4 pressure readings have resolution compatible with the Honeywell PPT2 pressure transducer. See the CM command for more information.</p>						
<p>EXAMPLES: Inquiry: *ddOP Action: *ddWE EEPROM Store: *ddWE *ddOP={A U} or *ddOP={N C} or *ddSP=ALL *ddOP={E F R S} or *ddOP={X W}</p> <p>A Transmit <u>all</u> readings for sequential requests and continuous mode. U Transmit <u>only changed</u> pressure readings for sequential requests and continuous mode. Note: See DS command for controlling the amount of pressure deviation that is detected as a change. Upon receipt of a P2 or P4 command, the PPT2 will send one reading and then wait for a pressure change before sending another. Also, when OP=U and MO=P2/P4, a power-up or IN=RESET will generate a single reading and then wait for a pressure change before sending another.</p> <p>.....</p> <p>N No checksum. C Apply an integrity Checksum to the binary format readings. When all of the characters in the message, including the header and this character, are added together (with carries) the least significant six bits of the resultant sum will be zero. Do not include the <cr>; that is, if you add the 6 least significant bits of the – header, 5 data, and checksum – characters, with carries, the 6 least significant bits of the result will be zeroes (see Appendix A for the list of characters to be used.)</p> <p>.....</p> <p>E Extended form for the commands (P3, P4) using the binary format. This yields a 7 bit binary device address and a 23 bit magnitude for the pressure reading. The pressure sign is encoded in the header character. F Fixed sign position provides the same function as E option above but forces a sign position for the P1 and P2 readings. With this option the pressure readings do not shift positions when the sign changes from + to - on gauge and differential PPT2s. R Remove header characters from P1 and P2 pressure readings with fixed sign position. The first transmitted byte will be the pressure sign character followed by the pressure value and a <cr>. In this mode, there is no device ID number or indication of out-of-range pressure condition in the P1 and P2 modes. S Signed form for the commands (P3, P4,) using the binary format. This yields a 7 bit binary device address and a sign + 22 bit magnitude for data.</p> <p>.....</p> <p>X No watchdog timer enabled. W Watchdog timer enabled resulting in PPT2 reset if it should stop for > 5 ms. After reset, the PPT2 will display “WDT_ _RESET_ _ERROR” in the startup message, regardless of</p>						

MO settings, and a flag will be set in the RS command response.

- I** "Idle" mode (default) when $I \geq M20$ and $IC > 0$. PPT2 electronics enter a lower power mode during the idle time between integrations. Power savings of 10-20 percent can be expected.
- D** "Deep Sleep" mode when $I \geq M20$ and $IC > 0$. PPT2 electronics will enter a sleep deep mode during the idle time between integrations. Power savings of 50-60 percent can be expected. However, any incoming characters will wake the device and place it into "Idle" mode.

As such, this mode cannot be stored and all subsequent inquiries will indicate $OP=I$. To effectively utilize this mode, first place the transducer into a continuous transmit mode followed by setting $OP=D$.

NOTE: Timing between continuous readings may not be accurate while in Deep Sleep mode. During Deep Sleep mode the PPT2 utilizes an internal RC oscillator which has a tolerance of $\pm 60\%$.

DIFFERENCES FROM LEGACY PPT:

PPT command description mentioned A/D pressure conversion counts in $OP=E$ and $OP=S$, in an attempt to demonstrate the effect of 17 bit or 16 bit data. That information has been removed from PPT2 description. CM command will impact the operation of OP. CM was not available with the PPT.

$OP=I|D$ is a new option on the PPT2. The PPT had only one power saving mode.

COMMAND CODE		COMMAND DESCRIPTION				
P=		Production Date				
Action Directing	Sequential Response with (90-99) address	Input or Output Type	Requires Write Enable	Terminates Continuous Commands	Can Write to EEPROM	Can Write to DAC
No	After (4)	Out	No	No	No	No
<p>DETAILS: The Production date command reads the factory set PPT2 manufactured date with format mm/dd/yy.</p>						
<p>NOTE:</p>						
<p>EXAMPLES:</p> <p>Inquiry: *ddP=</p>						
<p>DIFFERENCES FROM LEGACY PPT: No difference from PPT implementation.</p>						

COMMAND CODE		COMMAND DESCRIPTION				
P1		Pressure, Single, ASCII Format				
Action Directing	Sequential Response with (90-99) address	Input or Output Type	Requires Write Enable	Terminates Continuous Commands	Can Write to EEPROM	Can Write to DAC
No	Before (5)	Out	No	No	No	No
<p>DETAILS: The P1 command requests a temperature compensated pressure (CP) reading in ASCII format. Refer to page 7 for decimal placement and significant digits. The OP=A or U 'all or changes only' parameter controls the output. If this command is executed while a P2, P4, T2, or T4 command is executing, then one ASCII pressure reading is transmitted and the continuous command resumes operation.</p>						
<p>NOTE: The PPT2 continuously integrates (see I= command) and calculates pressure and temperature readings. When this command is received, the latest available reading is transmitted.</p>						
<p>EXAMPLES: Inquiry: *ddP1 A response of #ddCP!0.000 either indicates the pressure is at zero and a temperature over/under range occurred or an error occurred in the PPT2 memory . Check RS for specific error. A response of #01CP=. indicates a pressure reading is not yet available. Try again. This response may be a result of a P1 request after a CK or SP=ALL request. #01CP=. may also be seen immediately after a power-up cycle and before valid data is available (long integration time). #01CP=. will also be the result when the ASCII output has been disabled using the DA command</p>						
<p>DIFFERENCES FROM LEGACY PPT: The PPT will reject any commands after an IN=RESET command and before the first integration cycle is complete. For example, if a PPT has an integration setting of I=M100, it will be 10 seconds after an IN=RESET before it will accept ANY commands. The PPT2 will respond to all commands immediately after initialization is complete, even if the response is only #01CP=.</p>						

COMMAND CODE		COMMAND DESCRIPTION				
P2		Pressure, Continuous, ASCII Format				
Action Directing	Sequential Response with (90-99) address	Input or Output Type	Requires Write Enable	Terminates Continuous Commands	Can Write to EEPROM	Can Write to DAC
No (3)	After	Out	No	Yes (8)	No	No
<p>DETAILS: The P2 command requests continuous temperature compensated pressure readings in ASCII format. The reading rate is controlled by the I=, IC, and OP command settings. See the DO=P or N commands for the suspend readings options. For RS-485 mode, the TO=C command must be set to transmit continuous readings. Also, see the response descriptions in the P1 command description.</p>						
<p>NOTE: For RS-485 units, when the continuous transmit parameter is NOT active (is not set to TO=C), the P2 command sends only one reading. For multiple RS-232 units in a network, type a \$*99IN to stop this command. The '\$' is sent through the entire network and suspends the pressure readings while the *99IN command disables the continuous output function. For a single RS-232 unit, *ddIN will both suspend and disable the output function. For single RS-485 units (with TO=C) type a *ddIN to stop this command. (It is not recommended to have more than one unit continuously broadcasting pressure in an RS-485 network.) It is recommended that continuous broadcast be interrupted before sending other action or inquiry commands, especially when the PPT2 is broadcasting multiple readings per second. If a P2 command is sent in the midst of a PPT2 integration cycle, the first reading will not occur until the integration cycle is complete. This is most noticeable with long duration integration settings. If P2 continuous transmission is already active, subsequent P2 commands will be ignored and readings will continue to be transmitted at a rate determined by the I=, IC, and OP settings.</p>						
<p>EXAMPLES: Inquiry: *ddP2 Type: *ddIN Disable continuous pressure readings for a single PPT2 (RS-232 or RS-485) Type: \$*99IN To disable continuous pressure readings for all RS-232 PPT2s in a network.</p>						
<p>DIFFERENCES FROM LEGACY PPT: See P1 command differences.</p>						

COMMAND CODE		COMMAND DESCRIPTION				
P3		Pressure, Single, Binary Format				
Action Directing	Sequential Response with (90-99) address	Input or Output Type	Requires Write Enable	Terminates Continuous Commands	Can Write to EEPROM	Can Write to DAC
No	Before (5)	Out	No	No	No	No
<p>DETAILS:</p> <p>The P3 command produces a single binary encoded temperature compensated pressure reading:</p> <p>[With CM=OFF] 7 byte binary format; 1 byte header, 5 bytes encoded address and pressure data, and 1 byte <cr> char.</p> <p>[With CM=ON] 6 byte binary format; 1 byte header, 4 characters of encoded address and pressure data, 1 byte <cr> char.</p> <p>The OP=A or U 'all or changes only' parameter controls the output. If this command is executed while a P2, P4, or T2 command is executing, then one single binary format pressure reading is transmitted and the continuous command resumes operation. The OP command also controls whether an integrity checksum is to be inserted between the last data byte and the <cr> character. See OP command for checksum calculation.</p>						
<p>NOTE:</p> <p>See notes in P1 command.</p> <p>(see Appendix A – PPT2 Binary Command Format for P3 and P4 Commands). Refer to page 7 for default decimal placement and significant digits.</p> <p>When CM=ON (PPT2compatibility mode) the P3 command produces a shorter PPT-compatible binary encoded temperature compensated pressure reading – 6 byte binary format; a 1 byte header, 4 bytes encoded address and pressure data, and 1 byte <cr> character.</p>						
<p>EXAMPLES:</p> <p>Inquiry: *ddP3</p> <p>Typical reply: { @!160 Binary format compensated pressure reading from device ID=01 is 46.6352 mWC; refer to Table x.x and x.x</p> <p>If reply is: xx??? Binary format compensated pressure reading not available, a memory error has occurred, or it has been disabled. The 'xx' is the header character and the 6 most significant bits of the address. Response is xx??? for both CM=ON and CM=OFF.</p>						
<p>DIFFERENCES FROM LEGACY PPT:</p> <p>Default PPT2 implementation is 7 bytes versus 6 bytes for the PPT. Also, if a reading is not available, the only PPT2 response is xx??? where xx is the header character and 6 bits of address. The PPT also allows a response of xx_?? to indicate no reading is available.</p>						

COMMAND CODE		COMMAND DESCRIPTION				
P4		Pressure, Continuous Binary Format				
Action Directing	Sequential Response with (90-99) address	Input or Output Type	Requires Write Enable	Terminates Continuous Commands	Can Write to EEPROM	Can Write to DAC
No (3)	After	Out	No	Yes (8)	No	No
<p>DETAILS: The P4 command produces a continuous stream of binary encoded temperature compensated pressure readings:</p> <p>[With CM=OFF] 7 byte binary format; 1 byte header, 5 bytes encoded address and pressure data, and 1 byte <cr> char. [With CM=ON] 6 byte binary format; 1 byte header, 4 characters of encoded address and pressure data, 1 byte <cr> char.</p> <p>See P3 for typical reply. See the DO=P or DO=N commands for suspending readings from a P4 command.</p> <p>The reading rate is controlled by the I=, IC, and OP command settings.</p> <p style="text-align: center;">For RS-485 mode, the TO=C command must be set to transmit continuous readings.</p>						
<p>NOTE: (see Appendix A – PPT2 Binary Command Format for P3 and P4 Commands). Refer to page 7 for default decimal placement and significant digits.</p> <p style="text-align: center;">For RS-485 units, when the continuous transmit parameter is NOT active (is not set to TO=C), the P4 command sends only one reading.</p> <p style="text-align: center;">For RS-232 units, type a \$*ddIN to stop this command. The ‘\$’ character suspends the pressure readings while the *ddIN command disables the continuous output function. For RS-485 units when TO=C, type a *ddIN to stop this command.</p> <p>It is recommended that continuous broadcast be interrupted before sending other action or inquiry commands, especially when the PPT2 is broadcasting multiple readings per second. If a P4 command is sent in the midst of a PPT2 integration cycle, the first reading will not occur until the integration cycle is complete. This is most noticeable with long duration integration settings. If P4 continuous transmission is already active, subsequent P4 commands will be ignored and readings will continue to be transmitted at a rate determined by the I=, IC, and OP settings.</p>						
<p>EXAMPLES:</p> <p>Inquiry: *ddP4</p> <p style="padding-left: 40px;">Type: *ddIN To stop a single PPT2 from continuous pressure reading.</p> <p style="padding-left: 40px;">Type: \$*99IN To stop the continuous readings for all PPT2s on the bus.</p>						
<p>DIFFERENCES FROM LEGACY PPT: Default PPT2 implementation is 7 bytes versus 6 bytes for the PPT. Also, if a reading is not available, the only PPT2 response is xx??? where xx is the header character and 6 bits of address. The PPT also allows a response of xx_?? to indicate no reading is available</p>						

COMMAND CODE		COMMAND DESCRIPTION				
RS		Read Status				
Action Directing	Sequential Response with (90-99) address	Input or Output Type	Requires Write Enable	Terminates Continuous Commands	Can Write to EEPROM	Can Write to DAC
No	Before (5)	Out	No	No	No	No

DETAILS:
 The **Read Status** command is used to determine if an error, or warning, condition has been detected by the PPT2. The act of reading the **RS** command clears the error, or warning, indicators, except for memory checksum errors, which require two consecutive RS commands to clear.

If a sequential **RS** command is issued with the form: ***9dRS**, only addressed PPT2s with one or more error indications in the status register will respond; e.g., if the ***9dRS** command is returned with no response, then no errors exist.

If a sequential **RS** command is issued with the form: ***9dRS=**, then all sequentially addressed PPT2's respond in connected sequential order, whether an error exists or not. This form can be used to get a sequential "I am here and OK" response from all PPT2s.

NOTE:
 In the unlikely event of pressure correction memory, DAC correction memory, or configuration memory error, the temperature and pressure integration cycles will continue but readings will not be available. This can be overridden by executing two RS commands consecutively, which clears these error indications. Pressure, temperature and DAC readings will now be available, however, the readings may not be correct. The fourth error indicator (s) is prioritized in the order shown. When the **RS** command is issued with a group or global address (sequential mode), only PPT2s which have at least one error condition will respond. Replies are in sequential RS-232 bus loop connection order, followed by the return of the **RS** command.

At power-up, the internal PPT2 software checks to ensure that correction memory is properly loaded. If the transducer determines that correction memory has not been properly loaded, the RS response will be **RS=!!!!**.

EXAMPLES:

Inquiry: ***ddRS** **or** ***ddRS=**

Replies: **?ddRS=pqrs** (null address) **or** **#ddRS=pqrs** (assigned address)

Where:

- p = 0 No memory errors detected
- p = 1 Configuration memory checksum error
- p = 2 Pressure correction data checksum error
- p = 3 DAC correction data checksum error
- p = 4 Configuration memory and DAC correction data checksum error
- p = 5 Configuration memory and pressure correction data checksum error
- p = 6 Both pressure and DAC correction data checksum errors
- p = 7 Checksum errors in all three regions of memory
- p = 8 Reserved

- q = 0 No command error
- q = 1 Command error

- r = 0 No framing or parity errors
- r = 1 Framing error
- r = 2 Parity error (See **DO** command for additional information)
- r = 3 Both framing and parity errors

- s = 0 No temperature or pressure range errors
- s = > Over temperature condition
- s = < Under temperature condition
- s = + Over pressure condition (>1% over FS)
- s = - Under pressure condition (>1% under lower limit)
- s = W Watchdog timer interrupt occurred (see **OP** command description)
- s = R **IN=RESET** was executed.

A pressure-over-range error condition will occur when the applied pressure is greater than or equal to 1% of full scale (FS) above the FS limit. For example, if the pressure applied to a 20 psi unit is ≥ 20.200 psi, then an over range error condition is set. Similarly, an under range condition occurs when the applied pressure is greater than or equal to 1% FS below the minimum limit. If the temperature exceeds the operating temperature limits, the over/under temperature error flag is set. The temperature output reading will remain at the limits.

Out-of-range temperature has display precedence over out-of-range pressure, which has precedence over s=W or s=R (only one of which can be active at a time). The indication is cleared only if the condition no longer exists. If temperature out-of-range, pressure out-of-range, and s=W had all existed, then with successive RS commands, the first command would show the temperature condition, the second command would show the pressure condition, the third command would show s=W, and the fourth command would show no error. If there had been an over and an under-range condition, then the first RS inquiry reply will be "000+", the second will be "000-" and the third will be "0000"

The maximum pressure reading will flatten out somewhere between 1% and 5% beyond the FS limit with increasing pressure. This limit varies from device to device but will continue to display the out-of-range indicator ("!" in place of "=") until the pressure drops below the 1% over FS limit.

DIFFERENCES FROM LEGACY PPT:

PPT "control" memory is now PPT2 "configuration" memory.

PPT "characterization table memory" is now PPT2 "pressure correction data memory".

No parity is used in PPT2 configuration or PPT2 pressure correction table memory.

Microprocessor bandwidth and internal noise indicators have been removed.

RS=!!!! is a new response sequence and indicates improperly loaded correction memory. The PPT did not have a similar RS response.

The PPT User's Manual indicated: *"An *9dRS! or *9dRS!= echo response indicates one or more addressed PPTs had status data to transmit but did not have sufficient buffer space due to bus traffic. The RS command should be re-executed."*

This will not be an issue with the PPT2

COMMAND CODE		COMMAND DESCRIPTION				
S=		Serial Number				
Action Directing	Sequential Response with (90-99) address	Input or Output Type	Requires Write Enable	Terminates Continuous Commands	Can Write to EEPROM	Can Write to DAC
No	After (4)	Out	No	No	No	No
<p>DETAILS: The S serial number command reads the factory set PPT2 serial number.</p>						
<p>NOTE: If two PPT2 units on a RS-485 bus have the same ID then you can use the sequence below to re-assign ID numbers.</p>						
<p>EXAMPLES: Inquiry: *ddS=</p> <p><i>RS-485 type only</i> In multi-drop bus configuration only this command must be used to differentiate a PPT2 with a non-unique ID for a new ID (address) assignment. Command *99S=ssssssss, where ssssssss is the 8 character serial number of the PPT2 (in this case the leading zeros of the serial number must be used because the identification match is made on all 8 ASCII characters- not the decimal value of the serial number), identifies the PPT2 for identification address assignment. The address assignment is then performed by a *99IDnn command, where nn is the address.</p> <p>Action: *99WE *99S=ssssssss (this allows the PPT2 to accept the next *99ID command) *99WE *99ID=nn (this assigns the PPT2 #ssssssss the ID number 'nn')</p> <p>Where: ssssssss is the PPT2 serial number with sufficient leading zeros to provide 8 characters.</p>						
<p>DIFFERENCES FROM LEGACY PPT: PPT also had parity bits stored with the S= value. No S= parity will be stored or checked in the PPT2.</p>						

COMMAND CODE		COMMAND DESCRIPTION				
SP		Store Parameters in EEPROM				
Action Directing	Sequential Response with (90-99) address	Input or Output Type	Requires Write Enable	Terminates Continuous Commands	Can Write to EEPROM	Can Write to DAC
Yes	No	In	Yes	No	All	No
<p>DETAILS: The Store Parameters command causes all control parameter(s) to be stored in the static memory (EEPROM) so they are available after power is cycled. Only changes are updated, and if an update is made, the configuration parameter memory checksum is also automatically recalculated and stored.</p>						
<p>NOTE: This command will not work when a *ddWE=RAM continuous write enable is active. It must have a singular write enable (*ddWE) command preceding it. To ensure the integrity of stored values, SP=ALL is only valid at transducer temperatures of -40°C or greater, per T1/T2 temperature readings. At temperatures < -40°C, an SP=ALL request will be rejected and a command error indicated in the RS response.</p>						
<p>EXAMPLES: Action: *ddWE *ddSP= ALL Writes all parameters to EEPROM.</p>						
<p>DIFFERENCES FROM LEGACY PPT: Only differences are the size, location, and contents of the EEPROM storage. In PPT, SP=A, SP=AL, and SP=ALL are all valid variations of the Store Parameters command. In the PPT2, only SP=ALL is valid.</p>						

COMMAND CODE		COMMAND DESCRIPTION								
T=		Set Tare Value (gauge units only)								
Action Directing	Sequential Response with (90-99) address	Input or Output Type	Requires Write Enable	Terminates Continuous Commands	Can Write to EEPROM	Can Write to DAC				
Yes	After (4)	Both	Yes (6)	No	Yes (9)	Yes				
<p>DETAILS: The Tare command allows the user to input a tare (zero offset) value, and is applicable only to gauge (psig) PPT2 types. This command has two forms. 1) Use the currently applied pressure to zero the PPT2 (SET), or 2) The user may supply a zero set point value (<i>TareValue</i>) in terms of a %FS pressure range. If there is an input value limit error, the command error flag in the RS command will be set and no change will occur. A pressure over or under range error will be set (see RS) and the "!" will appear in the reading if the applied pressure exceeds the FS range, or falls below zero, by 1%FS. (Default:T=0.0000)</p> <p>What is a tare? Setting the tare is similar to setting an offset pressure. An example would be weighing an empty container before filling it. A tare is set to offset the weight of the container so that it is not included in the final weight.</p>										
<p>NOTE: Tare affects both the digital and analog outputs.</p>										
<p>EXAMPLES: Inquiry: *ddT=</p> <table style="width: 100%; border: none;"> <tr> <td style="padding-right: 20px;">Action: *ddWE</td> <td style="padding-right: 20px;">EEPROM Store: *ddWE</td> </tr> <tr> <td style="padding-right: 20px;">*ddT={SET <i>TareValue</i>}</td> <td>*ddSP=ALL</td> </tr> </table> <p>SET Set tare value to current pressure present at the PPT2 pressure port.</p> <p><i>TareValue</i> -.02 to 1.02 (%FS) <i>TareValue</i> must be a decimal number between 1.02 and -0.02. This corresponds to a tare value that is between 2% above FS and 2% below zero, for gauge units only. Up to four digits may be supplied following the decimal point. For example, to tare a 100 psig PPT2 to 1/1000 psi (=0.01%) below its untared zero point, the command *ddT=-0.01 or *ddT=-.01 would be used. It is advisable to confirm the setting by executing a *ddT= command after the setting is established. The confirmation reply is always in terms of a percentage of full range (10%FS = 0.1000). If an attempt is made to establish a tare value outside of the allowed range, the tare update will not occur and a command error (see RS) will occur. When the T= command is legally executed, it turns the tare control to ON. See the TC command for subsequent disabling and enabling of the user supplied tare.</p>							Action: *ddWE	EEPROM Store: *ddWE	*ddT={SET <i>TareValue</i> }	*ddSP=ALL
Action: *ddWE	EEPROM Store: *ddWE									
*ddT={SET <i>TareValue</i> }	*ddSP=ALL									
<p>DIFFERENCES FROM LEGACY PPT: Tare only impacts the digital output on the PPT. Both digital and analog are impacted by Tare in the PPT2.</p>										

COMMAND CODE		COMMAND DESCRIPTION				
T1		Sensor Temperature, Single, °C				
Action Directing	Sequential Response with (90-99) address	Input or Output Type	Requires Write Enable	Terminates Continuous Commands	Can Write to EEPROM	Can Write to DAC
No	Before (5)	Out	No	No	No	No
<p>DETAILS: The T1 command requests a single temperature reading in degrees Celsius. The reading resolution is 0.1 degrees C. Each T1 reading is the average of 64 corrected temperature values.</p>						
<p>NOTE: When IC=0, corrected sensor temperature values are generally created every 1 millisecond resulting in a new T1 reading every 64 milliseconds. Immediately after power-up or IN=RESET, the PPT2 may respond with #ddCT=.. to indicate a new T1 reading is not yet available. When IC≠0, the delay for the first valid reading may be larger. For example, if IC=255 and I=R1000, a new T1 reading may not be available for approximately 16 seconds.</p>						
<p>EXAMPLES:</p> <p>Inquiry: *ddT1</p>						
<p>DIFFERENCES FROM LEGACY PPT: PPT also had T3 and T4 for °F. PPT2 will not support T3 and T4. PPT description indicated the possibility of a group or global command echo of *9dT1! indicating that RS-232 buffer space was not available for one or more of the addressed PPTs. This will not be an issue with the PPT2.</p>						

COMMAND CODE		COMMAND DESCRIPTION				
T2		Sensor Temperature, Continuous, °C				
Action Directing	Sequential Response with (90-99) address	Input or Output Type	Requires Write Enable	Terminates Continuous Commands	Can Write to EEPROM	Can Write to DAC
No (3)	After	Out	No	Yes (8)	No	No
<p>DETAILS: The T2 command requests continuous temperature readings in degrees Celsius. The reading resolution is 0.1 degrees C. Each T2 reading is the average of 64 corrected temperature values. The reading rate for T2 is approximately 15 readings per second.</p>						
<p>NOTE: For RS-485 units, when the continuous transmit parameter is NOT active (is not set to TO=C), the T2 command sends only <i>one</i> reading. For RS-232 units, type a *\$*99IN to stop this command. The '\$' character suspends the readings while the *99IN command disables the continuous output It is recommended that continuous broadcast be interrupted before sending other action or inquiry commands. See also the notes for the T1 command.</p>						
<p>EXAMPLES: Inquiry: *ddT2 Type: *\$*99IN To stop the continuous temperature reading command.</p>						
<p>DIFFERENCES FROM LEGACY PPT: PPT also had T3 and T4 for °F. PPT2 will not support T3 and T4.</p>						

COMMAND CODE		COMMAND DESCRIPTION				
U=		User Supplied Display Units				
Action Directing	Sequential Response with (90-99) address	Input or Output Type	Requires Write Enable	Terminates Continuous Commands	Can Write to EEPROM	Can Write to DAC
Yes	After (4)	Both	Yes (6)	No	Yes (9)	No
DETAILS: The User supplied display units command allows the user to enter units of measure for the PPT2. The value entered for this command is multiplied by the actual pressure in psi to get the user defined units. For example, if *ddU=15.0<cr> , then the compensated pressure output values will be 15 times the actual psi value. This function (multiplier) is activated by executing the *ddDU=USER<cr> command. If there is an input error, then the command error flag in the RS command will be set and no change will occur. Default: 1.0000						
NOTE:						
EXAMPLES: Inquiry: *ddU= <div style="display: flex; justify-content: space-between; margin-left: 40px;"> <div style="text-align: left;"> Action: *ddWE *ddU=UserValue </div> <div style="text-align: right;"> EEPROM Store: *ddWE *ddSP=ALL </div> </div> <p style="margin-left: 40px;"><i>UserValue</i> Must be a value between 0.001 and 999.99. It is advisable to confirm the setting by executing a *ddU=<cr> command after the U= setting is established. The user supplied display function is activated by executing the *ddDU=USER<cr> command.</p>						
DIFFERENCES FROM LEGACY PPT: No difference from PPT implementation.						

COMMAND CODE		COMMAND DESCRIPTION				
V=		Version Number				
Action Directing	Sequential Response with (90-99) address	Input or Output Type	Requires Write Enable	Terminates Continuous Commands	Can Write to EEPROM	Can Write to DAC
No	After (4)	Out	No	No	No	No
<p>DETAILS: The V version number command transmits the factory-set software version number.</p>						
<p>NOTE:</p>						
<p>EXAMPLES: Inquiry: *ddV= Reply: #01V=04.44S2V</p> <p style="margin-left: 40px;"> 04.44 Software version number S PPT2 Type S: Standard PPT2 2 or 4 Digital Output 2: RS-232 4: RS-485 V Analog Output V: 0-5 volt </p>						
<p>DIFFERENCES FROM LEGACY PPT: No difference from PPT implementation.</p>						

COMMAND CODE		COMMAND DESCRIPTION				
W=		Width of Pressure Window				
Action Directing	Sequential Response with (90-99) address	Input or Output Type	Requires Write Enable	Terminates Continuous Commands	Can Write to EEPROM	Can Write to DAC
Yes	After (4)	Both	Yes (6)	No	Yes (9)	Yes (11)

DETAILS:

Set the width, or span, of the pressure window to a smaller range to fill the analog output voltage limits. This command sets a pressure window value, or span, from 0.05 to 100% of full scale in increments of 0.05%FS. This command is used with the **O=**, **L=**, and **H=** commands to customize the size of the PPT2 analog pressure window and analog output voltage. If there is an input error, then the command error flag in the **RS** command will be set and no change will occur. This command is enabled by the **AN** command. See Figure below for command illustration with **O=1200** and **W=400**, and a 20 psi PPT2 (Default: **W=2000**)

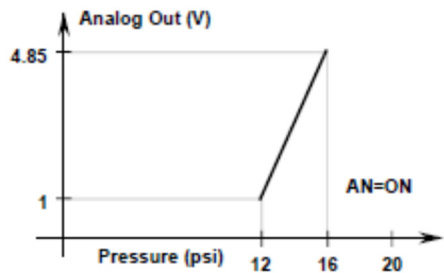

For example the figure above shows when **L=0** and **H=5000**, if a 20 psia (or 20 psig) unit had the pressure window width set to **W=400**, then the 0 to 5 volt analog output span would correspond to 0 to 4 psi (20% of 20 psi). Use the **O=** command (**O=1200**) to offset the pressure window by 12 psi. Now the analog output values range from 0 volt=12 psi up to 5 volt=16 psi.

If a 20 psid unit had the pressure window width set to **W=1200**, then the pressure window would be 24 psi (60% of 40 psi). The analog 0V output would begin at -20 psi, cross 2.5V at -8 psi, and output 5V at 4 psi. If a window offset of **O=400** was set, then the analog 0V output would begin at -12 psi, cross 2.5V at 0 psi, and output 5V at 12 psi. When setting **W=1200** and the pre-existing **O=** value is > 800, the **O=** value is automatically adjusted to 800.

NOTE:

The sum of **W=** and **O=** values cannot exceed 2000. If the existing **O=** value + newly selected **W=** value > 2000, the **O=** value will automatically be adjusted such that **O=** plus **W=** equals 2000.

EXAMPLES:

Inquiry: ***ddW=**

Action: ***ddWE** EEPROM Store: ***ddWE**
***ddW=pppp** | **S** ***ddSP=ALL**

pppp **0 - 2000** This number is a 0.05% percent (%) multiplier of the full scale pressure that sets the pressure span across the analog output range. It can also be thought of as scaling, or shrinking, the pressure window to fill the output voltage range. Requesting **W=0** will set **W=2000**, full span. A **W=** entry greater than 2000 will set **W=2000**.

S This enables the analog output setpoint. The setpoint trip voltage is controlled by the **O=** command. The setpoint null, or hysteresis, is controlled by the **DS** command. The setpoint off voltage is controlled by the **L=** command and the on voltage is controlled by the **H=** command. See Appendix C for additional information.

DIFFERENCES FROM LEGACY PPT:

PPT only allowed settings of 0-100, each count representing 1%FS.

COMMAND CODE		COMMAND DESCRIPTION				
WE		Write Enable to EEPROM or RAM				
Action Directing	Sequential Response with (90-99) address	Input or Output Type	Requires Write Enable	Terminates Continuous Commands	Can Write to EEPROM	Can Write to DAC
Yes	No	In	No	No	No	No
<p>DETAILS: The Write Enable command enables a static memory write or a RAM write operation. It is used as a safeguard to prevent erroneous command sequences from changing the PPT2 configuration. A *ddWE command must immediately precede the SP command when storing information in static memory. The *ddWE command must also immediately precede any command that changes the configuration parameters in the RAM. When manually making multiple configuration changes, *ddWE=RAM command form may be used to permanently enable RAM updates until the next *ddWE or *ddWE=OFF command is executed</p>						
<p>NOTE: The *ddWE command remains active until the next '*' followed by a <cr> is received, or passes through. The only valid user parameters past the WE are "=RAM" and "=OFF". All other parameters will generate a command error.</p>						
<p>EXAMPLES: Action: *ddWE This enables the next command to write to the RAM or EEPROM, and also disables the *ddWE=RAM condition after the next command is received.</p> <p> Action: *ddWE=RAM This provides a permanent RAM write enable. All commands following a *ddWE=RAM will be stored in RAM. A *ddWE command will disable, or deactivate, this permanent RAM write enable. The *ddWE=RAM command will not allow the SP command to write to EEPROM.</p> <p> Action: *ddWE=OFF This immediately disables the *ddWE=RAM condition.</p>						
<p>DIFFERENCES FROM LEGACY PPT: Unlike the PPT, incorrect characters following the WE will result in a command error. For example, the PPT would reject *01WEjkm and yet not report a command error. The PPT2 will both reject the improper command and report a command error.</p>						

COMMAND CODE		COMMAND DESCRIPTION				
X=		Slope 1 – User Compensation Control				
Action Directing	Sequential Response with (90-99) address	Input or Output Type	Requires Write Enable	Terminates Continuous Commands	Can Write to EEPROM	Can Write to DAC
Yes	After (4)	Both	Yes (6)	No	Yes (9)	Yes

DETAILS:
 The user can adjust the pressure vs. output curve using the **X=**, **Y=**, and **Z=** commands. The **X=** command adjusts the slope of the pressure output curve for positive pressures. This applies to all absolute and gauge devices and modifies the positive full scale slope of differential PPT2s. The algorithm for the **X=** slope adjustment is shown below. If there is an input error, then the command error flag in the **RS** command will be set and no change will occur. See Figure below for command illustration. (Default: **X=0**)

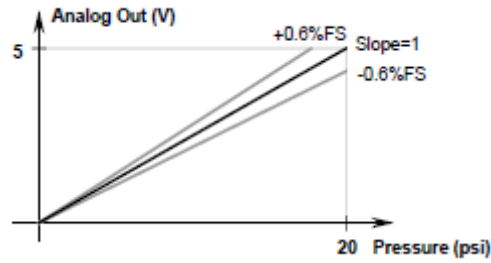

NOTE:
 Offset errors should be corrected with the **Z=** command before applying any **X=** correction. When changing the **X=** value, the correction may not be apparent until the first full integration cycle following the request.

EXAMPLES:
 Inquiry: *dd**X=**
 Action: *dd**WE** EEPROM Store: *dd**WE**
 *dd**X=ppp** *dd**SP=ALL**
ppp **0 to ±300** This number adjusts the pressure reading by multiplying it by 0.00002 and scaling the slope of the pressure reading before output.
 Pressure Output = [1 + (pp x 0.00002)] x Pressure Reading

DIFFERENCES FROM LEGACY PPT:
 PPT implementation was 0 to ±120 in 0.00005 increments: Pressure Output = [1 + (pp x 0.00005)] x Pressure

COMMAND CODE		COMMAND DESCRIPTION												
Z=		Offset – User Compensation Control												
Action Directing	Sequential Response with (90-99) address	Input or Output Type	Requires Write Enable	Terminates Continuous Commands	Can Write to EEPROM	Can Write to DAC								
Yes	After (4)	Both	Yes (6)	No	Yes (9)	No								
<p>DETAILS: The user can adjust the pressure vs. output curve using the X=, Y=, and Z= commands. The Z= command adjusts the offset of the pressure output curve. This applies to all absolute, gauge, and differential PPT2s. The algorithm for the Z= adjustment is shown below. If non-zero, use the Customized Full Scale Range setting (F=) for the “Full Scale” in the equation. If F=0, use the factory-set M= full scale value. For differential units use one-half the range (FS=10 for a 10psid). For a gauge unit, a zero offset null can be set by removing pressure and executing a Z=CAL command. For a differential unit, a zero offset null can be set by applying equal pressure to both ports and executing the Z=CAL command. Z=CAL is not applicable for absolute units. If there is an input error, then the command error flag in the RS command will be set and no change will occur. See Figure X.X for command illustration. (Default: Z=0)</p>														
<p>NOTE: When changing Z= settings, deadband should be turned off (DS=0) to ensure Z= adjustments are properly applied. Changes to the user F= value will cause any existing Z= value to be recalculated; up to the limit of valid Z= values ($\pm 60,000$) where $(Z = \text{new}) = (Z = \text{old}) \times (\text{Full Scale Old} / \text{Full Scale New})$. Example, if 20 psia PPT2 has Z=10 and F= is set to 15 PSIA, Z= is recalculated as: $(Z = \text{new}) = 10 \times (20/15) = 13$. When changing the Z= value, the correction may not be apparent until the first full integration cycle following the request.</p>														
<p>EXAMPLES: Inquiry: *ddZ=</p> <table border="0"> <tr> <td style="padding-right: 20px;">Action:</td> <td style="padding-right: 20px;">*ddWE</td> <td style="padding-right: 20px;">EEPROM Store:</td> <td>*ddWE</td> </tr> <tr> <td></td> <td>*ddZ={ppp CAL}</td> <td></td> <td>*ddSP=ALL</td> </tr> </table> <p>ppp 0 to ± 60000 This number adjusts the pressure reading by adding ($ppp \times 0.0001\%$ FS). $\text{Pressure Output} = [(ppp \times 0.000001) \times (\text{Full Scale})] + \text{Pressure Reading}$</p> <p>CAL Sets the zero pressure condition to zero output. Offset is calculated and stored, then applied to all readings thereafter. Set Z=0 to cancel. The range of correction for the CAL command is the same as ppp described above. If the correction is out of range, then the Z= parameter will not be set and a command error will be indicated in the RS command response. Applicable for gauge and differential units only.</p>							Action:	*ddWE	EEPROM Store:	*ddWE		*ddZ={ppp CAL}		*ddSP=ALL
Action:	*ddWE	EEPROM Store:	*ddWE											
	*ddZ={ppp CAL}		*ddSP=ALL											
<p>DIFFERENCES FROM LEGACY PPT: PPT implementation was 0 to ± 120 in 0.005%FS increments.</p>														

COMMAND CODE		COMMAND DESCRIPTION				
\$		Suspend Continuous Readings				
Action Directing	Sequential Response with (90-99) address	Input or Output Type	Requires Write Enable	Terminates Continuous Commands	Can Write to EEPROM	Can Write to DAC
<p>DETAILS: This is not actually a command but a special command header character. During a continuous pressure reading command, P2 or P4 in RS-232 ring configuration a '\$' by itself will temporarily stop, or suspend, transmission. Pressure readings will continue to be taken at the configured rate but will not be transmitted on the RS-232 outputs. This allows for manual entry of a command when continuous readings would be filling the display. Pressure reading transmission will resume when the <cr> carriage return (ENTER key) is pressed.</p>						
<p>NOTE: Under some conditions it is possible to enter a command that will not cause continuous readings to resume after entering the <cr> character, in which case a second <cr> will cause the continuous readings to resume.</p>						
<p>EXAMPLES:</p> <p>Example:*ddP2 (<i>Start continuous pressure readings</i>)</p> <p style="padding-left: 40px;">\$*ddV= (<i>Suspend continuous pressure readings to read version number</i>) (<i>Resume continuous pressure reading after the V= reply</i>)</p>						
<p>DIFFERENCES FROM LEGACY PPT: No difference from PPT implementation.</p>						

6.0 Electrical Connections

Pin	Name
A	RS-232 (TD) or RS-485 (B)
B	RS-232 (RD) or RS-485 (A)
C	Case Ground
D	Common Ground
E	DC Power Input
F	Analog Output

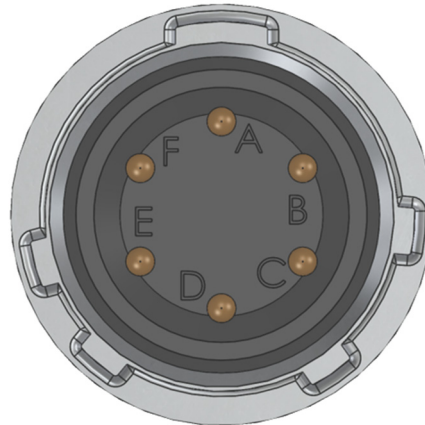

The generic P/N for PPT2 mating connector is “MS3116F10-6S”

Examples:

- Amphenol P/N PT06A10-6S, Newark Stock no. 93F9344
- Amphenol P/N PT06A10-6S (005), Newark Stock no. 09J8978
- ITT Cannon P/N MS3116F10-6S Newark Stock no. 93F3377

Figure 6.1 – PPT2 Electrical Connector Pin Assignments

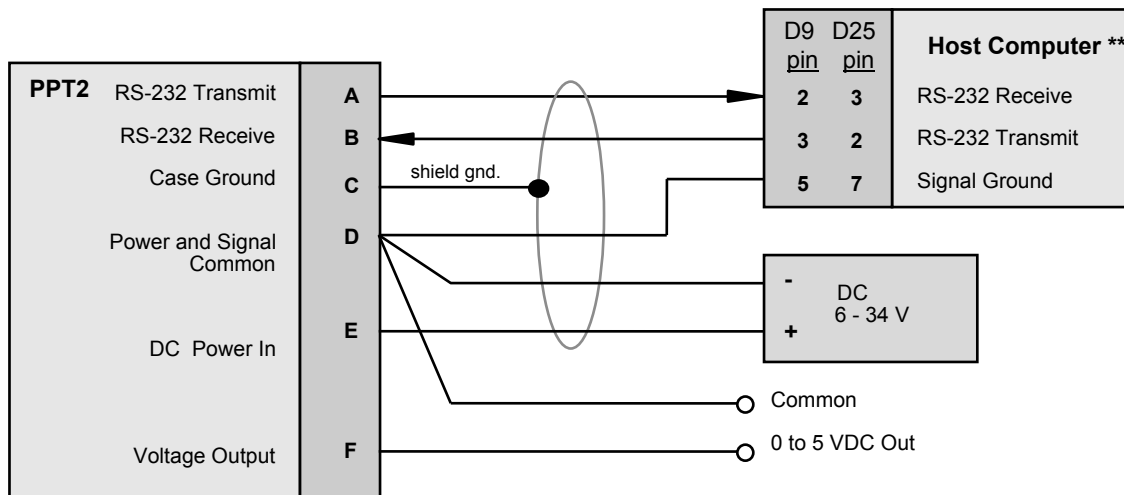

** Host computers without a COM port may require a USB-to-RS232 or similar adapter.

Figure 6.2 – Connection for RS-232 Operation and Analog Output

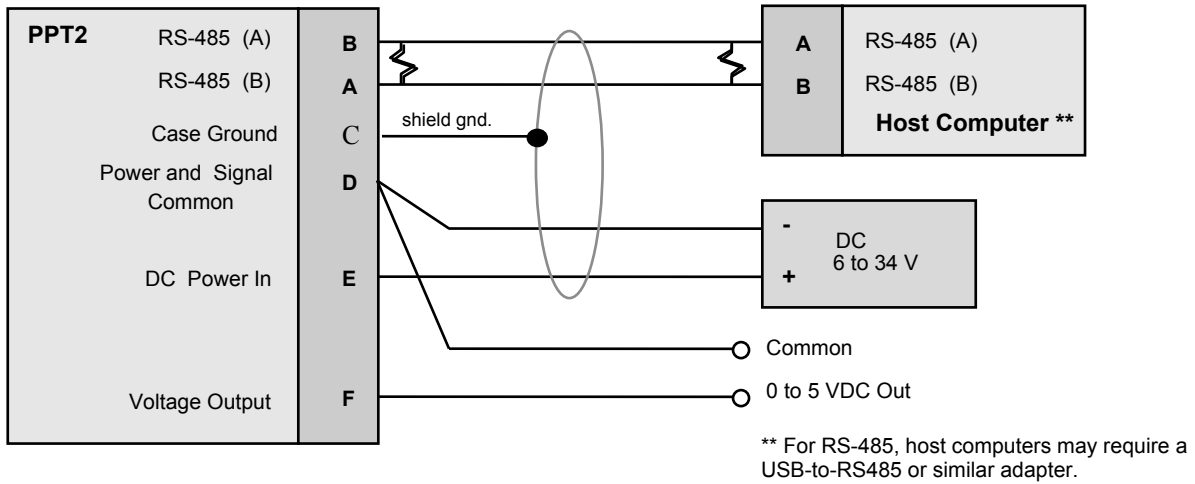

Figure 6.3 – Connection for RS-485 Operation and Analog Output

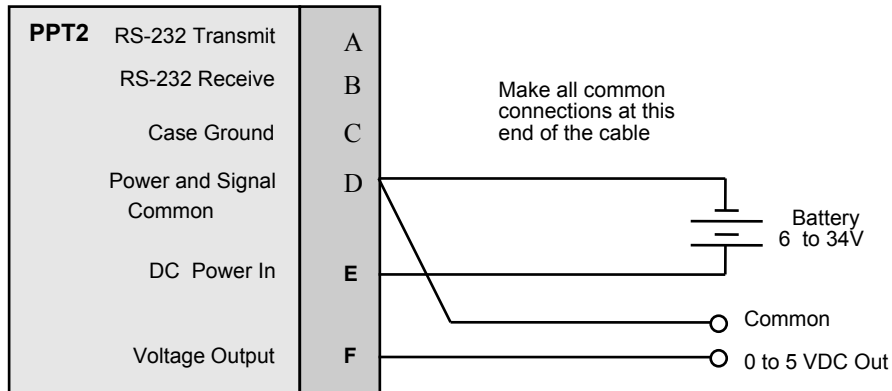

Figure 6.4 – Connection for Analog Output and Battery Operation

7.0 Installation Recommendations, Cautions and Materials of Construction

7.1 RECOMMENDATIONS

1. PPT2 media compatibility is non-condensing, non-corrosive, non-combustible gases. To ensure the best transducer performance it is strongly suggested that PPT2 transducers and associated plumbing be oriented to prevent accumulation of debris or condensation in the pressure ports.
2. PPT2 port P1 should be shielded from direct light due to a strong photoelectric effect on the sense element.
3. For digital communications, cable length should be appropriate for the chosen standard: RS-232 or RS-485.

For RS-232, the commonly published maximum cable length is 50 feet. However, with high quality cable and lower bit rates, the maximum reliable cable length may be much longer.

For RS-485, the commonly published maximum cable length is 4000 feet. However, with high quality cable and lower bit rates, the maximum reliable cable length may be much longer.

4. The PPT2 was tested to show compliance with European Electromagnetic Compatibility directive 2004/108/EC.
To ensure the best performance in an EMI environment, cabling should be shielded twisted-pair with 360° shield termination at the mating connector back-shell. In addition, the PPT2 housing should be electrically grounded to a suitable chassis or airframe.
5. Mounting holes in the PPT2 are threaded for 4-40 UNC-2B screws, to a depth of .425 inches. When mounting the PPT2 to a plate, the recommended mounting hole pattern is shown below (upright orientation):

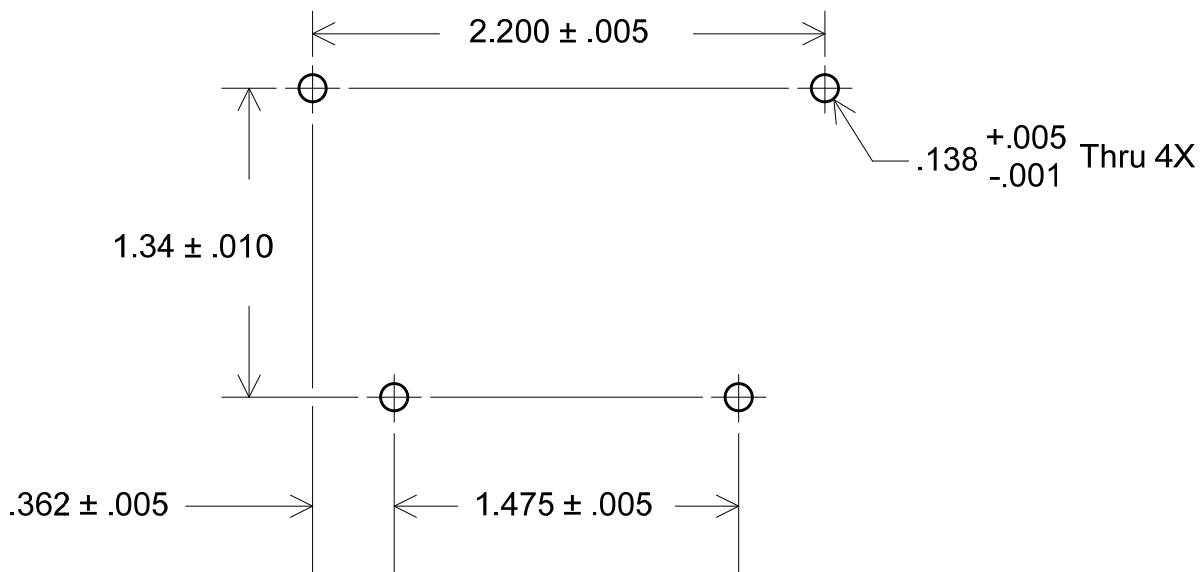

To install the PPT2 into legacy PPT applications, please consult Honeywell Application Note AN106, "Mechanically Mounting the PPT2 in Legacy PPT Applications", found at: www.pressuresensing.com.

7.2 CAUTIONS

1. The PPT2 is an ESD (electrostatic discharge) sensitive device. Damage may occur when subjected to high energy ESD. Proper ESD precautions should be taken to avoid performance degradation or loss of functionality.
2. The PPT2 is an EOS (electrical overstress) sensitive device. Damage may occur when subjected to EOS. Do not exceed specified ratings to avoid performance degradation or loss of functionality.

7.3 MATERIALS OF CONSTRUCTION

The PPT2 housing and cover are machined from 6061-T6/651 aluminum and plated with high phosphorus (10 – 13%) nickel, 0.0003 – 0.0005 inches thick. The cover is attached using Creative Materials silver-filled epoxy adhesive 118-15C. User-selected pressure fittings are either UNS C36000 H02 free cutting brass or UNS S30300/31600 stainless steel. As indicated in the PPT2 datasheet, internal sensor materials are compatible with non-condensing, non-corrosive and non-combustible gases.

8.0 Firmware Errata

8.1 Known issues with current PPT2 firmware revision 4.45SxV

As compared with the legacy PPT, absolute pressure PPT2's configured with OP=R (remove header characters), will insert an extra leading space character (0x20) in the P1/P2 response. This issue is not present on gauge or differential pressure PPT2's.

Appendix A: PPT2 Binary Command Format for P3 and P4 Commands:

For CM=ON (compatible with existing PPT)

- Binary format reply consists of 1 byte header character, 4 characters of encoded data, 1 byte optional cyclic checksum, 1 byte <cr> character.
- Error condition in the Header Character is **yes**, if over/under temperature or pressure error bit is set in the RS Command. Sign of Pressure data is also encoded in the header character. See Table 1 below.
- The 4 byte data value contains the device address and pressure reading. The most significant bit of each data character is a parity bit. The next most significant bit of each data character is either a 1 or 0 required to make the resultant byte a printable character. The six least significant bits of each data character are used for the device address and pressure reading.
- Sign bit is also encoded in binary value if OP=S.

{hhh<cr>

'{' represents the header character
'hhh' represents the 4 bytes of data.

Header Characters	Assigned Address	Error Condition	Data Sign	Alternate Hdr. RS-485 only (1)
{	Yes	No	+	DC1 (ctrl Q)
}	Yes	No	-	DC2 (ctrl R)
!	Yes	Yes	+	DC3 (ctrl S)
@	Yes	Yes	-	DC4 (ctrl T)
^	Null	No	+	none
&	Null	No	-	none
	Null	Yes	+	none
%	Null	Yes	-	none

Table 1 – Header Description for Binary Format Pressure Readings

The device ID and the pressure reading can be read by combining the 6 least significant bits of each of the four 'h' characters, which result in 24 bits of information. The first 7 bits represent the device address in binary form (00 through 89 decimal). The next 17 bits represent the pressure reading and can be configured in the signed form or the extended form by using the OP=S command. The 24 bit binary forms are:

Extended: 7 bit binary device address 17 bit binary pressure data
Signed: 7 bit binary device address sign bit + 16 bit binary pressure data
Example binary reply: {#@#16<cr>

Refer to Table 1 for the header character '{' definition. The sign of this pressure value is determined by the header character. The next 4 characters, '@#16', contain the encoded device address and the temperature compensated pressure reading. For this example, the extended form is used so that the pressure data is represented as a 17 bit binary value.

Using standard ASCII codes, convert each of the 4 byte characters into the binary value equivalent. The bold portion of each character below represents the 6 least significant bits. (Both parity is off and OP=N)

'@' = 01 **000000**
'#' = 00 **100011**
'1' = 00 **110001**
'6' = 00 **110110**

Using the least significant (LS) 6 bits of each of the 4 data bytes, regroup the binary numbers into the 7 bit binary device address and 17 bit binary pressure data, which produces the 24 bit string:

000000 100011 110001 110110 = @!16 least significant 6 bits of each byte

0000001 00011110001110110 = (device ID=01) and (pressure = 15478)

The binary format reply indicates the device address is ID=01 and the pressure reading is 15478. Now, the decimal point position for the pressure reading must be determined. The decimal place is in the same position as when it reads a P1 pressure command, (see page 14 for decimal position information.) So, if this is a 20 psig device reading in inches water column (DU=INWC) then there are 2 decimal places. The final reading from the binary format will be 154.78 inH2O. The header character for this binary reply was '{' which indicates a positive pressure value.

For CM=OFF (PPT2 default, extra resolution)

- Binary format reply consists of 1 byte header character, 5 characters of encoded data, 1 byte optional cyclic checksum, 1 byte <cr> character.
- Error condition in the Header Character is **yes**, if over/under temperature or pressure error bit is set in the RS Command. Sign of Pressure data is also encoded in the header character. See table 1 below.
- The 5 byte data value contains the device address and pressure reading. The most significant bit of each data character is a parity bit. The next most significant bit of each data character is either a 1 or 0 required to make the resultant byte a printable character. The six least significant bits of each data character are used for the device address and pressure reading.
- Sign bit is also encoded in binary value if OP=S.

{hhhhh<cr>

'{' represents the header character
'hhhhh' represents the 5 bytes of data.

The device ID and the pressure reading can be read by combining the 6 least significant bits of each of the five 'h' characters, which result in 30 bits of information. The first 7 bits represent the device address in binary form (00 through 89 decimal). The next 23 bits represent the pressure reading and can be configured in the signed form (OP=S) or the extended form (OP=E) . The 30 bit binary forms are:

Extended:	7 bit binary device address	23 bit binary pressure data
Signed:	7 bit binary device address	sign bit + 22 bit binary pressure data

Example binary reply: {@!160<cr>

Refer to Table 1 for the header character '{' definition. The sign of this pressure value is determined by the header character. The next 4 characters, '@!160', contain the encoded device address and the temperature compensated pressure reading. For this example, the extended form is used so that the pressure data is represented as a 23 bit binary value.

Using standard ASCII codes, convert each of the 5 byte characters into the binary value equivalent. The bold portion of each character below represents the 6 least significant bits. (Both parity is off and OP=N)

'@' = 01 **000000**
'!' = 00 **100001**
'1' = 00 **110001**
'6' = 00 **110110**
'0' = 00 **110000**

Using the least significant (LS) 6 bits of each of the 5 data bytes, regroup the binary numbers into the 7 bit binary device address and 23 bit binary pressure data, which produces the 30 bit string:

000000 100001 110001 110110 110000 = @!160 least significant 6 bits of each byte

0000001 00001110001110110110000 = (device ID=01) and (pressure = 466352)

The binary format reply indicates the device address is ID=01 and the pressure reading is 466352. Now, the decimal point position for the pressure reading must be determined. The decimal place is in the same position as when it reads a P1 pressure command, (see page 14 for decimal position information.) So, if this is a 100 psig device reading in meters of water column (DU=MWC) then there are 4 digits to the right of the decimal place (with CM=OFF). The final reading from the binary format will be 46.6352 mWC. The header character for this binary reply was '{', indicating a positive pressure value.

Appendix B: ASCII Table

DEC	HEX	ASCII	KEY	DEC	HEX	ASCII	DEC	HEX	ASCII	DEC	HEX	ASCII
0	00	NUL	ctrl @	32	20	SP	64	40	@	96	60	'
1	01	SOH	ctrl A	33	21	!	65	41	A	97	61	a
2	02	STX	ctrl B	34	22	"	66	42	B	98	62	b
3	03	ETX	ctrl C	35	23	#	67	43	C	99	63	c
4	04	EOT	ctrl D	36	24	\$	68	44	D	100	64	d
5	05	ENQ	ctrl E	37	25	%	69	45	E	101	65	e
6	06	ACK	ctrl F	38	26	&	70	46	F	102	66	f
7	07	BEL	ctrl G	39	27	'	71	47	G	103	67	g
8	08	BS	ctrl H	40	28	(72	48	H	104	68	h
9	09	HT	ctrl I	41	29)	73	49	I	105	69	i
10	0A	LF	ctrl J	42	2A	*	74	4A	J	106	6A	j
11	0B	VT	ctrl K	43	2B	+	75	4B	K	107	6B	k
12	0C	FF	ctrl L	44	2C	,	76	4C	L	108	6C	l
13	0D	<cr>	ctrl M	45	2D	-	77	4D	M	109	6D	m
14	0E	SO	ctrl N	46	2E	.	78	4E	N	110	6E	n
15	0F	SI	ctrl O	47	2F	/	79	4F	O	111	6F	o
16	10	DLE	ctrl P	48	30	0	80	50	P	112	70	p
17	11	DC1	ctrl Q	49	31	1	81	51	Q	113	71	q
18	12	DC2	ctrl R	50	32	2	82	52	R	114	72	r
19	13	DC3	ctrl S	51	33	3	83	53	S	115	73	s
20	14	DC4	ctrl T	52	34	4	84	54	T	116	74	t
21	15	NAK	ctrl U	53	35	5	85	55	U	117	75	u
22	16	SYN	ctrl V	54	36	6	86	56	V	118	76	v
23	17	ETB	ctrl W	55	37	7	87	57	W	119	77	w
24	18	CAN	ctrl X	56	38	8	88	58	X	120	78	x
25	19	EM	ctrl Y	57	39	9	89	59	Y	121	79	y
26	1A	SUB	ctrl Z	58	3A	:	90	5A	Z	122	7A	z
27	1B	ESC	ctrl [59	3B	;	91	5B	[123	7B	{
28	1C	FS	ctrl \	60	3C	<	92	5C	\	124	7C	
29	1D	GS	ctrl]	61	3D	=	93	5D]	125	7D	}
30	1E	RS	ctrl ^	62	3E	>	94	5E	^	126	7E	~
31	1F	US	ctrl _	63	3F	?	95	5F	_	127	7F	DEL

* ASCII – American Standard for Coded Information Interchange

Appendix C: Setting an Analog Pressure Set Point

Another feature of the PPT2 is the ability to program an analog pressure set point that triggers the analog output from the low voltage setting (L=) to the high voltage setting (H=) using the W= and O= commands. These outputs can be used to activate alarms or lights based on pressure conditions. The set point can be changed via the digital serial interface.

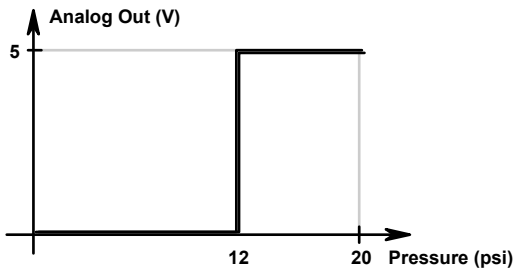

Figure C.1 - Pressure Set Point Set

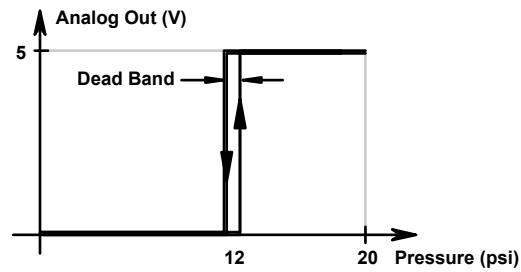

Figure C.2 - Deadband on Set Point

If a set point from a 20 psig unit was desired whenever the pressure equals, or exceeds 12 psi, then set O=1200 ($1200 \times 0.05\% = 60\%$, 12 psi = 60% of 20 psi FS) and W=S (for setpoint). Figure C.1 illustrates the pressure vs. voltage response curve. The output will change to 5 volts at 12 psi. The output levels can be changed by using the L= and H= commands. If the unit were a 20 psid (differential), then the commands O=1600 ($1600 \times 0.05\% = 80\%$, 32 psi = 80% of 40 psi FS) and W=S are used. The difference is that the offset (O=) is referenced to the minimum pressure value, which is -20 psi for this differential unit. If the pressure signal has some noise in it, then a deadband should be added to the set point. For a 20psig unit, setting DS=60 will put a ± 0.06 psi deadband around the 12 psi set point. That is, the output will switch from 0 to 5V at 12.06 psi for increasing pressures and switch from 5 to 0V at 11.94 psi for decreasing pressures. The I= command can be used to filter, (by increasing the integration time), any noise on the pressure signal.

Appendix D: RAM Initialization

PPT2 RAM Initialization

