

Product Description

SmartRunway® and SmartLanding®

functions of the

Enhanced Ground Proximity Warning System

Table of Contents

1. PURPOSE AND APPLICABILITY ----- 4

2. SYSTEM OVERVIEW ----- 4

2.1 Runway Awareness and Advisory System (RAAS) ----- 6

2.2 Stabilized Approach Monitor ----- 7

2.3 Altimeter Monitor ----- 8

2.4 Takeoff Flap Configuration Monitor ----- 9

2.5 Long Landing Monitor ----- 9

3. GENERAL CHARACTERISTICS ----- 10

3.1 Aural Annunciations ----- 10

3.2 Visual Annunciations ----- 11

3.3 Options ----- 12

4. RUNWAY AWARENESS AND ADVISORY SYSTEM (RAAS) ----- 12

4.1 RAAS Availability and Options ----- 12

4.2 RAAS Routine Advisories ----- 16

4.3 RAAS Non-Routine Advisories ----- 23

4.4 RAAS Assumptions, Limitations and Constraints ----- 35

5. STABILIZED APPROACH MONITOR ----- 37

5.1 Stabilized Approach Monitor Availability and Options ----- 37

5.2 Stabilized Approach Monitor Sub-Monitors ----- 40

5.3 Assumptions, Limitations and Constraints ----- 49

6. ALTIMETER MONITOR ----- 50

6.1 Altimeter Monitor Availability and Options ----- 50

6.2 Altimeter Monitor Sub-Monitors ----- 52

6.3 Assumptions, Limitations, and Constraints ----- 55

7. TAKEOFF FLAP CONFIGURATION MONITOR ----- 55

Product Description – SmartRunway®/SmartLanding®

7.1	Takeoff Flap Configuration Monitor Availability and Options	56
7.2	On Runway – Takeoff Flap Configuration Monitor	57
7.3	Assumptions, Limitations and Constraints	59
8.	LONG LANDING MONITOR	60
8.1	Long Landing Monitor Availability and Options	60
8.2	Long Landing Monitor	61
8.3	Assumptions, Limitations and Constraints	64
9.	CONFIGURATION, ENABLE KEY, AND PROGRAM PIN	65
9.1	Enable Key	66
9.2	Reloadable Customer Definitions (RCD)	66
9.3	Incorporation of the Pilot’s Point of View	67
9.4	RCD Program Pin	72
9.5	Visual Message Options	72
	APPENDICES	73
	Appendix A: Definitions	73
	Appendix B: Runway Awareness and Advisory System Visuals, Aural and Volume Levels	74
	Appendix C: Stabilized Approach Monitor Visuals, Aural and Volume Levels	79
	Appendix D: Altimeter Monitor Visuals, Aural and Volume Levels	80
	Appendix E: Takeoff Flap Configuration Monitor Visuals, Aural and Volume Levels	82
	Appendix F: Long Landing Monitor Visuals, Aural and Volume Levels	83
	Appendix G: Aircraft Compatibility Tables	84
	Appendix H: Boeing OEM RAAS installation	92

1. Purpose and Applicability

The purpose of this document is to describe the functions and features of the Honeywell SmartRunway® and SmartLanding® flight safety functions included in the Enhanced Ground Proximity Warning System (EGPWS), all of which are non-TSO functions.

The SmartRunway® function includes the following:

The Runway Awareness & Advisory System (RAAS), including Taxiway Landing and optional caution level alerts for Taxiway Takeoff and Short Runway on takeoff and landing. These provide alerts and advisories to increase crew situational awareness during operations on and around airports. It also includes the Incorrect Takeoff Flap Configuration Monitor.

The SmartLanding® function includes the following:

The airborne and landing rollout calls of the Runway Awareness & Advisory System (RAAS), the Stabilized Approach Monitor, the Long Landing Monitor, and the Altimeter Monitor.

This Product Description does not address the TSO functions included in the EGPWS, nor does it address some of the older developed non-TSO functions. Refer to the *Product Specification for the Enhanced Ground Proximity Warning System (EGPWS)* for specifics on EGPWS design, performance, environmental and software design requirements, and all other functions and features included in the EGPWS: Honeywell Document 965-0976-603, Revision V or later for the MKV and MKVII EGPWS platforms and Honeywell Document PDS69000940-000 for the next generation MVK-A platform.

The functions, as described herein, are only applicable to the following EGPWS part numbers:

965-0976-0xx-230-230 or later (MKV)
965-1076-0xx-230-230 or later (MKVII)
965-1690-054 or later (MKV)
965-1676-004 or later (MKV)
69000940 (MKV-A)
69000941 (MKV-A)
69000942 (MKV-A)

In addition to the part number applicability, Terrain Database 454 (or later) is required. Note that a S/W mod may be required in order to use databases 456 and later - refer to section 4.1.1 for more information. For prior part numbers only the functionality described in Honeywell document 060-4404-000 is available.

2. System Overview

System overviews of the non-TSO functions of Runway Awareness and Advisories, Stabilized Approach Monitor, Altimeter Monitor, Takeoff Flap Configuration Monitor, and Long Landing Monitor are described in this section. These functions offer significant safety enhancements for aircraft equipped with Honeywell's MKV, MKVII, or MKV-A Enhanced Ground Proximity Warning System (EGPWS). They are software enhancements hosted in the EGPWC.

Figure 2-1 provides a functional block diagram of all functions within the EGPWC.

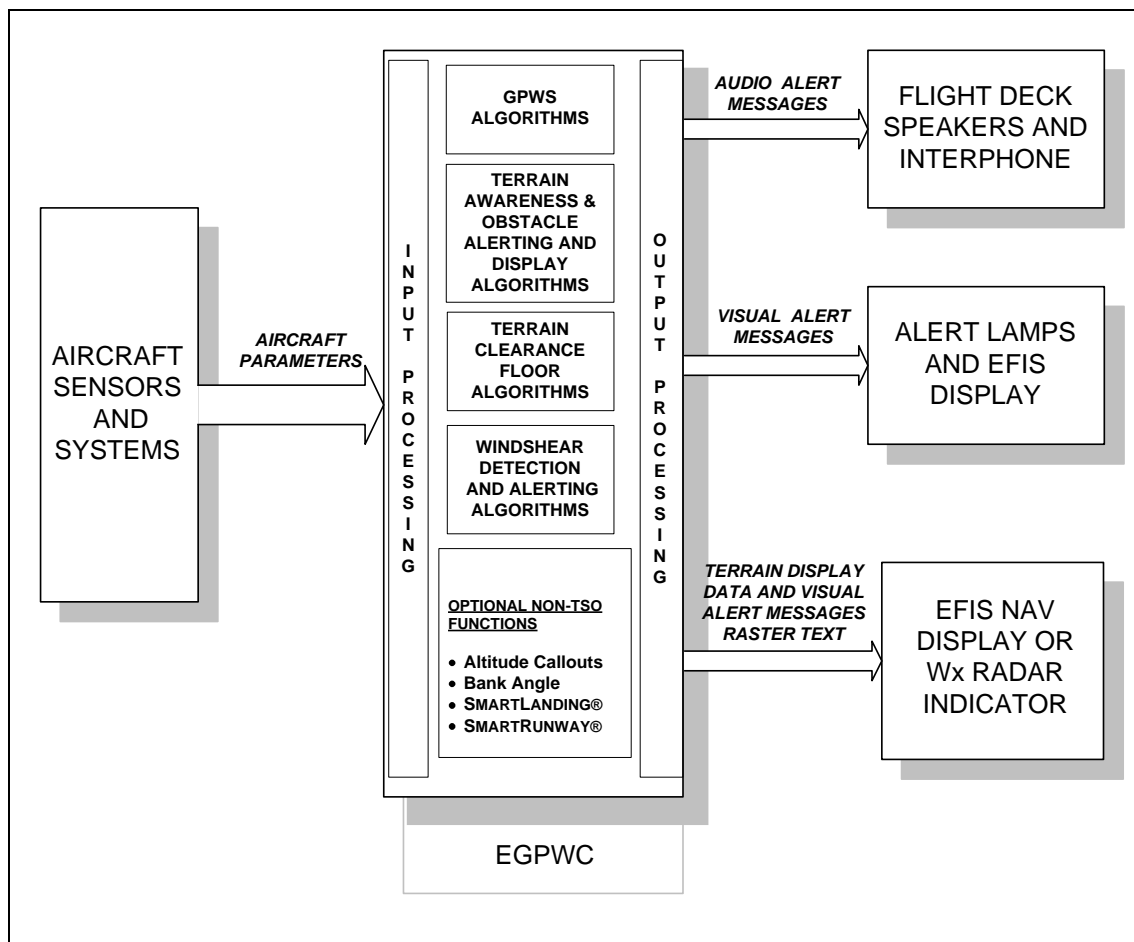

Figure 2-1: EGPWC Functional Block Diagram

Refer to Figure 2-1. The system comprises the following groups of components:

- Previously installed Enhanced Ground Proximity Warning Computer (EGPWC), with the following interfaces:
 - Aircraft sensors and other systems providing input signals, including a direct connection to GPS
 - Flight deck audio systems (speakers and interphone)
 - Alert lamps and/or digital outputs to EFIS displays (for alert messages)
 - EFIS Navigation Display (ND) or weather radar indicator for display of terrain
- For the MK V and MK VII EGPWS: Software Version 230-230 or later with a serial number EGPWC unit that has been enabled to use the functions described in this document (this is referred to as the 'Enable Key being Set'), or EGPWS Software Version 965-1690-054 or later with the Enable Key Set, or 965-1676-004 or later with the Enable Key Set. For the MK V-A EGPWS: Software Version 01.01 or later and Enable Key Set, or EGPWS software version 51.01 or later and enable key set. Refer to section 9.1 for more information on the Enable Key.

Use of the Excessive Speed Monitor on MKV and MKVII EGPWS may require use of Software Version 232-232, or 965-1690-055, or 965-1676-005 or later. Refer to Appendix G for more information.

- Terrain Database 454 or later. Note that a S/W mod may be required in order to use databases 456 and later – refer to section 4.1.1 for more information.
- RCD - Reloadable Customer Definitions (configuration file to activate and specify options for the functions described in this document). For the MKV-A EGPWS, an OSS (Option Selection Software) configuration file may be used in place of the RCD. All the functions in this document that are described as using the RCD may also be enabled and configured using the OSS.

2.1 Runway Awareness and Advisory System (RAAS)

The Runway Awareness and Advisory System (RAAS) offers improved situational awareness for the flight crew in order to help lower the probability of runway incursion incidents and accidents by providing timely aural messages to the flight crew during ground taxi, takeoff (including rejected takeoffs), final approach, and landing/roll-out operations. Existing EGPWS protection and operation is unaltered by the addition of RAAS.

Advisories/cautions are generated based upon the current aircraft position when compared to the location of the airport runways, which are stored within the Honeywell EGPWS Runway Database.

The aural messages can be grouped into two categories:

- Routine Advisories (annunciations the flight crew will hear during routine operations) and
- Non-Routine Advisories/Cautions (annunciations the flight crew will seldom or perhaps never hear).

RAAS provides the flight crew with five ‘routine’ advisories. Three of these annunciations will be heard by the crew in normal operations, providing increased position awareness relative to the runway during taxi and flight operations. They are intended to reduce the risk of a runway incursion. The two remaining ‘routine’ advisories provide information about the aircraft location along the runway, and are intended to reduce the risk of overruns. These advisories are:

- Approaching Runway - In Air advisory provides the crew with awareness of which runway the aircraft is lined-up with on approach.
- Approaching Runway - On-Ground advisory provides the flight crew with awareness of a proximate runway edge being approached by the aircraft during taxi operations.
- On Runway advisory provides the crew with awareness of which runway the aircraft is lined-up with.
- Distance Remaining advisories enhance crew awareness of aircraft along-track position relative to the runway end.
- Runway End advisory is intended to improve flight crew awareness of the position of the aircraft relative to the runway end during low visibility conditions.

In addition, RAAS provides the flight crew with several ‘non-routine’ advisories/cautions. These annunciations are designed to enhance safety and situational awareness in specific situations not routinely encountered during normal aircraft operations. Some of the RAAS advisories include distance information. The unit of measure used for distance can be configured to be either meters or feet.

- Approaching Short Runway - In-Air advisory provides the crew with awareness of which runway the aircraft is lined-up with, and that the runway length available may be marginal for normal landing operations. If desired, an additional caution annunciation can be enabled which provides the crew with awareness that the issue has not been resolved when the aircraft is on final approach.
- Insufficient Runway Length - On-Ground Advisory provides the crew with awareness of which runway the aircraft is lined-up with, and that the runway length available for takeoff is less than the defined minimum takeoff runway length. If desired, an additional caution annunciation can be enabled which provides the crew with awareness that the issue has not been resolved when the aircraft is on the final stage of takeoff.
- Extended Holding on Runway advisory provides crew awareness of an extended holding period on the runway.
- Taxiway Take-Off advisory enhances crew awareness of excessive taxi speeds or an inadvertent take-off on a taxiway. If desired, this function can provide a caution annunciation in lieu of an advisory annunciation.
- Distance Remaining advisories provides the flight crew with position awareness during a Rejected Take-Off (RTO).
- Taxiway Landing alert provides the crew with awareness that the aircraft is not lined up with a runway at low altitudes.

Product Description – SmartRunway®/SmartLanding®

Each RAAS function is independently enabled using the RCD. When enabled, the RAAS functions operate automatically, without any action required from the flight crew.

In addition to the aural annunciations provided, visual annunciations can be activated in the form of caution indications if the annunciations are considered cautions. Visual text annunciations can also be configured to be overlaid on the terrain display for a period of time when the condition is entered. System inoperative messages may be indicated as required using existing GPWS inoperative indications or dedicated RAAS INOP indications (MKV-A EGPWS or MKV/MKVII -236-236, -057, -006 software versions and later) if supported by aircraft. RAAS inoperative status will be indicated during the EGPWS Self Test if RAAS is enabled via the RCD and the status indicates the function is inoperative. RAAS status can be optionally displayed on the Terrain Display. This is active only when the aircraft is on the ground. Depending on the status, the message may be shown immediately, or it may require a change in the displayed range (to a higher or lower range) in order to be viewable. Inhibition of the RAAS function via an external cockpit selection may be configured.

2.2 Stabilized Approach Monitor

Important note: To use the Stabilized Approach Monitor's Excessive Speed Alert, the EGPWS must have a source of Approach or Reference Speed. For some aircraft, this means adding additional wiring to connect to an ARINC 429 source for this data. Refer to Appendix G for a list of EGPWS aircraft types that can select the Excessive Speed Monitor.

The Stabilized Approach Monitor offers a significant safety advancement to supplement flight crew awareness of unstabilized approaches as described below. Existing EGPWS protection and operation is unaltered by the addition of the Stabilized Approach Monitor.

The Stabilized Approach Monitor uses the inputs described below and the Honeywell EGPWS Runway Database to provide visual and aural annunciations that supplement flight crew awareness of unstabilized approaches as described below.

An unstabilized approach can lead to a runway overrun accident as a result of long touchdown and/or insufficient runway length left to stop. Many airlines view an unstabilized approach as one of the biggest remaining safety issues. They have created “approach gates” in their Standard Operating Procedures (SOP) to help pilots decide whether a go-around action needs to be taken. The gates are typically at 1,000 feet and 500 feet above field elevation (AFE). A typical SOP states that the aircraft should be stabilized by 1,000ft AFE, and must be stabilized by 450ft AFE. A go-around must be initiated if the stabilized approach criteria are not satisfied. The stabilized approach criteria can vary from operator to operator, and also on the type of approach (precision approach vs. non-precision approach, for example). The criteria for a stabilized approach for air transport category aircraft is typically:

- Landing Gear down
- Landing Flaps set
- Aircraft Speed within the final approach speed +10 knots / -5 knots
- Vertical Speed less than -1,000 fpm
- Aircraft on approach profile (Glideslope and Localizer captured)

The Stabilized Approach Monitor function can monitor these parameters during the approach and automatically issues advisories if the stabilized approach criteria for Flaps, Speed, and approach profile are not met.

The aircraft is stabilized during the final approach if the aircraft is fully configured to land and the aircraft's energy is properly managed. If the aircraft is not configured properly at certain gates or is flown with excessive energy, the Stabilized Approach Monitor function issues an annunciation indicating which parameter needs attention giving the pilot a chance to correct the problem. When the aircraft reaches the final “gate”, which is typically 450ft AFE and the problem(s) still exists, an “*Unstable Unstable*” alert is issued suggesting a go-around.

The Stabilized Approach Monitor specifically has the following monitoring functions:

- Landing Flap Monitor – Issues an annunciation if the landing flaps are not set.

Product Description – SmartRunway®/SmartLanding®

- Excessive Speed Monitor – Issues an annunciation if the aircraft speed becomes excessive compared to the final approach speed (V_{ref} or V_{app}).
- Excessive Approach Angle Monitor – Issues an annunciation if the aircraft approach angle to the runway threshold becomes too steep.
- Unstabilized Approach Monitor – Issues an annunciation if the aircraft has not been stabilized at the 450 foot Gate.

Each of the first three Stabilized Approach Monitor functions is independently enabled via the RCD. The Unstable monitor is automatically enabled when any of the other monitors are selected. When enabled, the Stabilized Approach Monitors operate automatically, without any action required from the flight crew.

In addition to the aural annunciations provided, visual annunciations can be activated in the form of caution indications if the annunciations are considered cautions. Visual text annunciations can also be configured to be overlaid on the terrain display for a period of time when the monitor condition is entered. System inoperative messages may be indicated as required using existing GPWS inoperative indications or dedicated RAAS INOP indications (MKV-A EGPWS or MKV/MKVII -236-236, -057, -006 software versions and later) if supported by aircraft. The Stabilized Approach Monitor inoperative status will be indicated during the EGPWS Self Test if any one of the monitors is enabled via the RCD and the status indicates the function is inoperative. Inhibition of the Stabilized Approach Monitor function via an external cockpit selection may be configured.

2.3 Altimeter Monitor

Important note: To use the Altimeter Monitor the EGPWS must have a source of both Corrected Barometric Altitude and Static Air Temperature. Refer to Appendix G for a list of MKV EGPWS aircraft types and MKVII Air Data Interface types that can support the Altimeter Monitor.

The Altimeter Monitor offers a significant safety advancement to provide the flight crew with awareness of problems with the pressure altitude system. Existing EGPWS protection and operation is unaltered by the addition of the Altimeter Monitor.

The Altimeter Monitor uses existing altitude sources and the Honeywell EGPWS Runway Database to provide aural and visual annunciations as described below.

The Altimeter Monitor continuously monitors the corrected altitude input to the EGPWS and alerts the crew if an error in the altitude is detected. The Altimeter Monitor provides protection against incorrectly set or erroneous altimeter settings and can help ensure a proper altitude reference is being used, especially for RNP or VNAV based approach procedures.

The Altimeter Monitor function provides the flight crew with two advisories that inform of improper altimeter setting. The first monitor, the Below Transition Altitude Monitor, provides the flight crew with awareness of improper corrected altitude setting while operating below the transition altitude. For this monitor a cross-check of Corrected Altitude against GPS altitude below the transition altitude is performed to detect an incorrect altimeter setting. This monitor also cross-checks the GPS Altitude to prevent nuisance advisories caused by erroneous GPS Altitude values. The second monitor, the Above Transition Altitude Monitor, provides the flight crew with awareness if the altitude reference is not set to standard pressure altitude after climbing above the transition altitude. On aircraft where the altitude reference is available, the monitor verifies that it is set to standard pressure; otherwise the monitor performs a comparison of Corrected Altitude against Uncorrected Altitude and then performs a check of the selected barometric reference to detect a failure to reset to standard altitude.

For enabling both the Below Transition Altitude Monitor and the Above Transition Altitude Monitor, the EGPWS must determine the appropriate transition altitude. The runway database includes transition altitudes for each runway. During takeoff, the EGPWS initially selects the transition altitude for the departure runway. Once the aircraft is airborne, the standard runway selection logic will select the runways and corresponding transition altitudes for the closest airports along the flight path. In order to prevent the premature selection of the Above Transition Altitude advisory, the transition altitude used by the Altimeter Monitor will be the highest selected since the takeoff. Once the aircraft has climbed and remained above this highest transition altitude for more than 5 minutes, then the logic begins using the currently selected transition altitude.

Product Description – SmartRunway®/SmartLanding®

If the aircraft descends below the currently selected transition altitude for more than 30 seconds the below transition altitude monitor can be enabled.

Each Altimeter Monitor function is independently enabled using the RCD. When enabled, the Altimeter Monitors operate automatically, without any action required from the flight crew.

In addition to the aural annunciations provided, visual text annunciations can also be configured to be overlaid on the terrain display for a period of time when the monitor condition is entered. System inoperative messages may be indicated as required using existing GPWS inoperative indications or dedicated RAAS INOP indications (MKV-A EGPWS, or MKV/MKVII EGPWS -236-236, -057, -006 software versions and later) if supported by aircraft. The Altimeter Monitor inoperative status will be indicated during the EGPWS Self Test if any one of the monitors is enabled via the RCD and the status indicates the function is inoperative. Inhibition of the Altimeter Monitor function via an external cockpit selection may be configured (MKV-A EGPWS, or MKV/MKVII EGPWS -236-236, -057, -006 software versions and later).

2.4 Takeoff Flap Configuration Monitor

Important note: To use the Takeoff Flap Configuration Monitor, the EGPWS installed on the aircraft must be connected to a source of flap position. Refer to Appendix G for a list of EGPWS aircraft types that support such a connection.

The Takeoff Flap Configuration Monitor offers a significant safety advancement to provide the flight crew with awareness of improper Flap setting when the aircraft is lined-up on a runway in advance of takeoff. With the benefit of a “virtual” box around the EGPWS runway data, the alert is provided well before thrust levers are advanced for runway takeoff. Existing EGPWS protection and operation is unaltered by the addition of the Takeoff Flap Configuration Monitor.

The Takeoff Flap Configuration Monitor uses GPS position data and the Honeywell EGPWS Runway Database to provide aural and visual annunciations that supplement flight crew awareness of flap setting during ground operations as described below.

The Takeoff Flap Configuration Monitor adds one new aural message which is activated when the flap handle is not within the valid takeoff setting when the aircraft enters and is aligned with a runway.

The Takeoff Flap Configuration Monitor function is enabled using the RCD. When enabled, the Takeoff Flap Configuration Monitor operates automatically, without any action required from the flight crew.

In addition to the aural annunciations provided, visual annunciations can be activated in the form of caution indications if the annunciations are considered cautions. Visual text annunciations can also be configured to be overlaid on the terrain display for a period of time when the monitor condition is entered. System inoperative messages may be indicated as required using existing GPWS inoperative indications or dedicated RAAS INOP indications (MKV-A EGPWS, or MKV/MKVII EGPWS -236-236, -057, -006 software versions and later) if supported by aircraft. The Takeoff Flap Configuration Monitor inoperative status will be indicated during the EGPWS Self Test if the monitor is enabled via the RCD and the status indicates the function is inoperative. Inhibition of the Takeoff Flap Configuration Monitor function via an external cockpit selection may be configured.

2.5 Long Landing Monitor

The Long Landing Monitor function offers the pilot increased runway awareness and complements the RAAS Distance Remaining callouts. The function advises the crew of their position during a landing when the aircraft has not touched down in a nominal amount of time and/or distance. Existing EGPWS protection and operation is unaltered by the addition of the Long Landing.

The Long Landing function adds two new distance remaining annunciations to enhance crew awareness of aircraft along-track position relative to the runway end. If the aircraft has not touched down before a configurable threshold, the EGPWS will activate an aural message. In addition, airborne only aural annunciations of current distance from aircraft to the runway end can be enabled.

Product Description – SmartRunway®/SmartLanding®

The Long Landing function is enabled using the RCD. When enabled, the Long Landing function operates automatically, without any action required from the flight crew.

In addition to the aural annunciations provided, visual annunciations can be activated in the form of caution indications if the annunciations are considered cautions. Visual text annunciations can also be configured to be overlaid on the terrain display for a period of time when the condition is entered. System inoperative messages may be indicated as required using existing GPWS inoperative indications or dedicated RAAS INOP indications (MKV-A EGPWS, or MKV/MKVII EGPWS -236-236, -057, -006 software versions and later) if supported by aircraft. The Long Landing inoperative status will be indicated during the EGPWS Self Test if the monitor is enabled via the RCD and the status indicates the function is inoperative. Inhibition of the Long Landing function via an external cockpit selection may be configured.

3. General Characteristics

3.1 Aural Annunciations

The functions described herein use existing EGPWS voice and audio technology to generate aural messages. These messages are heard over the same aircraft audio systems that presently provide EGPWS audio Caution and Warning alerts in the flight deck. The volume of these messages is controlled by the EGPWS and is based on the expected flight operation for each advisory.

Every aural generated is listed and detailed in the following sections of this document. A summary of all voices is contained in Appendices B through F. The aural may be specified to be a Male or Female voice.

RAAS calls are mutually exclusive in annunciation. In the event that multiple RAAS calls occur at the same time, they will be issued in the following order (Note: Long Landing Monitor and Takeoff Flaps Configuration Monitor are included here as they can be selected with RAAS):

- Approaching Runway In Air
- Approaching Short Runway In Air
- Caution Short Runway In Air
- On Runway
- Caution Short Runway On Ground
- On Short Runway (Insufficient Runway Length On Ground)
- Long (Deep) Landing
- Taxiway Landing
- Approaching Runway On Ground
- On Taxiway
- Extended Holding
- Takeoff Flap

Distance Remaining – Landing and Roll-Out and Distance Remaining – Rejected Take-Off advisories are not included in the priority list above. The Distance Remaining advisories cannot be enabled when the above listed advisories are enabled.

The Stabilized Approach Monitor callouts are mutually exclusive in annunciation. In the case of multiple monitors being satisfied in the Unstable Window when no previous Stabilized Approach Monitor calls have been issued, then one, and only one, precursor voice is issued prior to the Unstable voice, selected in the following order of priority: Too High- Too High, Too Fast- Too Fast, Flaps-Flaps.

The Altimeter Monitor callouts are mutually exclusive in annunciation, as one occurs above transition altitude, the other below transition altitude.

Although there are default volumes for each monitor described in this document, the operator can choose to adjust the volume levels via the RCD.

3.2 Visual Annunciations

The monitors described in this document can provide three types of visual annunciation.

- 1) Textual messages presented on the Terrain Display
- 2) GPWS Caution Lamp activation for cautions
- 3) RAAS Status Messages

3.2.1 Textual Annunciations on Terrain Display

Via the RCD, the operator can select whether the EGPWS will present text messages on the Terrain display for none of the following events, all of the following events, or just for those events listed as cautions. A complete listing of the actual text messages can be found in appendices B thru F.

RAAS Approaching Runway (In Air)
RAAS Approaching Runway (On Ground)
RAAS On Runway – On Ground
RAAS Approaching Short Runway Advisory (In Air)
RAAS Approaching Short Runway Caution (In Air) - **CAUTION**
RAAS Insufficient Runway Length (On Ground)
RAAS Insufficient Runway Length Caution (On Ground) - **CAUTION**
RAAS Extended Holding - On Runway
RAAS Taxiway Takeoff Advisory
RAAS Taxiway Takeoff Caution - **CAUTION**
RAAS Taxiway Landing Caution - **CAUTION**
Stabilized Approach Monitor Landing Flap Monitor
Stabilized Approach Monitor Excessive Approach Angle Monitor
Stabilized Approach Monitor Excessive Approach Speed Monitor
Stabilized Approach Monitor Unstable Approach Monitor - **CAUTION**
Altimeter Monitor
Takeoff Flap Configuration Monitor - **CAUTION**
Long Landing Monitor - **CAUTION**

Note: The terrain display must be selected to Terrain mode in order to view these messages. Auto-pop ups for Cautions may be available for certain display types.

3.2.2 GPWS Caution Visual

If any of the following monitor functions are selected then, by default, the GPWS Alert (Caution) bit (and discrete output) will be set during the caution event. The functions that can output cautions are:

RAAS Short Runway Caution In Air
RAAS Insufficient Runway Length Caution On Ground
RAAS Taxiway Takeoff Caution
RAAS Taxiway Landing Caution
Stabilized Approach Monitor ‘Unstable-Unstable’ Caution
Takeoff Flap Configuration Monitor Caution
Long Landing Monitor Caution

Note: Some integrated displays can provide caution annunciations separate from the GPWS Caution annunciation. In this case the RCD is to be defined to make the system not activate the GPWS Caution.

3.2.3 RAAS Status Messages

The status of the RAAS function can be displayed on the Terrain Display. Refer to Table B-3 in Appendix B for more information.

3.3 Options

The options available for the functions described in this document fall into two categories:

- 1) Global Options
- 2) Aircraft Type Specific Options

Note: The sections of this document that detail each monitor function contain an 'Option' sub-section that provides more information on the various options that are selectable for the monitor

3.3.1 Global Options

Global options are options that apply to ALL installations that use a specific RCD. The global options are:

Visual Messages on terrain display (none, all, non-routine only, cautions only)

For RAAS Global options refer to Table 4-1

For SAM Global options refer to Table 5-1

For CAM Global options refer to Table 6-1

3.3.2 Aircraft Type Specific Options

Aircraft Type Specific options are options that can be set differently for various aircraft types within a given RCD. Note that these options do not provide for differences based on tail number, only on different EGPWS aircraft types.

For RAAS aircraft type specific options refer to Table 4-1

For SAM aircraft type specific options refer to Table 5-1

For CAM aircraft type specific options refer to Table 6-1

4. Runway Awareness and Advisory System (RAAS)

The Runway Awareness and Advisory System (RAAS) offers improved situational awareness for the flight crew in order to help lower the probability of runway incursion incidents and accidents by providing timely aural messages to the flight crew during ground taxi, takeoff (including rejected takeoffs), final approach, and landing/roll-out operations.

4.1 RAAS Availability and Options

4.1.1 Runway Awareness and Advisory System Operational Availability

RAAS is operationally available anytime the EGPWS is powered and the following conditions are met:

- MKV/MKVII EGPWS: Software Version 230-230 or later with a serial number EGPWC unit that has been enabled to use the functions described in this document (this is referred to as the 'Enable Key being Set'), or EGPWS Software Version 965-1690-054 or later with the Enable Key Set, or 965-1676-004 or later with the Enable Key Set. MKV-A EGPWS: software version 01.01 or later and Enable Key Set, or software version 51.01 or later and Enable Key Set. Refer to section 9.1 for more information on the Enable Key.
- Terrain Database 454 or later. Note that to use Terrain Databases 456 and later, users of the following part numbers must incorporate S/W Mod 1: 965-0976-230-230, 965-1676-004, and 965-1690-054.
- A RAAS-verified Airport is in the Runway Database (loaded as part of the Terrain Database)
- RAAS is functional (e.g. all external signals are available and not faulted, GPS position accuracy meets minimum RAAS requirements, and there are no internal EGPWC faults).
- Some installations may also require the selection of an EGPWS program pin to enable RAAS.

RAAS Operational Availability is integrated into the existing EGPWS fault monitoring and Self-Test functions.

Product Description – SmartRunway®/SmartLanding®

- For MKV/MKVII software versions prior to 965-0976-236-236, 965-1676-006, and 965-1690-057, automatic annunciation of RAAS functionality (either RAAS validity or availability) was only provided for Boeing aircraft. If any of the RAAS caution functions are enabled, there is logic implemented to activate the GPWS ALERT lamp when required as well as the GPWS INOP if RAAS is inoperative.
- For MKV-A EGPWS, or MKV/MKVII EGPWS Software versions 965-0976-236-236, 965-1676-006, and 965-1690-057 and later:

The EGPWS also provides a RAAS Monitor discrete output as well as ARINC 429 RAAS INOP and RAAS Not Available outputs.

The RAAS Monitor discrete will be active if any RCD enabled monitoring function (RAAS, Long Landing, Stabilized Approach, Altimeter, Takeoff Flap) becomes inoperative or not available. This discrete may be used to drive a dedicated RAAS INOP / Not Available lamp. Note to maintain backward compatibility that the system can be configured via the RCD to activate the GPWS INOP lamp for RAAS INOP conditions.

The ARINC 429 RAAS INOP will be active if any RCD enabled monitor function becomes INOP. Similarly the ARINC 429 RAAS Not Available will become active if any RCD enabled monitor function is not available. If supported by Crew Alerting System (CAS) these labels may be used to drive dedicated RAAS INOP or RAAS Not Available CAS messages.

Consistent with approved EGPWS Self-Test design, the loss of RAAS functions will be indicated on-ground during a level 1 Self-Test. Refer to Appendix B for a list of Self-Test maintenance messages.

RAAS status can be optionally displayed on the Terrain Display. This is active only when the aircraft is on the ground. The procedure requires the flight crew to select the Terrain Display followed by a change in the displayed range (to a higher or lower range). RAAS status is annunciated for two complete sweeps of the Terrain Display. This feature is available on all aircraft, but is primarily intended for those aircraft where the flight crew does not perform a Level 1 Self-Test. Refer to Table B-3 in Appendix B for a list of displayed status messages.

4.1.2 EGPWS Runway Database

Current EGPWS databases contain airport and runway information. However, to ensure optimal RAAS performance, the accuracy of this data will be re-verified and validated before RAAS can use the data. EGPWS Terrain database 454 and later contains additional airport and runway information that RAAS uses to determine if it can perform its intended function. Not all airports and runways contained in the database will be validated. Validation of major commercial airports will be Honeywell's first priority. However, Honeywell will support our RAAS customers by offering high priority on customer specific route structures.

4.1.3 GPS Signals Required, Accuracy and Availability

RAAS requires a high level of GPS position accuracy to function. The GPS receivers used to provide position information must have a position resolution of 50 feet or better to meet this requirement. In addition to the basic set of GPS position data, RAAS requires GPS Fine Latitude (ARINC 429 Label 120) and GPS Fine Longitude (ARINC 429 Label 121). Most ARINC 743/743A GPS systems provide these signals. The internal GPS receivers used with the EGPWS provide the needed resolution.

RAAS does not require WAAS or Differential GPS (DGPS). However, either or both could enhance position accuracy of standard GPS data. RAAS monitors GPS accuracy and will automatically become Not Available if the accuracy degrades below acceptable limits. Factors which could degrade GPS accuracy include intentional accuracy degradation (Selective Availability activated), signal multipath, ionospheric and tropospheric delays, satellite geometry and shading, and system errors such as clock inaccuracies, etc.

4.1.4 Runway Awareness and Advisory System Option Summary

There are a number of options available with RAAS. These options are included as part of the RCD and each RCD can support options for up to 20 different aircraft types. This allows an operator with a mixed fleet of aircraft to swap EGPWS LRUs across the fleet without requiring the RCD to be reloaded. The options are to be selected by the operator when the RCD is created.

Product Description – SmartRunway®/SmartLanding®

Global Options are applicable for all RAAS advisories/cautions and will be the same for all aircraft types programmed in the RCD. For example, RAAS aural annunciations may be specified to be a Male or Female voice. If the Male voice is selected, all RAAS annunciations will use the Male voice. If one advisory is set to Male, another cannot be set to Female.

Aircraft-Type Specific options can be selected differently between various aircraft types specified in the RCD. The following table indicates which options are global and which are aircraft specific.

Product Description – SmartRunway®/SmartLanding®

Table 4-1: RAAS Options

DESCRIPTION	Global Option	A/C Type Specific Option	SELECTIONS	REF SECTION
Distance Unit of Measurement	X		FEET, METERS	4 & 5
Annunciation of Unit of Measure	X		OFF, FIRST, OTHER	4.2, 4.3, & 8.2
Voice Gender	X		FEMALE, MALE	3.1
Approaching Runway – In Air	X		OFF, ON	4.2.1
Advisory Suppress Window		X	450 – 550 feet 350 – 450 feet	4.2.1, 4.3.1
Approaching Runway – On Ground	X		OFF, ON	4.2.2
On Runway	X		OFF, ON	4.2.3
Distance Remaining – Landing	X		OFF, ON <i>Note: If ON, then the advisory can be issued at either the last half of the runway (default) or a specified distance from the runway end.</i>	4.2.4
Runway End Callout	X		OFF, ON	4.2.5
Approaching Short Runway Advisory – In Air (Landing)	X		OFF, ON, ALWAYS Customer-selected nominal runway length. Based on Aircraft-Type.	4.3.1
Approaching Short Runway – In Air Caution (Landing)	X		OFF, ON Customer-selected nominal runway length. Based on Aircraft-Type.	4.3.2
Short Runway Length – In Air		X	Customer-selected nominal runway length in feet (or meters), based on Aircraft-Type.	4.3.1.5 4.3.2.5
Insufficient Runway Length Advisory – On Ground (Takeoff)	X		OFF, ON, ALWAYS Customer-selected nominal runway length. Based on Aircraft-Type.	4.3.3
Insufficient Runway Length Caution – On Ground (Takeoff)	X		OFF, ON Customer-selected nominal runway length. Based on Aircraft-Type.	4.3.4
Short Runway Length – On Ground		X	Customer-selected nominal runway length in feet (or meters), based on Aircraft-Type.	4.3.3.5 4.3.4.5
Extended Holding – On Runway	X		INITIAL: 60, 90, 120, 180, 240, 300, OFF REPEAT: 30, 60, 90, 120, 180, 240, 300, OFF	4.3.5
Taxiway Takeoff	X		OFF	4.3.6

Product Description – SmartRunway®/SmartLanding®

DESCRIPTION	Global Option	A/C Type Specific Option	SELECTIONS	REF SECTION
			ON - ADVISORY ON - CAUTION	
Distance Remaining – Rejected Takeoff	X		OFF, ON <i>Note: If ON, then the advisory can be issued at either the last half of the runway (default) or a specified distance from the runway end.</i>	4.3.7
Taxiway Landing	X		OFF, ON	4.3.8
GPS Antenna Location		X	XX Feet Customer-selected location Based on aircraft Type <i>Note: As part of RAAS implementation, advisories that use the GPS Antenna Location, also account for the Pilot's Point of View for each aircraft type.</i>	9.3
Enable Visual Messages on Terrain Display	X		NONE, ALL, NON-ROUTINE ONLY, CAUTIONS ONLY	9.5
RAAS Level 1 Self Test Response For -236-236, -057, -006 software versions and later.	X		OFF, ON “Runway Awareness Inhibited” Level 1 Self Test message when RAAS <or> Stabilized Approach Monitor <or> Altimeter Monitor are inhibited. “Runway Awareness OK” Level 1 Self Test message when RAAS is not enabled but Stabilized Approach Monitor <or> Altimeter Monitor are enabled.	Appendix B

4.2 RAAS Routine Advisories

4.2.1 Approaching Runway - In Air Advisory

The purpose of the Approaching Runway – In Air advisory is to provide the crew with awareness of which runway the aircraft is lined-up with on approach.

4.2.1.1 Annunciation Criteria

RAAS equipped aircraft provide the flight crew with an aural advisory when the aircraft is airborne and approaching a runway. This advisory is enabled when:

- Aircraft is between 750 feet and 300 feet above the airport elevation (AFE), and
- Aircraft is within 3 nautical miles (<3NM) of the approach end of the runway, and
- Aircraft track is aligned with the runway (aircraft track is within ± 20 degrees of the runway heading), and
- The aircraft position is within a variable distance laterally of the runway centerline. The required lateral

Product Description – SmartRunway®/SmartLanding®

distance is dynamically computed based on the current along track distance to the runway end and equals the runway width plus 100 Ft per NM of distance, limited to the runway width plus 200 Ft.

All EGPWS aural messages have priority over this RAAS advisory. The Approaching Runway – In Air advisory is suppressed between 550 feet and 450 feet above runway elevation to allow normal 500-foot altitude call outs and/or crew procedures without conflict. If the advisory is triggered while the aircraft is between 550 and 450 feet Above Field Elevation (AFE), the advisory is suppressed until the aircraft descends below 450 feet AFE, where the message will be annunciated.

There is an option to change the advisory suppression window from 550 – 450 to 450 – 350 feet AFE to allow the 400-foot altitude callouts in Airbus aircraft.

If the criteria above are not satisfied before the aircraft descends below 300 feet AFE, the advisory is aborted. For example, this could occur during a steep, high-energy approach with altitude call-outs taking priority over the RAAS advisory. This advisory is annunciated once for each runway alignment when the requirements noted above are satisfied. A RAAS equipped aircraft which is conducting an ILS approach to one runway and then is required to side-step to a parallel runway while on short-final would normally hear two Approaching Runway Advisory messages; one for the original (ILS) runway and the other as the aircraft aligns with the parallel runway. Refer to Figure 4-1 for an example.

4.2.1.2 Message Content

This advisory consists of the word “Approaching” followed by the runway identifier, for example, “Approaching Two-Five-Right”. Refer to Figure 4-1.

If more than one runway meets the qualifying conditions above (e.g. two runways within ± 20 degrees of heading of each other), then the message “Approaching Runways” is generated. When the system is able to resolve which runway the aircraft is approaching the advisory will be issued again with the runway identifier.

4.2.1.3 Audio Level

The aural message is generated at the EGPWS Warning volume level minus 6dB (in general, the same volume level as that defined for the EGPWS Mode 6 Altitude call-outs).

4.2.1.4 Visuals

Refer to Appendix B.

4.2.1.5 Options

The following RCD options are used by this function:

- Advisory turned On or Off.
- Voice Gender: Female or Male.
- All Visual Messages On or Off.
- Advisory suppression window: 550 – 450 feet AFE (default) or 450 – 350 feet AFE.
- GPS Antenna position on aircraft.

Product Description – SmartRunway®/SmartLanding®

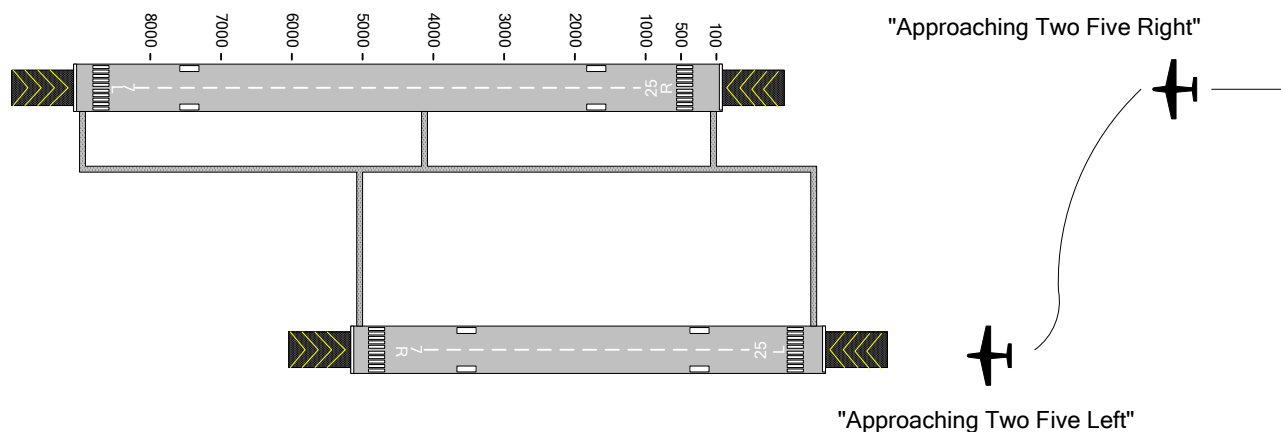

Figure 4-1: Approaching Runway – In Air Advisory

4.2.2 Approaching Runway - On Ground Advisory

The purpose of the Approaching Runway – On-Ground advisory is to provide the flight crew with awareness of a proximate runway edge being approached by the aircraft during taxi operations.

4.2.2.1 Annunciation Criteria

RAAS determines the runway identifier for the end of the runway that is closest to the position of the aircraft. This advisory is enabled when:

- Aircraft is on the ground, and
- Aircraft ground speed is less than 40 knots, and
- Aircraft is within a specified distance from the runway.

NOTE: The specified distance from the runway is a function of aircraft ground speed and closure angle with the runway; a higher ground speed will result in an earlier advisory (i.e. the aircraft is farther from the runway when the advisory is provided). For example, the minimum distance from the runway that the advisory would be provided at very low ground speeds is 1 ½ times the runway width from the runway edge to the aircraft when approaching from 90 degrees relative to the runway. As the ground speed increases, the advisory is provided farther from the runway.

4.2.2.2 Message Content

The aural message consists of the word “Approaching” followed by the runway identifier. For example, “Approaching Three-Four-Left” (refer to Figure 4-2). This advisory is issued once each time the aircraft approaches a runway. For example, if a RAAS equipped aircraft approaches a 9000-foot runway (34L / 16R), 5000 feet away from the 34L end of the runway, the advisory is “Approaching One-Six-Right”.

If more than one runway meets the qualifying conditions above (e.g. two runways within ± 20 degrees of heading of each other), then the message “Approaching Runways” is generated.

4.2.2.3 Audio Level

The aural message is generated at the EGPWS Warning volume level minus 6dB (in general, the same volume level as that defined for the EGPWS Mode 6 Altitude call-outs).

4.2.2.4 Visuals

Refer to Appendix B.

4.2.2.5 Options

The following RCD options are used by this function:

- Advisory turned On or Off.
- Voice Gender: Female or Male.
- All Visual Messages On or Off.
- GPS Antenna position on aircraft.

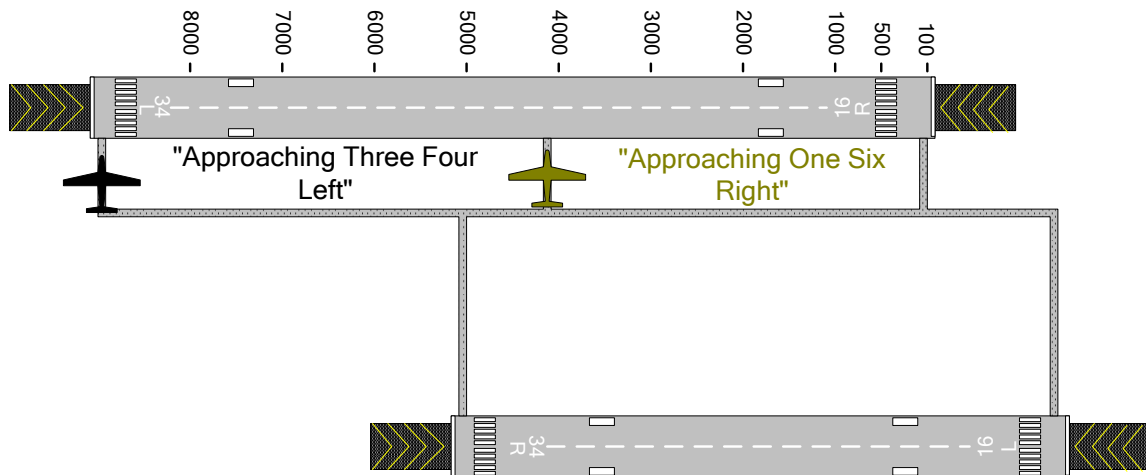

Figure 4-2: Approaching Runway - On Ground Advisory

4.2.3 On Runway – On Ground Advisory

The purpose of the On Runway Advisory is to provide the crew with awareness of which runway the aircraft is lined-up with during ground operations.

4.2.3.1 Annunciation Criteria

The On Runway advisory is generated when the following conditions are met:

- Aircraft enters onto a runway, and
- Aircraft heading is within ± 20 degrees of the runway heading.

4.2.3.2 Message Content

The aural message consists of the words “On Runway” followed by the runway identifier, for example, “*On Runway Two-Four*”, (refer to Figure 4-3 for an example). This advisory message is annunciated once each time the aircraft enters a runway.

4.2.3.3 Audio Level

The aural message is generated at the EGPWS Warning volume level minus 6dB (in general, the same volume level as that defined for the EGPWS Mode 6 Altitude call-outs).

4.2.3.4 Visuals

Refer to Appendix B.

4.2.3.5 Options

The following RCD options are used by this function:

- Advisory turned On or Off.
- All Visual Messages On or Off.
- Voice Gender: Female or Male.
- GPS Antenna position on aircraft.

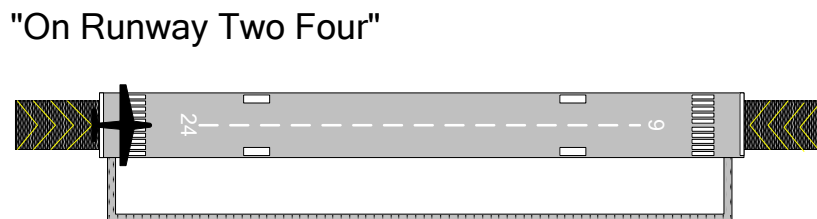

Figure 4-3: On Runway – On Ground Advisory

4.2.4 Distance Remaining – Landing and Roll-Out Advisory

The purpose of the Distance Remaining advisories is to enhance crew awareness of aircraft along-track position relative to the runway end.

4.2.4.1 Annunciation Criteria

The Distance Remaining advisory is generated when the following conditions are met:

- Aircraft is within 100 feet of the ground, over the last half of the runway or a specified distance from the runway end; or
- Aircraft is on the ground, on the last half of the runway (default) or a specified distance from the runway end, and
- Aircraft ground speed is above 40 knots.

Refer to Figure 4-4. If the crew elects to go-around after the Distance Remaining advisories are triggered, the advisories continue to be annunciated at the appropriate distances along the runway. The Distance Remaining advisories are inhibited once the aircraft climbs above 100 feet Radio Altitude or aircraft climb rate is greater than 450 fpm.

4.2.4.2 Message Content

For systems using feet as the unit of length, these advisories are generated at whole thousand-foot intervals, except that the last possible advisory occurs at 500 feet. For example, a RAAS equipped aircraft landing on a 9000 foot runway, configured with the Distance Remaining advisory issued at the last half of the runway, would generate the following advisories: “*Four-Thousand Remaining*”, “*Three-Thousand Remaining*”, “*Two-Thousand Remaining*”, “*One-Thousand Remaining*”, and “*Five-Hundred Remaining*”. A second example, of a RAAS equipped aircraft configured landing on a 9000 foot runway, with the Distance Remaining advisory issued starting at 2000 feet from the runway end, would generate the following advisories: “*Two-Thousand Remaining*”, “*One-Thousand Remaining*”, and “*Five-Hundred Remaining*”.

For systems using meters as the unit of length, these advisories are generated at multiples of 300-meter intervals, except that the last possible advisory occurs at 100 meters. For example, a RAAS equipped aircraft landing on a 3000 meter runway, with the Distance Remaining advisory issued at the last half of the runway, would generate the following advisories: “*One-Thousand-Two-Hundred Remaining*”, “*Nine-Hundred Remaining*”, “*Six-Hundred Remaining*”, “*Three-Hundred Remaining*”, and “*One-Hundred Remaining*”. A second example, of a RAAS equipped aircraft configured landing on a 3000 meter runway, with the Distance Remaining advisory issued starting at 900 meters from the runway end, would generate the following advisories: “*Nine-Hundred Remaining*”, “*Six-Hundred Remaining*”, “*Three-Hundred Remaining*”, and “*One-Hundred Remaining*”.

If the RCD option to annunciate the unit of measurement is enabled, “*Feet*” or “*Meters*” will be included in the first phrase. For example, “*Three-Thousand Feet Remaining*” followed by “*Two-Thousand Remaining*” and so on.

4.2.4.3 Audio Level

The aural message is generated at the same volume level as that defined for the EGPWS Cautions and Warnings.

4.2.4.4 Options

The following RCD options are used by this function:

- Advisory turned On or Off.
- Voice Gender: Female or Male.
- Advisory issued at last half of runway or a specified distance from the runway end.
- Distance remaining call-outs in Feet or Meters.
- Include units voice (“feet” or “meters”) in first call-out.
- GPS Antenna position on aircraft.

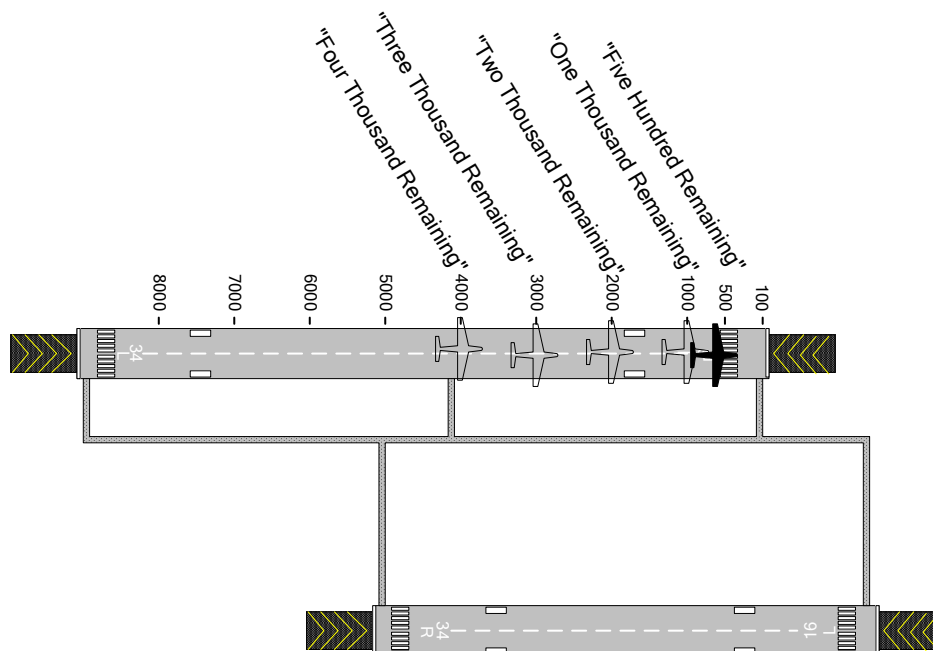

Figure 4-4: Distance Remaining – Landing and Roll – Out (in feet) Advisory

4.2.5 Runway End Advisory

The purpose of the Runway End Advisory is to improve flight crew awareness of the position of the aircraft relative to the runway end during low visibility conditions.

4.2.5.1 Annunciation Criteria

This advisory is provided to the flight crew when:

- Aircraft is on a runway and aligned within 20 degrees of runway heading, and
- Aircraft approaches within 100 feet of the runway end; and
- Aircraft ground speed is below 40 Knots.

4.2.5.2 Message Content

The aural message is “*One-Hundred Remaining*” for units of feet and “*Thirty Remaining*” for units of meters. Refer to Figure 4-5.

If the RCD option to annunciate the unit of measurement is enabled, “Feet” or “Meters” will be included in the phrase. For example, “*One-Hundred Feet Remaining*” for units of feet, and “*Thirty Meters Remaining*” for units of meters.

4.2.5.3 Audio Level

The aural message is generated at the EGPWS Warning volume level minus 6dB (in general, the same volume level as that defined for the EGPWS Mode 6 Altitude call-outs).

4.2.5.4 Visuals

Refer to Appendix B.

4.2.5.5 Options

The following RCD options are used by this function:

- Advisory turned On or Off.
- Voice Gender: Female or Male.
- Distance remaining call-outs in Feet or Meters.
- Include units voice (“feet” or “meters”) in call-out.
- GPS Antenna position on aircraft.

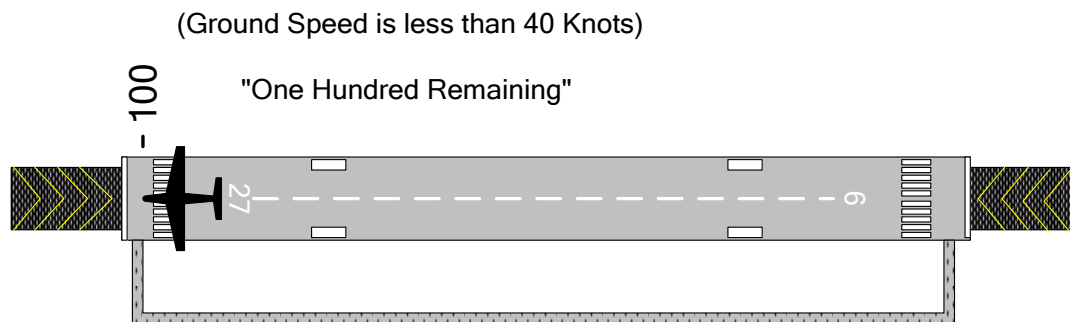

Figure 4-5: Runway End Advisory Callout (in feet) Advisory

4.3 RAAS Non-Routine Advisories

4.3.1 Approaching Short Runway – In Air Advisory

The purpose of the Approaching Short Runway – In-Air Advisory is to provide the crew with awareness of which runway the aircraft is lined-up with, and that the available runway length for landing is less than the defined nominal landing runway length. The available runway length is determined by comparing runway length as defined in the EGPWS Runway Database with the nominal runway length required for the aircraft as defined in the RCD.

4.3.1.1 Annunciation Criteria

This advisory is generated when the following conditions are met:

- All conditions for a Routine Approaching In-Air Advisory are satisfied (see section 4.2.1.1), and
- Aligned runway is shorter than a nominal runway length.

The RCD allows the option to set a nominal runway distance for landing based on a particular aircraft type specified by an operator. Refer to Section 4.1 for details on various configurable features of the RAAS advisories.

The nominal runway length value must be specified by the operator/customer or it is defaulted to OFF. This nominal runway length is used to provide advisory messages to enhance crew awareness to the fact the runway length available may be marginal for the aircraft type. The Approaching Short Runway – In Air Advisory does not take into account aircraft performance factors such as aircraft weight, wind, runway condition, slope, air temperature and altitude of airport. Note that this callout can be configured as ‘always’, meaning that the system will always annunciate the available length after alignment.

4.3.1.2 Message Content

The Routine Approaching Runway Advisory is appended with available runway length information, for example “Approaching Two-Five-Left, Three-Thousand-Eight-Hundred-Available”. Refer to Figure 4-6. The “available” element of the message refers to the runway distance available from the EGPWS runway database to the nearest 100 feet (100 meters).

Product Description – SmartRunway®/SmartLanding®

This advisory occurs once for each runway alignment based on the conditions specified in section 4.2.1 above. For example, if the aircraft aligns with a “normal” length runway followed by a side-step to a short runway, while still meeting the altitude requirements in section 4.2.1.1, two Approaching Runway advisories would be heard; the first a routine, “*Approaching Two-Five-Right*” the second, a non-routine, “*Approaching Two-Five-Left, Three-Thousand-Eight-Hundred Available*”.

If the RCD option to annunciate the unit of measurement is enabled, “*Feet*” or “*Meters*” will be included in the phrase. For example, “*Approaching Two-Five-Left, Three-Thousand-Eight-Hundred Feet Available*”.

4.3.1.3 Audio Level

The aural message is generated at the EGPWS Warning volume level minus 6dB (in general, the same volume level as that defined for the EGPWS Mode 6 Altitude call-outs).

4.3.1.4 Visuals

Refer to Appendix B.

4.3.1.5 Options

The following RCD options are used by this function:

- Advisory turned On or Off.
- Voice Gender: Female or Male.
- Distance remaining call-outs in Feet or Meters.
- Include units voice (“feet” or “meters”) in call-out.
- GPS Antenna position on aircraft.
- All Visual Messages On or Off, or Non-Routine Visual Messages Only On.
- Nominal runway length to trigger the advisory or it may be configured to always annunciate the runway length available.

NOTES:

- 1) The Approaching Short Runway – In Air advisory uses the same advisory suppression window selected for Approaching Runway In-Air advisory, Section 4.2. Either 550 – 450 feet AFE or 450 – 350 feet AFE.
- 2) The default setting for this advisory is Off. In order to activate it, the advisory must be turned On and the nominal runway length or “always” specified in the RCD.
- 3) The RCD can be programmed to support multiple nominal runway lengths based on individual aircraft type. This allows a single RCD load to be used across an entire airline fleet. Refer to Section 4.1 and Appendix B for details.

Product Description – SmartRunway®/SmartLanding®

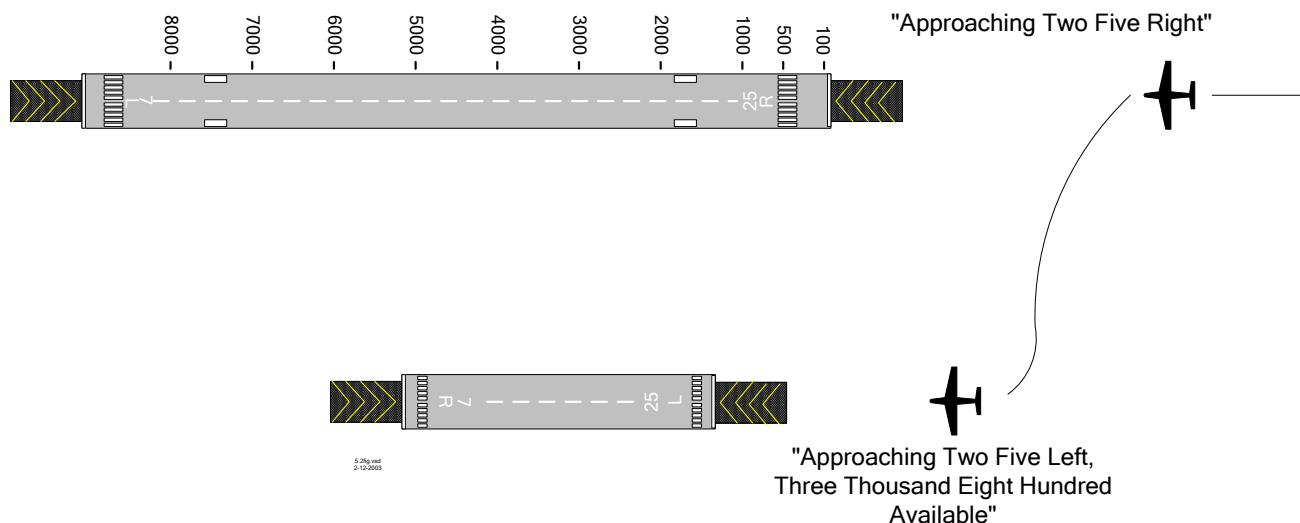

Figure 4-6: Approaching Short Runway – In Air Advisory

4.3.2 Approaching Short Runway – In Air Caution

The purpose of this annunciation is to provide the crew with immediate awareness that the available runway length for landing is still less than the defined nominal runway length when the approach is continued as noted below after the available runway length for landing has been provided.

The available runway length is determined by comparing runway length as defined in the EGPWS Runway Database with the nominal runway length required for the aircraft as defined in the RCD.

The selection of the caution, in addition to the existing advisory, is configurable via the RCD.

If the caution is desired, it is recommended that both the advisory and caution be enabled.

4.3.2.1 Annunciation Criteria

The Approaching Short Runway – In Air Caution is generated when the following conditions are met:

- All conditions for an Approaching Short In-Air Advisory are satisfied (see section 4.3.1.1), and
- Aligned runway is shorter than a nominal runway length, and
- Aircraft is below the RAAS Advisory Suppress Window (either 450 feet or 350 feet) and more than 300 feet above the airport elevation (AFE).

The RCD allows the option to set a nominal runway distance for landing based on a particular aircraft type specified by an operator. Refer to section 4.1 for details on various configurable features of the routine and non-routine advisories.

The nominal runway length value must be specified by the operator/customer or it is defaulted to OFF. This nominal runway length is used to provide advisory messages to enhance crew awareness to the fact the runway length available may be marginal for the aircraft type. The Approaching Short Runway – In Air Caution does not take into account aircraft performance factors such as aircraft weight, wind, runway condition, slope, air temperature and altitude of airport.

4.3.2.2 Message Content

The Approaching Short Runway – In Air Caution aural message is “*Caution Short Runway, Short Runway*”. Refer to Figure 4-7.

4.3.2.3 Audio Level

The aural message is generated at the EGPWS Warning volume.

4.3.2.4 Visuals

Refer to Appendix B.

4.3.2.5 Options

The following RCD options are used by this function:

- Caution turned On or Off.
- Voice Gender: Female or Male.
- GPS Antenna position on aircraft.
- All Visual Messages On or Off, Non-Routine Visual Messages Only On, or Caution Visual Messages Only On.
- Nominal runway length to trigger the caution.

NOTES:

- 1) The default setting for this caution is Off. In order to activate it, the caution must be turned On and the nominal runway length specified in the RCD.
- 2) The RCD can be programmed to support multiple nominal runway lengths based on individual aircraft type. This allows a single RCD load to be used across an entire airline fleet. Refer to section 4.1 and Appendix B for details.

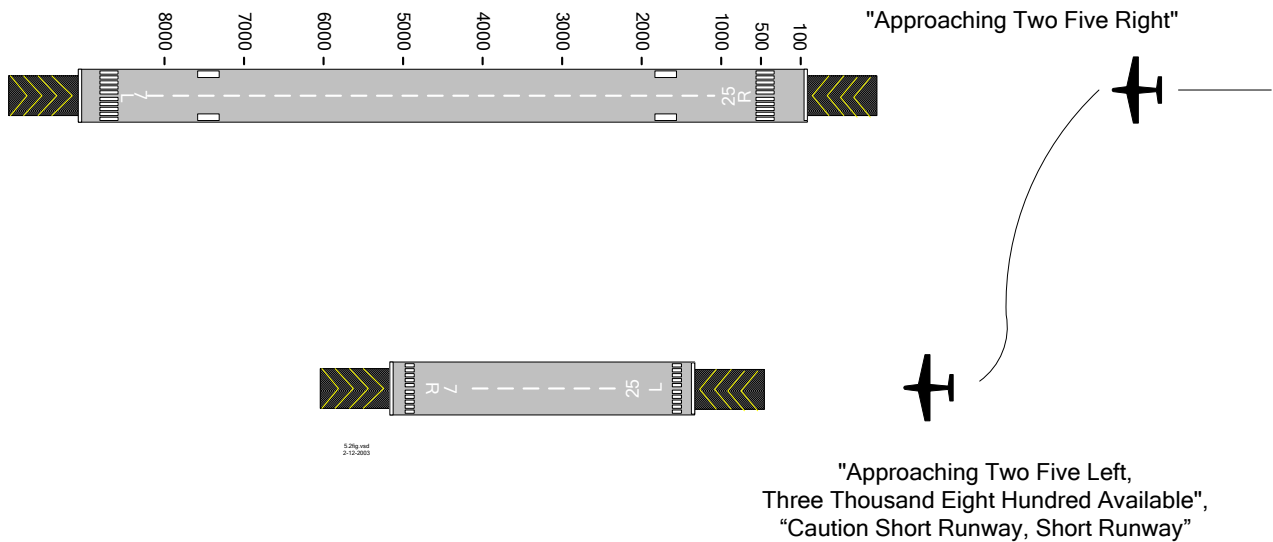

Figure 4-7: Approaching Short Runway – In Air Caution

4.3.3 Insufficient Runway Length – On-Ground Advisory

The purpose of the Insufficient Runway Length – On-Ground Advisory is to provide the crew with awareness of which runway the aircraft is lined-up with, and that the runway length available for takeoff is less than the defined nominal takeoff runway length. The available runway length is determined by comparing the aircraft's position on the runway with the distance available as defined in the EGPWS Runway Database.

4.3.3.1 Annunciation Criteria

This advisory is generated when the following conditions are met:

- All conditions for a routine On-Runway Advisory are satisfied, and
- Available distance for takeoff is less than the defined nominal runway length.

The RCD allows the option to set a “nominal” runway distance for take-off based on a particular aircraft type specified by an operator. Refer to section 4.1 for more details. If the operator does not specify the nominal runway length the advisory is defaulted to off. Once again, note that this advisory does not take into account aircraft performance factors such as aircraft weight, wind, runway condition, slope air temperature and altitude of airport. Note that this callout can be configured as ‘always’, meaning that the system will always annunciate the available length after alignment.

4.3.3.2 Message Content

Runway length remaining information is appended to the routine “*On Runway*” advisory. For example: “*On Runway Three-Four-Left, Two-Thousand Remaining*”. Refer to Figure 4-8. The “remaining” element of the message refers to the runway distance available from the EGPWS runway database to the nearest 100 feet (100 meters).

If the RCD option to annunciate the unit of measurement is enabled, “*Feet*” or “*Meters*” will be included in the phrase. For example, “*On Runway Three-Four-Left, Two-Thousand Feet Remaining*”.

4.3.3.3 Audio Level

The aural message is generated at the EGPWS Warning volume level minus 6dB (in general, the same volume level as that defined for the EGPWS Mode 6 Altitude call-outs).

4.3.3.4 Visuals

Refer to Appendix B.

4.3.3.5 Options

The following RCD options are used by this function:

- Advisory turned On or Off
- Voice Gender: Female or Male.
- Runway length remaining information in Feet or Meters.
- Include units voice (“feet” or “meters”) in call-out.
- GPS Antenna position on aircraft.
- All Visual Messages On or Off, or Non-Routine Visual Messages Only On.
- Nominal runway length to trigger advisory or it may be configured to always annunciate the runway length available.

NOTES:

- 1) The default setting for this advisory is Off. In order to activate, the advisory must be turned On and the nominal runway length or “always” specified in the RCD.
- 2) The RCD can be programmed to support multiple nominal runway lengths based on aircraft type. This allows a single RCD load to be used across an entire airline fleet. Refer to section 4.1 and Appendix B for details.

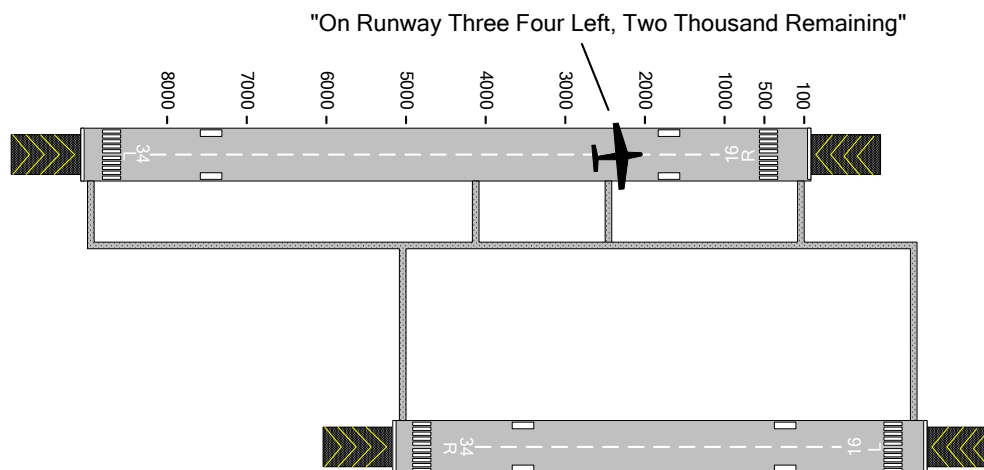

Figure 4-8: Insufficient Runway Length – On Ground Advisory

4.3.4 Insufficient Runway Length – On-Ground Caution

The purpose of this annunciation is to provide the crew with immediate awareness that the runway length available for takeoff is still less than the defined nominal takeoff runway length when the takeoff is continued as noted below after the remaining runway length for takeoff has been provided.

The available runway length is determined by comparing the aircraft’s position on the runway with the distance available as defined in the EGPWS Runway Database.

The selection of the caution, in addition to the existing advisory, is configurable via the RCD.

If the caution is desired, it is recommended that both the advisory and caution be enabled.

4.3.4.1 Annunciation Criteria

The Insufficient Runway – On-Ground Caution is generated when the following conditions are met:

- All conditions for a routine On-Runway Advisory are satisfied (section 4.2.3), and
- Available distance for takeoff is less than the defined nominal runway length, and
- Aircraft ground speed transitions to above 40 knots.

The RCD allows the option to set a “nominal” runway distance for take-off based on a particular aircraft type specified by an operator. Refer to section 4.1 for more details. If the operator does not specify the nominal runway length the advisory is defaulted to off. Once again, note that this annunciation does not take into account aircraft performance factors such as aircraft weight, wind, runway condition, slope air temperature and altitude of airport.

4.3.4.2 Message Content

The Insufficient Runway Length – On-Ground Caution aural message is “*Caution Short Runway, Short Runway*”. Refer to Figure 4-9.

4.3.4.3 Audio Level

The aural message is generated at the EGPWS Warning volume.

4.3.4.4 Visuals

Refer to Appendix B.

4.3.4.5 Options

The following RCD options are used by this function:

- Caution turned On or Off.
- Voice Gender: Female or Male.
- Nominal runway length to trigger caution.
- All Visual Messages On or Off, Non-Routine Visual Messages Only On, or Caution Visual Messages Only On.
- On GPS Antenna position on aircraft.

NOTES:

- 1) The default setting for this caution is Off. In order to activate, the caution must be turned on and the nominal runway length specified in the RCD.
- 2) The RCD can be programmed to support multiple nominal runway lengths based on individual aircraft type. This allows a single RCD load to be used across an entire airline fleet. Refer to section 4.1 and Appendix B for details.

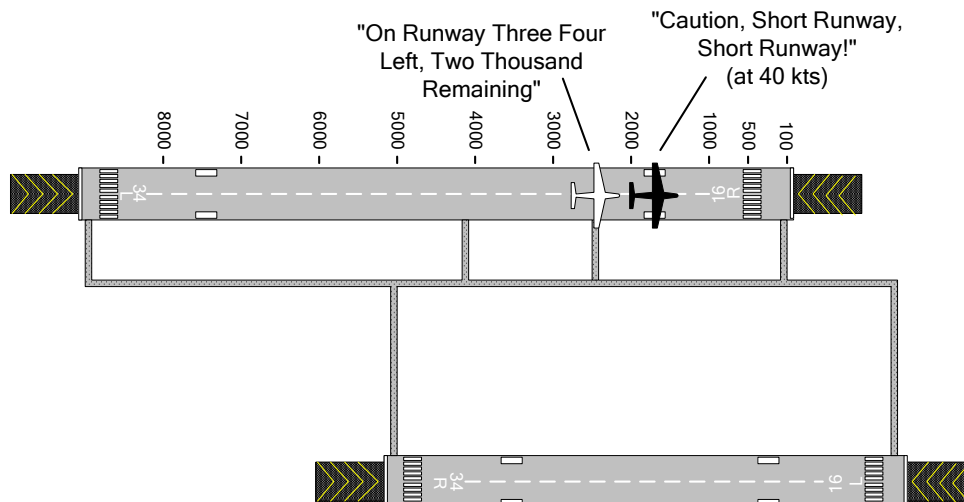

Figure 4-9: Insufficient Runway Length – Example of On Ground Advisory followed by Caution

4.3.5 Extended Holding On Runway Advisory

The purpose of the Extended Holding On Runway advisory is to provide crew awareness of an extended holding period on the runway.

4.3.5.1 Annunciation Criteria

RAAS generates the advisory when the following conditions are met:

- Aircraft must be on a runway, and
- Aircraft heading is within 20 degrees of runway heading, and
- Aircraft along-track distance does not change more than 100 ft in a period of time considered to be an extended holding period (the time period can be configured for 60, 90, 120, 180, 240, or 300 seconds).

Extended Holding On Runway advisories are suppressed after a Rejected Takeoff is detected (section 5.5). The advisory is reset when the aircraft leaves the runway.

4.3.5.2 Message Content

After the specified time period has expired, RAAS generates an advisory that consists of the aural message “On Runway” followed by the runway identifier. This advisory is annunciated twice for each time interval. For example, if an aircraft is cleared to line-up-and-wait on runway 22 and, after waiting in position for an extended period, say 90 seconds, the system will annunciate “*On Runway Two-Two, On Runway Two-Two*”.

If the aircraft continues to hold for another period of time, which may be set for the same time interval or a different time interval, the above message would repeat. The repeat advisory time may also be configured to be OFF. (See **NOTE** below).

4.3.5.3 Audio Level

The aural message is generated at the EGPWS Warning volume level minus 6dB (in general, the same volume level as that defined for the EGPWS Mode 6 Altitude call-outs).

4.3.5.4 Visuals

Refer to Appendix B.

4.3.5.5 Options

The following RCD options are used by this function:

- Advisory turned On or Off
- Voice Gender: Female or Male.
- INITIAL advisory time (seconds): 60, 90 (default), 120, 180, 240, 300, OFF.
- REPEAT advisory time (seconds): 30, 60, 90, 120 (default), 180, 240, 300, OFF.
- All Visual Messages On or Off, or Non-Routine Visual Messages Only On.
- GPS Antenna position on aircraft.

NOTE: If OFF is selected for INITIAL advisory time, then no repeat advisory is issued. The REPEAT advisory time can be turned OFF so that only an INITIAL advisory message is issued (i.e. one message for each occurrence with no follow on messages).

4.3.6 Taxiway Take-Off

4.3.6.1 Taxiway Take-Off Advisory

The purpose of the Taxiway Take-Off advisory is to enhance crew awareness of excessive taxi speeds or an inadvertent take-off on a taxiway.

4.3.6.1.1 Annunciation Criteria

The advisory is generated if:

- Ground speed of the aircraft exceeds 40 knots, and
- Aircraft is not aligned with a runway.

NOTE: RAAS functions are based on a database of runway locations. The system does not have knowledge of the location of taxiways.

4.3.6.1.2 Message Content

The aural message string “*On Taxiway! On Taxiway!*” is annunciated once each time the advisory is generated. Refer to Figure 4-10.

4.3.6.1.3 Audio Level

The aural message is generated at the EGPWS Cautions and Warnings volume level plus 3dB.

4.3.6.1.4 Visuals

Refer to Appendix B.

4.3.6.1.5 Options

The following RCD options are used by this function:

- Advisory turned On or Off
- Voice Gender: Female or Male.
- All Visual Messages On or Off, or Non-Routine Visual Messages Only On.
- GPS Antenna position on aircraft.

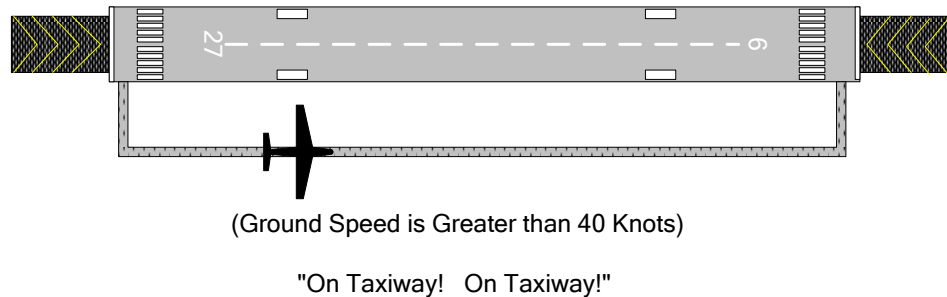

Figure 4-10: Taxiway Take-Off Advisory

4.3.6.2 Taxiway Take-Off Caution

It may be desired to classify the Taxiway take off as a Caution condition. This is done via the RCD. The caution criteria and audio level are the same as described in section 4.3.6.1 for the advisory. The visual is different (refer to Appendix B).

4.3.6.2.1 Message Content

The aural message string "Caution, *On Taxiway! On Taxiway!*" is annunciated once each time the caution is generated. Refer to Figure 4-11.

4.3.6.2.2 Options

The following RCD options are used by this function:

- Taxiway Takeoff Caution turned On or Off
- Voice Gender: Female or Male.
- All Visual Messages On or Off, Non-Routine Visual Messages Only On, or Caution Visual Messages Only On.
- GPS Antenna position on aircraft.

Product Description – SmartRunway®/SmartLanding®

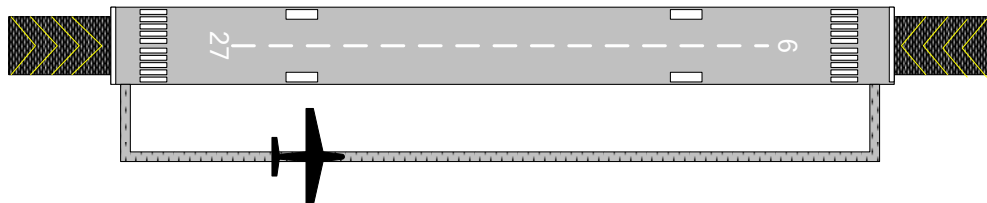

"Caution On Taxiway! On Taxiway!"
(once ground Speed exceeds 40 Knots)

Figure 4-11: Taxiway Take-Off Caution

4.3.7 Distance Remaining – Rejected Take-Off Advisory

RAAS provides distance remaining advisories to provide the flight crew with position awareness during a Rejected Take-Off (RTO), refer to Figure 4-12.

4.3.7.1 Annunciation Criteria

The advisory is generated if:

- Aircraft is on a runway, and
- Ground speed is greater than 40 knots, and
- Aircraft ground speed during the take-off roll decreases by 7 knots from its maximum, and
- Aircraft is on the last half of the runway (default) or a specified distance from the runway end.

RAAS will provide distance remaining advisories as detailed in section 4.2.4. When the ground speed decreases below 40 knots, these advisories will terminate.

Extended Holding On Runway advisories are suppressed after a Rejected Takeoff is detected (section 4.3.5). The advisory is reset when the aircraft leaves the runway.

4.3.7.2 Message Content

For systems using feet as the unit of length, these advisories are generated at whole thousand-foot intervals, with the last possible advisory occurring at 500 feet. For example, a RAAS equipped aircraft aborting a takeoff on a 9000 foot runway, with the Distance Remaining advisory issued at the last half of the runway, would generate the following advisories: *“Four-Thousand Remaining”*, *“Three-Thousand Remaining”*, *“Two-Thousand Remaining”*, *“One-Thousand Remaining”*, and *“Five-Hundred Remaining”*. A second example, a RAAS equipped aircraft aborting a takeoff on a 9000 foot runway, with the Distance Remaining advisory issued starting at 2000 feet, would generate the following advisories: *“Two-Thousand Remaining”*, *“One-Thousand Remaining”*, and *“Five-Hundred Remaining”*.

For systems using meters as the unit of length, these advisories are generated at multiples of 300-meter intervals, with the last possible advisory occurring at 100 meters. For example, a RAAS equipped aircraft aborting a takeoff on a 3000 meter runway, with the Distance Remaining advisory issued at the last half of the runway, would generate the following advisories: *“One-Thousand-Two-Hundred Remaining”*, *“Nine-Hundred Remaining”*, *“Six-Hundred Remaining”*, *“Three-Hundred Remaining”*, and *“One-Hundred Remaining”*. A second example, a RAAS equipped aircraft aborting a takeoff on a 3000 meter runway, with the Distance Remaining advisory issued starting at 600 meters, would generate the following advisories: *“Six-Hundred Remaining”*, *“Three-Hundred Remaining”*, and *“One-Hundred Remaining”*.

If the RCD option to annunciate the unit of measurement is enabled, *“Feet”* or *“Meters”* will be included in the phrase for the first distance remaining callout. For example, *“Four-Thousand Feet Remaining”*, *“Three-Thousand Remaining”*, *“Two-Thousand Remaining”*, *“One-Thousand Remaining”*, and *“Five-Hundred Remaining”*. Another example for meters is as follows: *“Six-Hundred Meters Remaining”*, *“Three-Hundred Remaining”*, and *“One-Hundred Remaining”*.

4.3.7.3 Audio level

The aural message is generated at the EGPWS Cautions and Warnings volume level.

4.3.7.4 Visuals

There are no visuals associated with this function.

4.3.7.5 Options

The following RCD options are used by this function:

- Advisory turned On or Off
- Voice Gender: Female or Male.
- Distance call-outs in Feet or Meters.
- Include units voice (“feet” or “meters”) in first call-out.
- Advisory issued at last half of runway or a specified distance from the runway end.
- GPS Antenna position on aircraft.

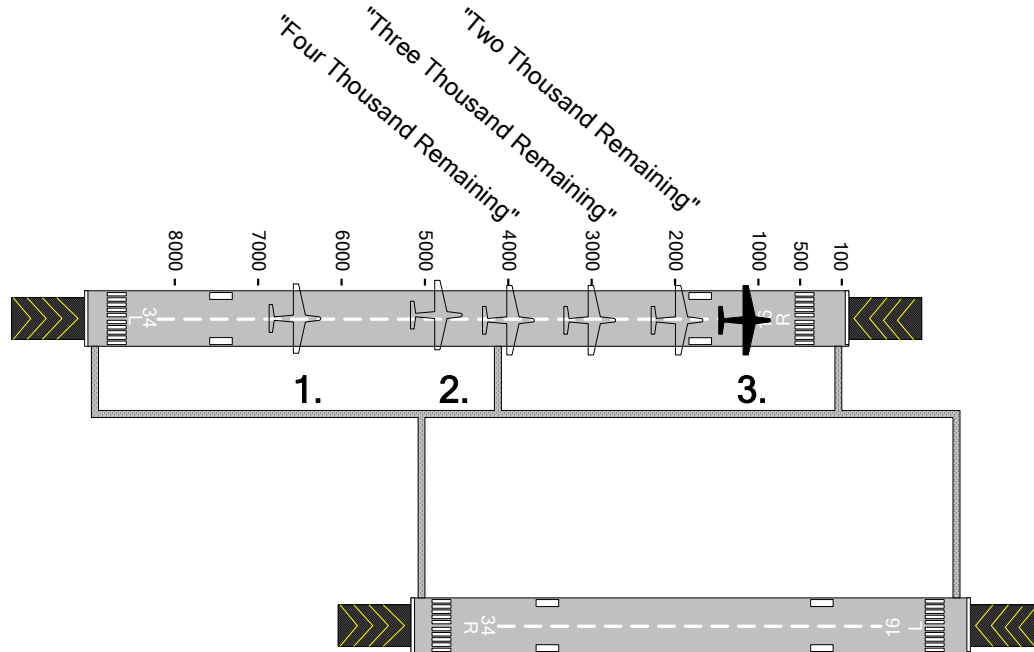

1. Aircraft accelerates on runway, ground speed exceeds 40 Knots.
2. Aircraft Ground speed decreases by 7 knots, the aircraft is on the last half of the runway, and the ground speed is above 40 Knots.
3. Distance remaining callouts continue until the aircraft ground speed is less than 40 Knots.

Figure 4-12: Rejected Take-Off, Distance Remaining Advisory

4.3.8 Taxiway Landing

The purpose of the Taxiway Landing caution is to provide crew awareness that the aircraft is not lined up with a runway at low altitudes.

4.3.8.1 Annunciation Criteria

The caution is generated if:

- Aircraft is airborne between 150 and 250 feet AGL (Radio Altitude), and
- Aircraft climb rate is less than 450 FPM, and
- Aircraft is within 5 NM of a runway and is not lined-up with a runway.

NOTE: RAAS functions are based on a database of runway locations. The system does not have knowledge of the location of taxiways.

4.3.8.2 Message Content

The aural message string “*Caution Taxiway, Caution Taxiway*” is annunciated once each time the caution is generated. Refer to Figure 4-13.

4.3.8.3 Audio Level

The aural message is generated at the EGPWS Cautions and Warnings volume level.

4.3.8.4 Visuals

Refer to Appendix B.

4.3.8.5 Options

The following RCD options are used by this function:

- Caution turned On or Off
- Voice Gender: Female or Male.
- All Visual Messages On or Off, Non-Routine Visual Messages Only On, or Caution Visual Messages Only On.
- GPS Antenna position on aircraft.

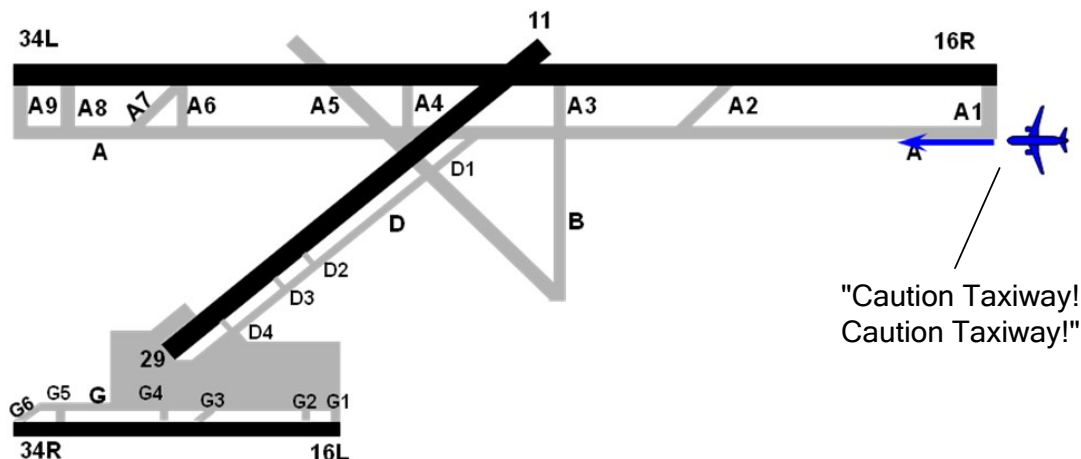

Figure 4-13: Taxiway Landing Caution

4.4 RAAS Assumptions, Limitations and Constraints

- Honeywell’s Runway Awareness and Advisory System provides the flight crew with advisory and caution aural messages. These advisory/caution annunciations are provided to supplement flight crew position awareness.
- Appropriate flight crew action to the routine RAAS advisories is:
 - On the Ground: If in doubt, stop, VERIFY POSITION, and contact ATC for assistance if necessary
 - In the Air: If the advisory is in conflict with expectations, VERIFY POSITION, contact ATC for assistance if necessary.
- Appropriate flight crew action to the non-routine RAAS advisories and cautions is as follows:

Annunciation	Expected Crew Response	Alert Level
Approaching Short Runway Advisory In Air (Landing): <i>“Approaching Runway XX, ZZ Available”</i>	Confirm aircraft position. Initiate/prepare for go-around if appropriate.	Advisory
Approaching Short Runway Caution In Air (Landing): <i>“Caution, Short Runway, Short Runway”</i>	Confirm aircraft position. Initiate/prepare for go-around if appropriate.	Caution
Taxiway Landing Caution: <i>“Caution, Taxiway!, Caution Taxiway!”</i>	Confirm aircraft position and initiate go-around if appropriate.	Caution
Insufficient Runway Length On Ground (Takeoff): <i>“On Runway XX, ZZ Remaining”</i>	Confirm aircraft position and that sufficient runway is available for take-off.	Advisory
Short Runway Caution On Ground (Takeoff): <i>“Caution, Short Runway Short Runway”</i>	Confirm aircraft position and discontinue takeoff if appropriate.	Caution
Taxiway Takeoff Advisory: <i>“On Taxiway! On Taxiway!”</i>	Confirm aircraft position and speed. Take necessary action as required (e.g. Abort, slow down or continue in case of approved taxiway take-off).	Advisory
Taxiway Takeoff Caution: <i>“Caution, On Taxiway! On Taxiway!”</i>	Confirm aircraft position and speed. Discontinue takeoff if appropriate.	Caution

- RAAS is not intended for navigation purposes. It provides short, discrete pieces of aural information designed to improve positional awareness and break the link in the sequence of events leading to runway incursions, but cannot be used to guide an aircraft in or around the terminal area.
- Information contained herein or provided by a RAAS callout does not supersede any operator Standard Operating Procedure (SOP).
- RAAS is not designed to enhance traffic awareness and therefore its use does not ensure protection for loss of separation with other traffic.
- The design of RAAS does not include knowledge of ATC clearance and/or flight crew intent, and therefore factors such as clearance misunderstandings; incorrect/inappropriate clearances cannot necessarily be mitigated by use of RAAS.
- RAAS does not include knowledge of prevailing Notice to Airmen (NOTAM) and therefore factors such as closure of runways are not reflected by advisories. Crews are assumed to be cognizant of prevailing NOTAM and Automatic Terminal Information Service (ATIS) data. Similarly, data on newly constructed runways or changes to length of existing runways may not necessarily be included in the RAAS runway database.
- Runway location data may have errors inherent in the source of such data. Such errors can delay an alert, or

Product Description – SmartRunway®/SmartLanding®

may cause unwanted alerts.

- RAAS callouts do not ensure that the aircraft will, or can be, stopped before hold lines, the runway edges or the runway end.
- RAAS distance advisories do not imply that the aircraft can or cannot be safely landed, stopped, or taken off from a runway.
- RAAS “On Taxiway” alerts do not insure that the aircraft is actually on a taxiway. For example, excessive ground speeds in areas such as ramps will also trigger the On Taxiway alert.
- RAAS in air “Approaching Runway” advisories do not ensure that the aircraft will land on the identified runway.
- The absence of an Approaching Runway In-Air advisory does not necessarily imply that the aircraft is approaching a surface other than a runway.
- RAAS may become Not Available at any time due to loss of accuracy of GPS signals.
- Other EGPWS aural alerts and warnings may preempt RAAS advisories. RAAS advisories may be issued during ATC radio communications, flight crew / cockpit communications, or during other aural messages provided in the cockpit by other aircraft systems.

5. Stabilized Approach Monitor

The Stabilized Approach Monitor is intended to inform the flight crew of awareness of unstabilized approaches and thus reduce landing risks and potential runway excursions.

5.1 Stabilized Approach Monitor Availability and Options

5.1.1 Stabilized Approach Monitor Operational Availability

Stabilized Approach Monitor function is operationally available anytime the EGPWS is powered and the following conditions are met:

- For MKV and MKVII EGPWS: Software Version 230-230 or later with a serial number EGPWC unit that has been enabled to use the functions described in this document (this is referred to as the ‘Enable Key being Set’), or EGPWS Software Version 965-1690-054 or later with the Enable Key Set, or 965-1676-004 or later with the Enable Key Set. For MKV-A EGPWS: software version 01.01 or later and Enable Key Set, or software version 51.01 or later and Enable Key Set. Refer to section 9.1 for more information on the Enable Key.

NOTE: Use of the Excessive Speed Monitor may require use of MKV-A EGPWS, or MKV/MKVII EGPWS Software Version 232-232, or 965-1690-055, or 965-1676-005 or later. Refer to Appendix G for more information.

- Terrain Database 454 or later. Note that a S/W mod may be required in order to use databases 456 and later – refer to section 4.1.1 for more information.
- The Stabilized Approach Monitor options have been loaded via an RCD into the EGPWC.
- Each enabled Stabilized Approach Monitor is functional (e.g. all external signals are available and not faulted and there are no internal EGPWC faults).
- For the Too High Function, the selected destination runway for the Runway Data (loaded as part of the Terrain Database) contains validated Runway elevations and endpoints.
- For the Too High Function, the selected destination runway is not indeterminate. Note: Indeterminate in this context refers to closely spaced parallel runways, where the approach ends of the runways are not adjacent, such that the distance from the aircraft to each runway’s threshold is significantly different.

Stabilized Approach Monitor Availability is integrated into the existing EGPWS fault monitoring and Self-Test functions.

- For software versions prior to 965-0976-236-236, 965-1676-006, and 965-1690-057, an Aircraft Type option via the RCD is available to drive the GPWS INOP visual with the Stabilized Approach Monitor status should this be required for a given design.
- For the MKV-A EGPWS, and MKV/MKVII EGPWS Software versions 965-0976-236-236, 965-1676-006, and 965-1690-057 and later:

The EGPWS also provides RAAS Monitor discrete output as well as ARINC 429 RAAS INOP and RAAS Not Available outputs.

The RAAS Monitor discrete will be active if any RCD enabled monitoring function (RAAS, Long Landing, Stabilized Approach, Altimeter, Takeoff Flap) becomes inoperative or not available. This discrete may be used to drive a dedicated RAAS INOP / Not Available lamp. Note to maintain backward compatibility that the system can be configured via the RCD to activate the GPWS INOP for RAAS INOP conditions.

The ARINC 429 RAAS INOP will be active if any RCD enabled monitor function becomes INOP. Similarly the ARINC 429 RAAS Not Available will become active if any RCD enabled monitor function is not available. If supported by Crew Alerting System (CAS) these labels may be used to drive dedicated RAAS INOP or RAAS Not Available CAS messages.

Product Description – SmartRunway®/SmartLanding®

Consistent with approved EGPWS Self-Test design, the loss of the Stabilized Approach Monitor function will be indicated on-ground during a level 1 Self-Test. Refer to Appendix C for a list of Self-Test maintenance messages.

5.1.2 EGPWS Runway Database

Current EGPWS databases contain airport and runway information. However, to ensure optimal Excessive Approach Angle Monitor performance, the accuracy of this data is re-verified and validated before the function can use the data. EGPWS Terrain database 454 and later contains additional airport and runway information that this monitor uses to determine if it can perform its intended function.

5.1.3 Signals Required

5.1.3.1 GPS Signals Required, Accuracy and Availability

Some of the Stabilized Approach Monitors require a high level of GPS position accuracy to function. GPS receivers used to provide position information must have a position resolution of 300 feet or better. Most ARINC 743/743A GPS systems provide this resolution. The internal GPS receivers used with the EGPWS provide the needed accuracy and resolution.

The Stabilized Approach Monitor does not require WAAS or Differential GPS (DGPS). However, either or both could enhance position accuracy of standard GPS data. The function monitors GPS accuracy and will automatically become Not Available if the accuracy degrades below acceptable limits. Factors which could degrade GPS accuracy include intentional accuracy degradation (Selective Availability activated), signal multipath, ionospheric and tropospheric delays, satellite geometry and shading, and system errors such as clock inaccuracies, etc.

5.1.3.2 Approach Speed

Approach Speed is required for the Excessive Approach Speed Monitor function. This data can come from displays or FMS, and must be configured to be received by the EGPWS aircraft type in order for the function to be enabled.

5.1.3.3 Other Required Signals

All other signals required for the Stabilized Approach Monitor are currently available from aircraft equipped with an EGPWS.

5.1.4 Stabilized Approach Monitor Options Summary

The option for a separate cockpit selection to inhibit the Stabilized Approach Monitor or to configure an existing cockpit selection (RAAS Inhibit) to inhibit the Stabilized Approach Monitor annunciations can be enabled via the RCD. The Stabilized Approach Monitor annunciations are single-shot and will only be activated in abnormal flight conditions.

Global Options are applicable for all Stabilized Approach Monitor advisories/cautions and will be the same for all aircraft types programmed in the RCD. For example, Stabilized Approach Monitor aural annunciations may be specified to be a Male or Female voice. If the Male voice is selected, all Stabilized Approach Monitor annunciations will use the Male voice. If one advisory is set to Male, another cannot be set to Female.

Aircraft-Type Specific options can be selected differently between various aircraft types specified in the RCD. The following table indicates which options are global and which are aircraft specific.

Table 5-1: Stabilized Approach Monitor Options

DESCRIPTION	Global Option	A/C Type Specific Option	SELECTIONS	REF SECTION
Voice Gender	X		MALE, FEMALE	3.1
Enable/Inhibit Discrete	X		NONE, INHIBIT, ENABLE	See above
Landing Flap Monitor – Upper Gate		X	OFF, ON, Upper Limit Altitude (AFE)	5.2.1
Landing Flap Monitor – Lower Gate		X	OFF, ON, Upper Limit Altitude (AFE)	5.2.1
Excessive Approach Angle Monitor	X		OFF, ON	5.2.2
Excessive Approach Speed Monitor	X		OFF, ON	5.2.3
Unstable Monitor	-	-	No Option. If any of the above Monitors are enabled, then 'Unstable' is enabled.	5.2.4
Enable Visual Messages on Terrain Display	X		NONE, ALL, NON-ROUTINE ONLY, CAUTIONS ONLY	9.3

5.2 Stabilized Approach Monitor Sub-Monitors

5.2.1 Landing Flap Monitor

The purpose of the Landing Flap annunciation is to provide the flight crew with awareness of a possible unstabilized approach due to Flaps not in landing configuration.

The annunciations generated from the Landing Flap Monitor are classified as advisory level as crew awareness is required and may require subsequent flight crew response.

5.2.1.1 Annunciation Criteria

This function provides a “Flaps (pause) Flaps” aural annunciation if the landing flaps are not set at 950 ft AFE (typical). A “Flaps-Flaps” (no pause in between) aural annunciation is provided if the aircraft is aligned with the runway and the landing flaps are still not set at 600 ft AFE (typical).

Although the existing EGPWS Mode 4 envelope already provides a landing flaps annunciation (i.e., “Too Low Flaps” annunciation at 245 ft radio altitude), many operators prefer to be advised at much higher altitude from a stabilized approach point of view. Therefore, Stabilized Approach Monitor is designed to provide a landing flaps annunciation independent from Mode 4. If the landing flaps monitor is not necessary for an operator’s flight operation, the function would not be enabled in the RCD.

According to pilots from several major airlines who fly large air transport jets in the U.S., Europe and Asia, the landing flaps are typically set before the aircraft reaches 1,000 feet AGL except during a circling approach. The landing flaps are not set until the aircraft is on base during a circling approach. Since the Stabilized Approach Monitor function does not know the destination runway set in the FMS, the function can issue a “Flaps (pause) Flaps” annunciation during a circling approach, most likely on the downwind leg. If this becomes an issue, this portion of the function can be disabled by the RCD.

Figure 5-1 provides a high level view of the Landing Flap Monitor function.

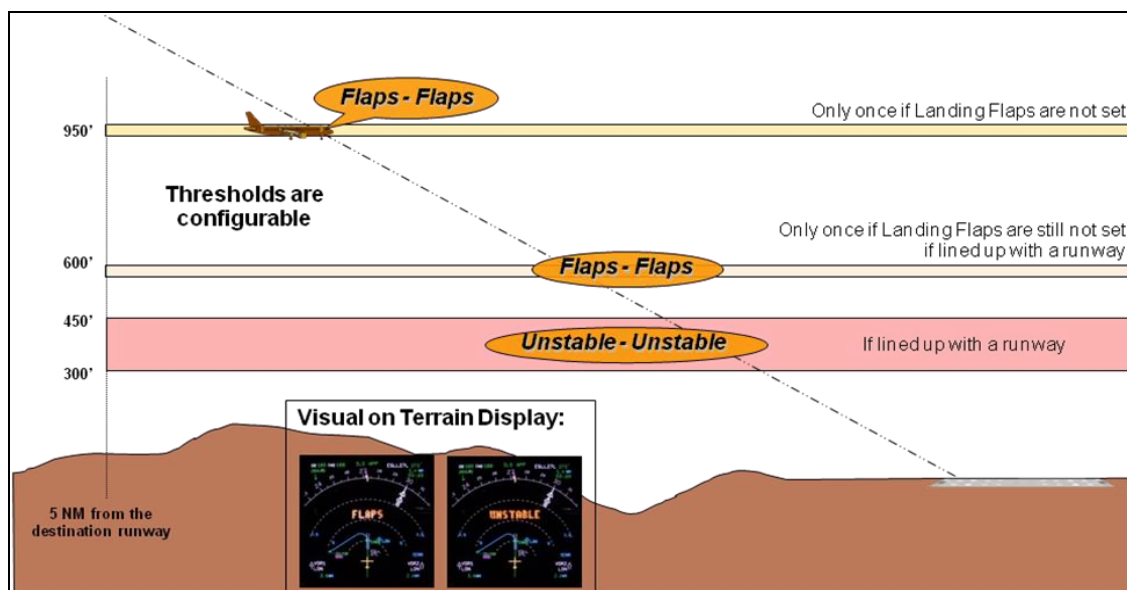

Figure 5-1: Landing Flap Monitor

The Stabilized Approach Monitor enable logic uses the following inputs: Distance to Runway End (from Runway Database), Destination Runway (computed based on aircraft position Latitude and Longitude), In Air (computed based on Radio Altitude and Computed Airspeed), and Altitude Rate (IVS or ADC).

The Landing Flap Monitor function uses the following inputs: Landing Flap, Altitude Rate (IVS or ADC), Distance to Runway End (from Runway Database), and Height Above Field (from Runway Database).

Product Description – SmartRunway®/SmartLanding®

Typically most aircraft equipped with an EGPWS provide the signals required for this monitor with no additional system or wiring changes required.

The first Landing Flap Monitor annunciation is generated when the following conditions are met:

- First Landing Flap Monitor is enabled via the RCD, and
- Flaps are not in landing configuration, and
- Height Above Field Elevation is less than or equal to 950 feet (typical).

The second Landing Flap Monitor annunciation is generated when the following conditions are met:

- Second Landing Flap Monitor is enabled via the RCD, and
- Flaps are not in landing configuration, and
- Height Above Field Elevation is less than or equal to 600 feet (typical), and
- Aircraft is lined up with a runway (aircraft is within approximately 3 nautical miles of the runway and aircraft track is aligned with the runway within ± 20 degrees).

5.2.1.2 Message Content

The aural message consists of the phrase “*Flaps (pause) Flaps*” and is issued once for the initial entry into the envelope when flaps are not in landing configuration and the aircraft is not aligned with the runway. The phrase “*Flaps-Flaps*” is issued once when flaps are not in landing configuration and the aircraft is aligned with the runway.

5.2.1.3 Audio Level

By default, the aural message is generated at the EGPWS Warning volume level. The volume level may be adjusted to a different level using the RCD.

5.2.1.4 Visuals

Since this annunciation is considered an advisory, a visual is optional. If configured to do so, the EGPWS presents the text string “FLAPS” overlaid on top of the terrain image upon activation of the aural. The text is amber in color and centered on the display. Figure 5-1 provides an example of the EGPWS generated terrain overlay.

The text will remain on the display until any one of the following conditions exists: configured timer expires (default is 16 seconds), range on the terrain display is changed, a new voice with associated visual annunciation is issued, a Terrain/Obstacle caution or warning condition exists, or Height Above Field (AFE) is less than or equal to 300 feet.

The visual annunciation may be enabled or disabled via the RCD.

5.2.2 Excessive Approach Angle Monitor

The purpose of the Excessive Approach Angle Monitor annunciation is to provide the flight crew with awareness of a possible unstabilized approach if the approach angle to the destination runway becomes too steep.

The annunciations generated from the Approach Angle monitor are classified as advisory level as crew awareness is required and may require subsequent flight crew response.

5.2.2.1 Annunciation Criteria

This function provides a “*Too High-Too High*” annunciation if the approach angle to the runway becomes too steep.

The aircraft must be lined up with the destination runway on final approach to enable this function. When a circling approach is flown, the aircraft can fly over the runway on downwind leg, which makes the computed angle to the runway very large. Therefore, the Excessive Approach Angle Monitor is not enabled until 600 ft AFE (minimum circling minima) unless the aircraft is fully configured to land. The destination runway must be identified with very high likelihood and the runway location must be validated for this function to be enabled for a given runway. The aircraft position must also be accurate, thus requiring a direct GPS connection.

Note that there is an effective 450 foot lower limit where the unstable voice would take precedence.

If the excessive approach angle monitor is not necessary for an operator’s flight operation, the function can be disabled by the RCD.

Figure 5-2 provides a high level view of the Excessive Approach Angle Monitor function.

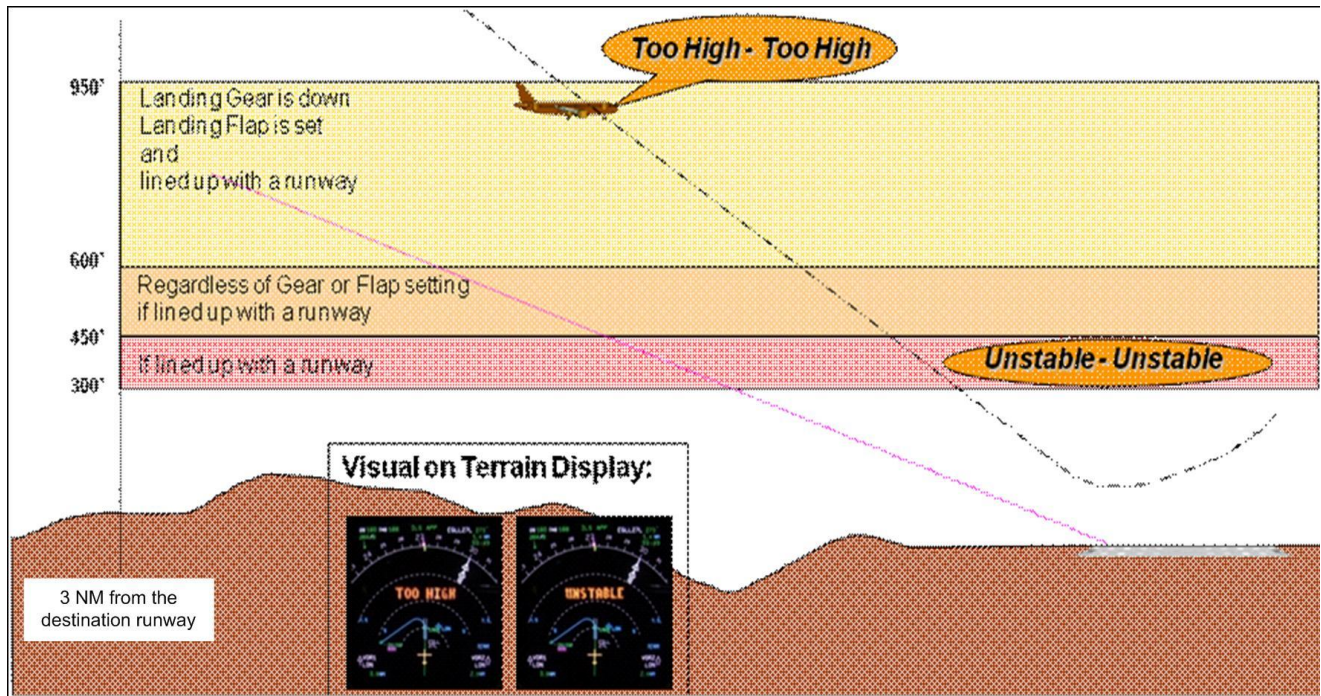

Figure 5-2: Excessive Approach Angle Monitor

As illustrated in Figure 5-3, the Too High alert may be enabled at a different distance than other Stabilized Approach Monitor alerts.

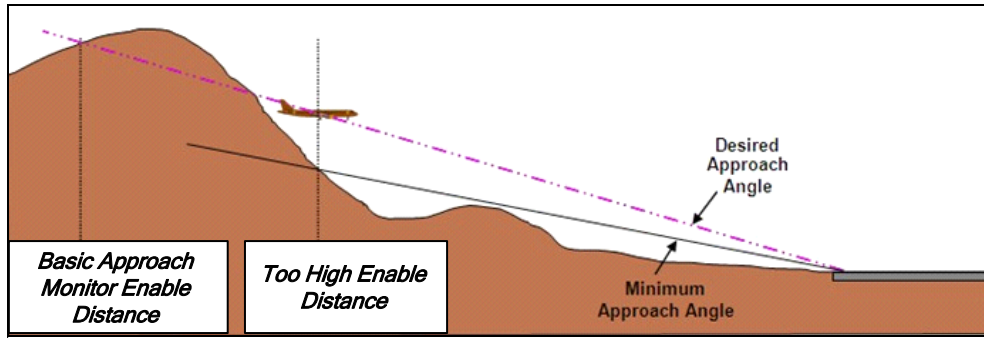

Figure 5-3: Approach Monitor Too High Enable Distance

The envelope shown in Figure 5-4 is for a runway whose desired approach angle is 3-degree (i.e., 3° glideslope or 3° PAPI). This envelope can be represented on a more intuitive Height-Distance plot as in Figure 5-5.

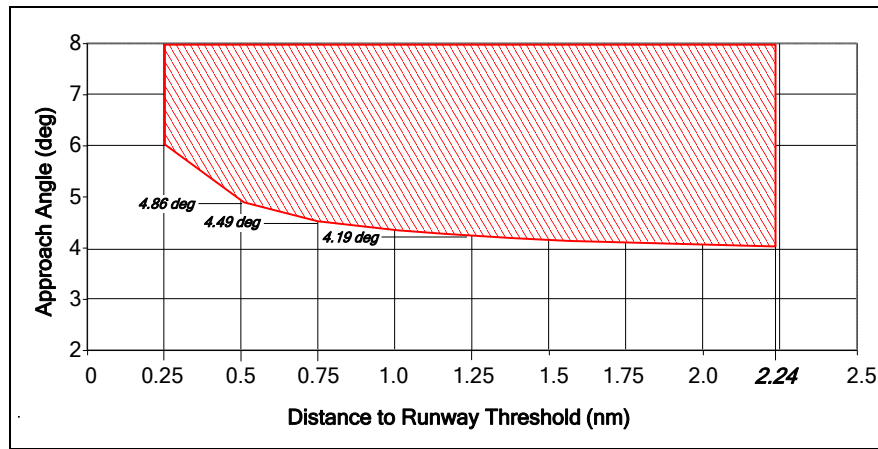

Figure 5-4: Excessive Approach Angle Envelope

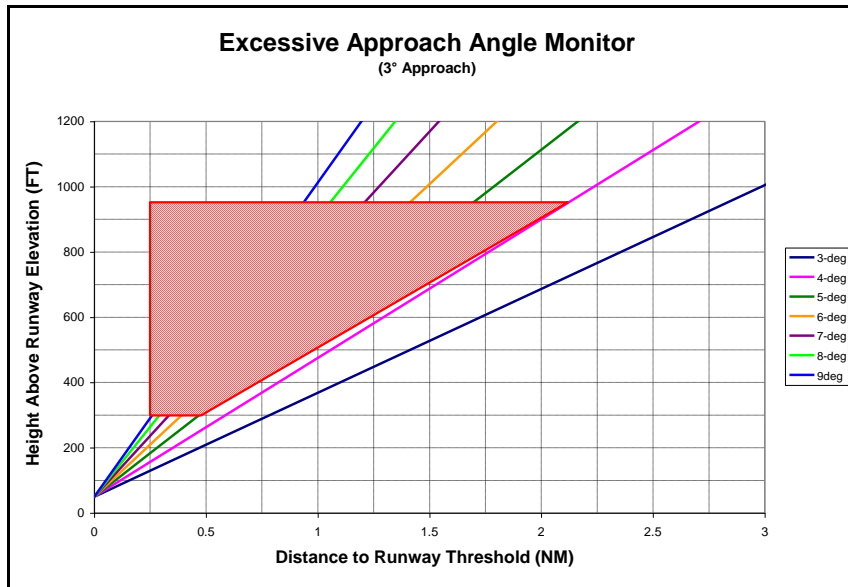

Figure 5-5: Excessive Approach Angle Monitor Curves (3° Approach)

The Stabilized Approach Monitor enable logic uses the following inputs: Distance to Runway End (from Runway Database), Destination Runway (computed based on aircraft position Latitude and Longitude), In Air (computed based on Radio Altitude and Computed Airspeed), and Altitude Rate (IVS or ADC).

Product Description – SmartRunway®/SmartLanding®

The Excessive Approach Angle Monitor function uses the following inputs: Landing Gear, Landing Flap, Altitude Rate (IVS or ADC), Glideslope, Localizer, Glideslope Angle to Runway End (from Runway Database), Distance to Runway End (from Runway Database), Height Above Field (from Runway Database), and position uncertainty (computed based on aircraft position and accuracy of position source).

Typically most aircraft equipped with an EGPWS provide the signals required for this monitor with no additional system or wiring changes required.

The Excessive Approach Angle Monitor annunciation is generated when all of the following conditions are met.

- Excessive Approach Angle Monitor is enabled via the RCD, and
- Height Above Field Elevation is less than or equal 950 feet (default) with gear and flaps in landing configuration OR Height Above Field Elevation is less than or equal 600 feet (default) regardless of gear and flap configuration, and
- Aircraft is lined up with a runway (aircraft is within approximately 3 nautical miles of the runway and aircraft track is aligned with the runway within ± 20 degrees), and
- Position uncertainty is less than 0.02 NM (accurate position), and
- Geometric Altitude Vertical Figure of Merit (VFOM) is less than 150 feet (accurate altitude), and
- Destination Runway Position data Quality is high, and
- If ILS is present (tuned and valid), then Glideslope Deviation must be more than 2 dots **or** Localizer Deviation must be more than 1 dot, and
- Distance to runway end and the current approach angle to the runway end violate the Excessive Approach Angle curve.
- The selected destination runway is not indeterminate. Note: Indeterminate in this context refers to closely spaced parallel runways, where the approach ends of the runways are not adjacent, such that the distance from the aircraft to each the runway's threshold is significantly different.

The excessive approach angle curve uses the nominal glideslope angle to runway end from the runway database to accommodate airports with steeper than typical approach angles.

5.2.2.2 Message Content

The aural message consists of the phrase *“Too High-Too High”* and is issued once when the aircraft meets the conditions described in section 5.2.2.1.

5.2.2.3 Audio Level

By default, the aural message is generated at the EGPWS Warning volume level. The volume level may be adjusted to a different level using the RCD.

5.2.2.4 Visuals

Since this annunciation is considered an advisory, a visual is optional. If configured to do so, the EGPWS presents the text string *“TOO HIGH”* overlaid on top of the terrain image upon activation of the aural. The text is amber in color and centered on the display. Figure 5-2 provides an example of the EGPWS generated terrain overlay.

The text will remain on the display until any one of the following conditions exists: configured timer expires (default is 16 seconds), range on the terrain display is changed, a new voice with associated visual annunciation is issued, a Terrain/Obstacle caution or warning condition exists, or Height Above Field (AFE) is less than or equal to 300 feet.

The visual annunciation may be enabled or disabled via the RCD.

5.2.3 Excessive Approach Speed Monitor

Important note: To use the Stabilized Approach Monitor's Excessive Speed Alert, the EGPWS must have a source of Approach or Reference Speed. For some aircraft, this means adding additional wiring to connect to an ARINC 429 source for this data. Refer to Appendix G for a list of EGPWS aircraft types that can select the Excessive Speed Monitor. This monitor can NOT be selected if the installation uses the MKVII EGPWS.

The purpose of the Excessive Approach Speed Monitor annunciation is to provide the flight crew with awareness of a possible unstabilized approach due to excessive approach speeds.

The annunciations generated from the Approach Speed monitor are classified as advisory level as crew awareness is required and may require subsequent flight crew response.

5.2.3.1 Annunciation Criteria

This function provides a “Too Fast-Too Fast” annunciation if the aircraft approach speed becomes too fast compared to the target approach speed (V_{ref} or V_{app}). Since pilots are often asked by ATC to maintain high speed during the final approach, the excessive speed envelope is designed to allow greater deviation from the target approach speed at higher altitude.

When a circling approach is flown, the aircraft speed remains high on the downwind leg. Therefore, Excessive Speed Monitor is not enabled until 600 ft AFE unless the aircraft is fully configured to land, which indicates the aircraft is committed to land. Note that there is an effective 450 foot lower limit where the unstable voice, if enabled, would take precedence.

V_{ref} is typically the stall speed multiplied by 1.3. For an Airbus FMGC, V_{app} is V_{LS} (Airbus equivalent of V_{ref}) plus additional factors such as wind and gust. Because V_{app} on Airbus already has wind and gust factors added, the Excessive Speed Monitor Envelope for Airbus aircraft will be different from one for Boeing aircraft using V_{ref} , and can be set more sensitive. Other aircraft, besides Boeing and Airbus, tend to provide V_{ref} .

If the excessive approach speed monitor is not necessary for an operator’s flight operation, the function can be disabled by the RCD.

Figure 5-6 provides a high level view of the Excessive Approach Speed Monitor function. See Figure 5-7 for a view of the Excessive Speed Monitor envelopes.

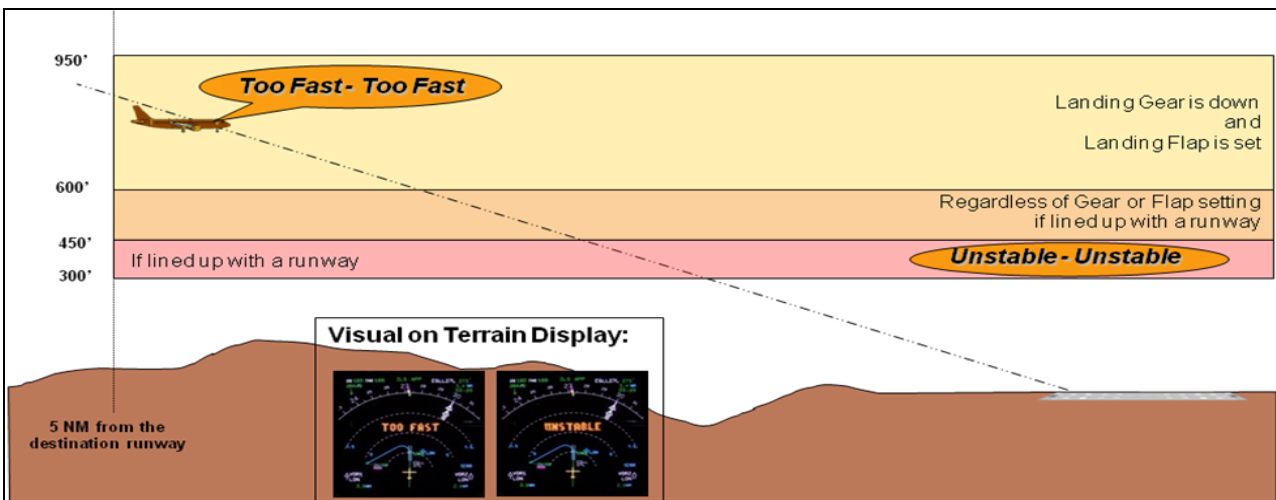

Figure 5-6: Excessive Approach Speed Monitor

Product Description – SmartRunway®/SmartLanding®

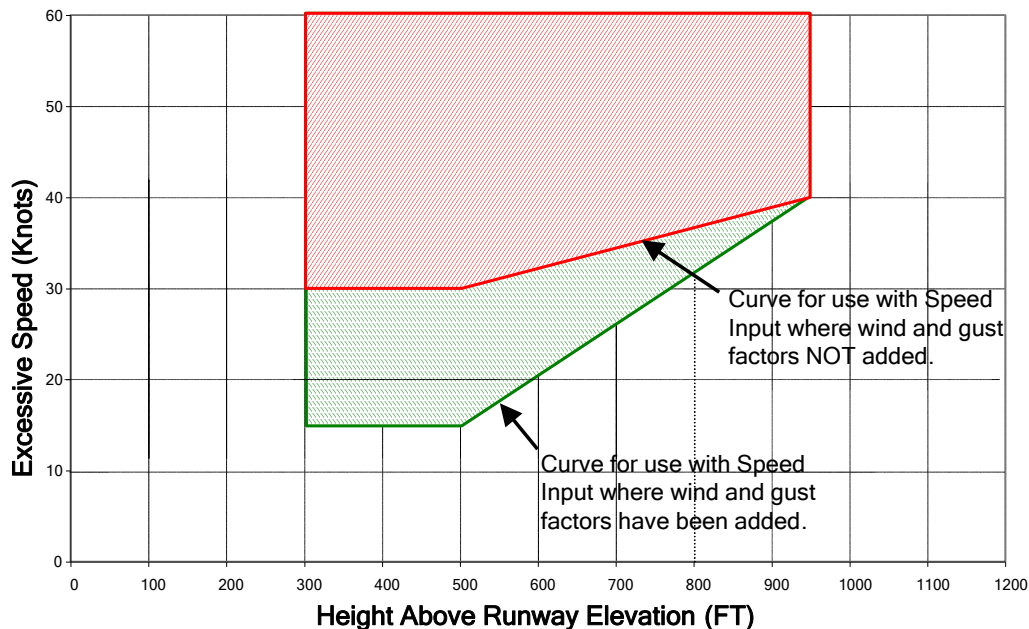

Figure 5-7: Excessive Speed Monitor Envelope

The Stabilized Approach Monitor enable logic uses the following inputs: Distance to Runway End (from Runway Database), Destination Runway (computed based on aircraft position Latitude and Longitude), In Air (computed based on Radio Altitude and Computed Airspeed), and Altitude Rate (IVS or ADC).

The Excessive Approach Speed Monitor function uses the following inputs: Landing Gear, Landing Flap, Computed Airspeed, In Air, Approach Speed (V_{ref}/V_{app}), Distance to Runway End (from Runway Database), and Height Above Field (from Runway Database).

Typically most aircraft equipped with an EGPWS provide the signals required for this monitor, except for V_{ref} . This may require a system or wiring change.

The Excessive Approach Speed Monitor annunciation is generated when all of the following conditions are met.

- Excessive Approach Speed Monitor is enabled via the RCD, and
- Height Above Field Elevation is less than or equal to 950 feet (default) with gear and flaps in landing configuration
OR
Height Above Field Elevation is less than or equal to 600 feet (default) regardless of gear and flap configuration if Aircraft is lined up with a runway (aircraft is within approximately 3 nautical miles of the runway and aircraft track is aligned with the runway within ± 20 degrees), and
- Height Above Field Elevation and Excessive Speed (Computed Airspeed minus Approach Speed (V_{ref} or V_{app})) violate the Excessive Speed curve.

5.2.3.2 Message Content

The aural message consists of the phrase “*Too Fast-Too Fast*” and is issued once when the aircraft meets the conditions described in section 5.2.3.1.

5.2.3.3 Audio Level

By default, the aural message is generated at the EGPWS Warning volume level. The volume level may be adjusted to a different level using the RCD.

5.2.3.4 Visuals

Since this annunciation is considered an advisory, a visual is optional. If configured to do so, the EGPWS presents the text string “TOO FAST” overlaid on top of the terrain image upon activation of the aural. The text is amber in color and centered on the display. Figure 5-6 provides an example of the EGPWS generated terrain overlay.

The text will remain on the display until any one of the following conditions exists: configured timer expires (default is 16 seconds), range on the terrain display is changed, a new voice with associated visual annunciation is issued, a Terrain/Obstacle caution or warning condition exists, or Height Above Field (AFE) is less than or equal to 300 feet.

The visual annunciation may be enabled or disabled via the RCD.

5.2.4 Unstable Approach Monitor

The purpose of the Unstable Approach Monitor annunciation is to provide the flight crew with awareness of a possible unstabilized approach.

The annunciations generated from the Unstable Approach monitor are classified as caution level as crew awareness is required and subsequent flight crew response is required.

5.2.4.1 Annunciation Criteria

This function provides an “Unstable-Unstable” annunciation if the aircraft has not been stabilized by the “450 ft Gate”. Figure 5-8 provides a high level view of the Unstable Approach function. The figure includes the possible triggers that can lead to activation of the unstable annunciation.

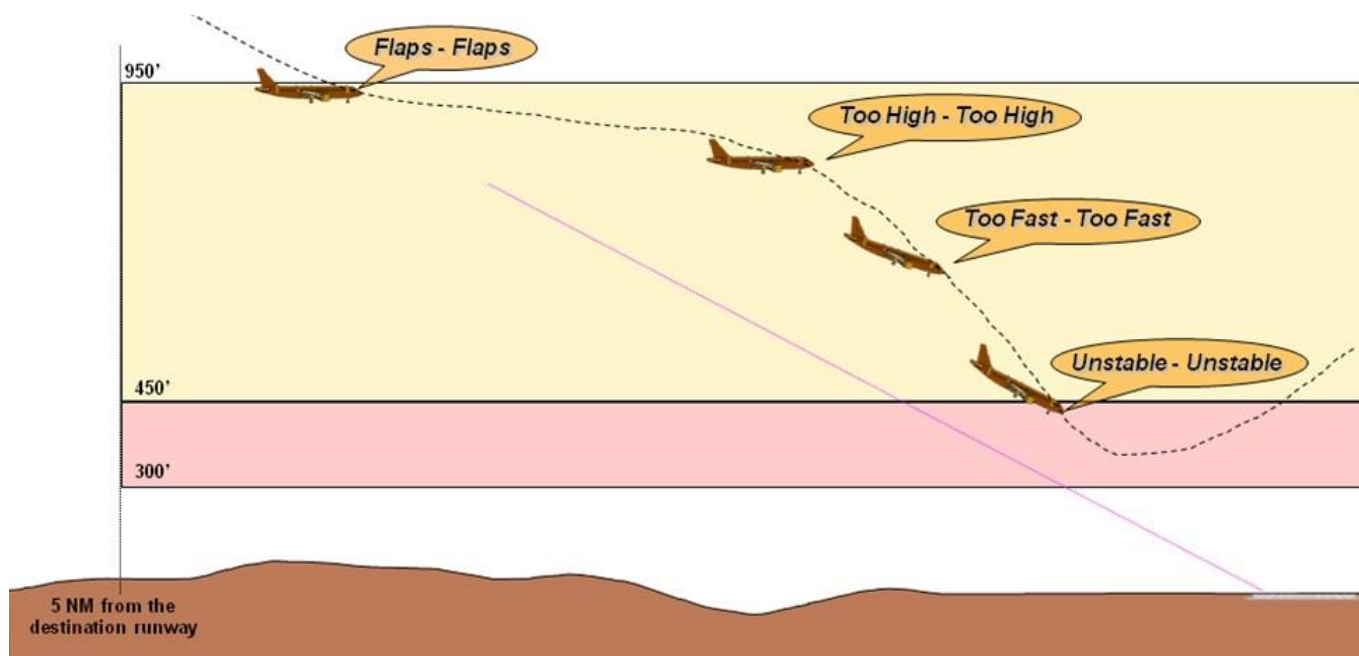

Figure 5-8: Stabilized Approach Monitor

The Stabilized Approach Monitor enable logic uses the following inputs: Distance to Runway End (from Runway Database), Destination Runway (computed based on aircraft position Latitude and Longitude), In Air (computed based on Radio Altitude and Computed Airspeed), and Altitude Rate (IVS or ADC).

The Unstable Approach Monitor function uses the following inputs: Landing Gear, Landing Flap, Altitude Rate (IVS or ADC), Distance to Runway End (from Runway Database), and Height Above Field (from Runway Database).

Typically most aircraft equipped with an EGPWS provide the signals required for this monitor with no additional system or wiring changes required.

Product Description – SmartRunway®/SmartLanding®

The Unstable Approach Monitor annunciation is generated when all of the following conditions are met.

- Height Above Field Elevation is less than or equal 450 feet (default) and greater than 300 feet (default), and
- One of the Approach Monitor triggers has been annunciated (Landing Flap Monitor, Excessive Approach Angle Monitor, or Excessive Approach Speed Monitor).

As shown above, the Unstable Approach annunciation will not be provided until after one of the other Stabilized Approach Monitor annunciations has been issued.

5.2.4.2 Message Content

The aural message consists of the phrase “*Unstable-Unstable*” and is issued once if the aircraft has not been stabilized by 450 feet AFE as described in section 5.2.4.1

5.2.4.3 Audio Level

By default, the aural message is generated at the EGPWS Warning volume level. The volume level may be adjusted to a different level using the RCD.

5.2.4.4 Visuals

This annunciation is considered a caution, so a visual indication is required when an aural annunciation is activated. The function is configured, by default, to provide illumination of an existing EGPWS cockpit lamp and present the text string “UNSTABLE” overlaid on top of the terrain image upon activation of the aural. Configuration options allow the function to drive either the lamp or visual annunciation on the Terrain Display, both, or neither. If the cockpit lamp option is selected the caution lamp is illuminated upon activation of the annunciation and stays active as long as the unstable condition exists. Figure 5-9 shows an example of a typical lamp interface. If the terrain display option is selected, the text is amber in color and centered on the display. Several of the figures in the previous Approach Monitor sections have examples of the EGPWS generated terrain overlay for ‘Unstable’.

The text on the terrain display will remain on the display until any one of the following conditions exists: configured timer expires (default is 16 seconds), range on the terrain display is changed, a new voice with associated visual annunciation is issued, a Terrain/Obstacle caution or warning condition exists, or Height Above Field (AFE) is less than or equal to 300 feet.

The visual annunciations may be enabled or disabled via the RCD.

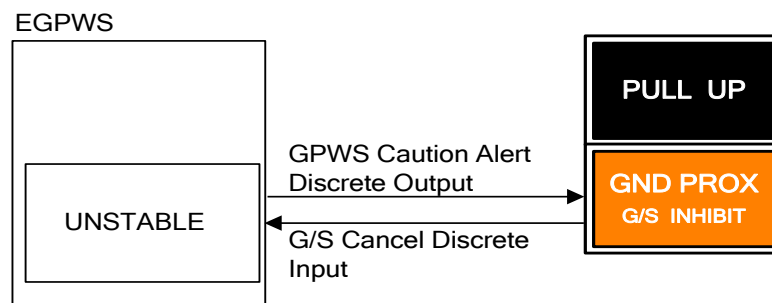

Figure 5-9: Lamp Visual (Activated for Unstable Approach Annunciation)

5.3 Assumptions, Limitations and Constraints

- Honeywell’s Stabilized Approach Monitor provides both advisory and caution annunciations. Advisories are for conditions that require flight crew awareness and may require subsequent flight crew response. Cautions are for conditions that require immediate flight crew awareness and subsequent flight crew response.
- Appropriate flight crew action is as follows:

Annunciation	Expected Crew Response	Alert Level
<i>Flaps (pause) Flaps</i> (in air at 950 ft AFE) <i>Flaps-Flaps</i> (in air at 600 ft AFE)	Verify flap position and select flap as required.	Advisory
<i>Too High-Too High</i>	Verify vertical position, apply corrections as required.	Advisory
<i>Too Fast-Too Fast</i>	Verify airspeed and adjust as necessary.	Advisory
<i>Unstable-Unstable</i> (Flap 450–300ft AFE) (Too High 450–300ft AFE) (Too Fast 450–300ft AFE)	Verify whether approach parameters are as expected/briefed and take appropriate action as necessary.	Caution

- Information contained herein or provided by a Stabilized Approach Monitor annunciation does not supersede any operator Standard Operating Procedure (SOP).
- Runway location data may have errors inherent in the source of such data. Such errors can delay an alert, or may cause unwanted alerts.
- The Stabilized Approach Monitors may become Not Available at any time due to loss of accuracy of GPS signals.
- Other EGPWS aural alerts may preempt Stabilized Approach Monitor annunciations. Stabilized Approach Monitor annunciations may be issued during ATC radio communications, flight crew / cockpit communications, or during other aural messages provided in the cockpit by other aircraft systems.

6. Altimeter Monitor

The Altimeter Monitor provides the flight crew with two advisories that inform of improper altimeter setting. One monitor detects altimeter setting errors while the aircraft is below the transition altitude and the second detects if the altimeter has not be set to the standard altitude when the aircraft climbs above the transition altitude.

6.1 Altimeter Monitor Availability and Options

The Altimeter Monitor is operationally available anytime the EGPWS is powered and the following conditions are met:

- For MKV/MKVII EGPWS: Software Version 230-230 or later with a serial number EGPWC unit that has been enabled to use the functions described in this document (this is referred to as the ‘Enable Key being Set’), or EGPWS Software Version 965-1690-054 or later with the Enable Key Set, or 965-1676-004 or later with the Enable Key Set. For MKV-A EGPWS: software version 01.01 or later and Enable Key Set, or software version 51.01 or later and Enable Key Set. Refer to section 9.1 for more information on the Enable Key.
- Terrain Database 435 or later.
- The Altimeter Monitor options have been loaded via an RCD into the EGPWC.
- The selected destination runway for the Runway Data (loaded as part of the Terrain Database) contains a valid Transition Altitude, or the height above the selected runway is less than 1,500 feet.
- For the below transition altitude monitor the aircraft is not operating under QFE conditions. The EGPWS is not configured for QFE operations, the selected Barometric Reference (if available to the EGPWS) is not set to QFE, and the selected destination runway is not indicated as a QFE runway.

Note 1: Some AIRBUS aircraft provide the EGPWS with a Barometric Altitude Reference selection. If this selection is set to QFE the Altimeter Monitor will be automatically inhibited.

Note 2: Airport runways in Russia and China that are designated for QFE operation are noted in the Terrain/Runway database. The Altimeter Monitor will be automatically inhibited at these airport runways.

For MKV-A EGPWS, and MKV/MKVII EGPWS Software Version 965-0976-236-236, 965-1676-006, and 965-1690-057 and later:

Some customers operating at QFE airports fly the approaches with their altimeters set to QNH and want Altimeter Monitor to be active and available. An option was added to override the QFE disabling of Altimeter Monitor function when the EGPWS detects the approach is to a QFE runway. This option will not override QFE disabling due to Barometric Altitude Reference being set to QFE or selection of QFE input.

- The required input signals are valid and reasonable. Required inputs signals include corrected pressure altitude, uncorrected pressure altitude, and static air temperature from the ADC, GPS Altitude, accuracy, and integrity data from the GPS receiver, radio altitude, and roll angle.

Altimeter Monitor Availability is integrated into the existing EGPWS fault monitoring and Self-Test functions.

- For software versions prior to 965-0976-236-236, 965-1676-006, and 965-1690-057, the operational status is not provided by the existing GPWS and TAD status output.
- For MKV-A EGPWS, and MKV/MKVII EGPWS Software versions 965-0976-236-236, 965-1676-006, and 965-1690-057 and later:

The EGPWS also provides a RAAS Monitor discrete output as well as ARINC 429 RAAS INOP and RAAS Not Available outputs.

Product Description – SmartRunway®/SmartLanding®

The RAAS Monitor discrete will be active if any RCD enabled monitoring function (RAAS, Long Landing, Stabilized Approach, Altimeter, Takeoff Flap) becomes inoperative or not available. This discrete may be used to drive a dedicated RAAS INOP / Not Available lamp. Note to maintain backward compatibility that the system can be configured via the RCD to activate the GPWS INOP for RAAS INOP conditions.

The ARINC 429 RAAS INOP will be active if any RCD enabled monitor function becomes INOP. Similarly the ARINC 429 RAAS Not Available will become active if any RCD enabled monitor function is not available. If supported by Crew Alerting System (CAS) these labels may be used to drive dedicated RAAS INOP or RAAS Not Available CAS messages.

Option to include QFE approach in the Not Available logic. If the option is selected and the EGPWS detects that the approach is to a QFE runway then the Altimeter Monitor function will be set to Not Available.

Consistent with approved EGPWS Self-Test design, the status of the Altimeter Monitor function will be indicated on-ground during a level 1 Self-Test. Refer to Appendix D for a list of Self-Test maintenance messages.

For software versions prior to 965-0976-236-236, 965-1676-006, and 965-1690-057:

The option for a cockpit selection to inhibit the Altimeter Monitor annunciations was not available. Due to the nature of this message and the inputs which are monitored, it was determined that an option to inhibit these annunciations was not required.

For MKV-A EGPWS and MKV/MKVII Software versions 965-0976-236-236, 965-1676-006, and 965-1690-057 and later:

The option to inhibit the Altimeter Monitor annunciations was added. The inhibit option allows for inhibiting via the RAAS inhibit or Stabilized Approach Monitor inhibit cockpit switch.

All Altimeter Monitor Options are global. In other words, all aircraft types defined in the RCD function the same with respect to the Altimeter Monitor.

Table 6-1: Altimeter Monitor Options

DESCRIPTION	Global Option	A/C Type Specific Option	SELECTIONS	REF SECTION
Voice Gender	X		MALE,FEMALE	3.1
Below Transition Altitude Monitor	X		OFF, ON	6.2.1
Above Transition Altitude Monitor	X		OFF, ON	6.2.2
Enable Visual Messages on Terrain Display	X		NONE, ALL, NON-ROUTINE ONLY, CAUTIONS ONLY (Altimeter Monitor is not a caution)	9.3
Altimeter Monitor Enable/Inhibit	X		NONE, EQUAL TO RAAS INH DISCRETE, EQUAL TO Stabilized Approach Monitor INHIBIT DISCRETE	6.1
QFE Runway Override	X		OFF, ON	6.2.1
Destination runway is QFE then Altimeter Monitor Not Available output is set true	X		OFF, ON	6.1

6.2 Altimeter Monitor Sub-Monitors

6.2.1 Below Transition Altitude Monitor

The purpose of this monitor is to provide the flight crew with awareness of improper corrected altitude setting while operating below the transition altitude.

The annunciation generated from this monitor is classified as an advisory level as crew awareness may be required and crew response is not necessarily imminent.

6.2.1.1 Annunciation Criteria

The EGPWS compares Corrected Altitude from the Air Data Computer (ADC) with the Global Positioning System (GPS) Altitude from the GPS receiver. If the difference between the two altitudes exceeds a computed threshold value an Altimeter Setting aural message and an optional visual annunciation are generated. Note that the EGPWS does not perform a cross check of both Air Data inputs because if the pilot's side data and co-pilot's side data are different, a function external to the EGPWS provides an indication to the crew. Therefore the EGPWS compares Corrected Altitude with GPS Altitude from the pilot's side data only. The advisory threshold is dynamically computed based on estimated errors due to non-standard atmospheric conditions, current GPS accuracy, and Air Data system errors. Since the threshold is dynamic, the size of the error that can be detected varies with the current aircraft state and sensor conditions. The figure below shows the size of errors that can be detected for typical conditions as function of the aircraft height above field for different ISA temperature deviations.

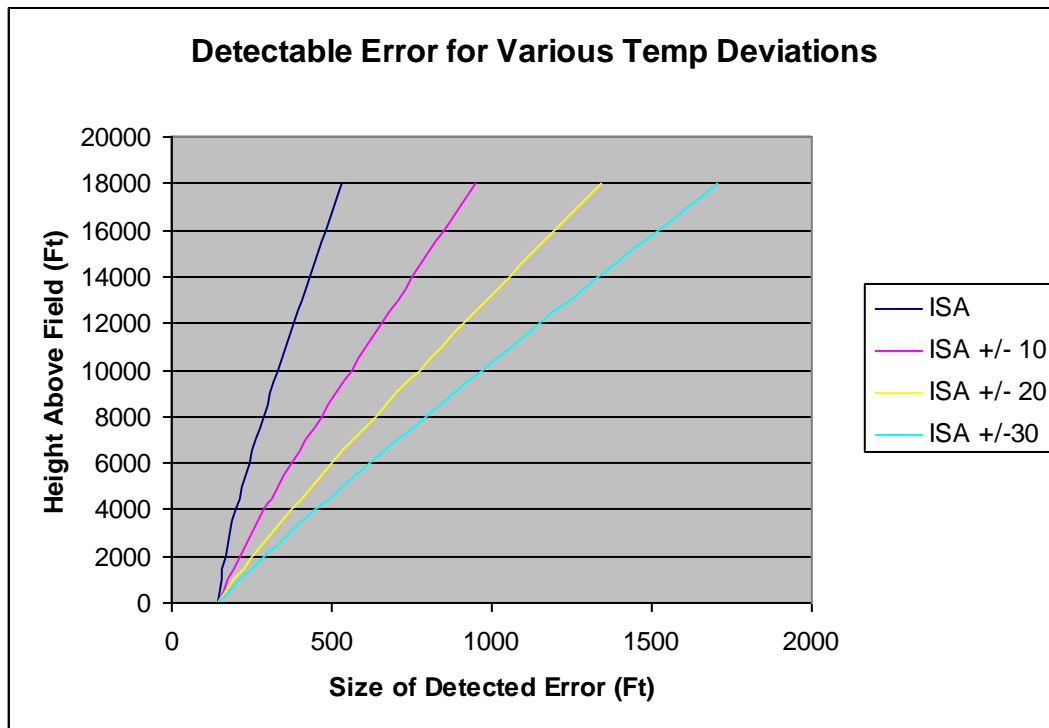

Figure 6-1: Altimeter Monitor Detectable Error

The Altimeter Monitor includes a cross check on the GPS Altitude to prevent nuisance advisories caused by erroneous GPS Altitude values. The cross-check compares GPS Altitude with aircraft altitude computed using radio altitude and the terrain elevation from the terrain database. The difference between these altitudes is compared against a dynamically computed threshold based on the current GPS accuracy, radio altitude accuracy, and the estimated terrain database accuracy. If the cross-check fails, then the Below Transition Altitude Monitor is disabled to prevent nuisance annunciations caused by erroneous GPS Altitude values.

Product Description – SmartRunway®/SmartLanding®

The Altimeter Monitor uses the following inputs: GPS data (including Altitude, Vertical Figure of Merit, Non-Isolatable Satellite Failure (NISF), Horizontal Integrity Limit, Number of Satellites, and Operating Mode), and ADC data (Corrected Barometric Altitude, Pressure Altitude, and Static Air Temperature).

Typically most aircraft equipped with an EGPWS provide the signals required for this monitor with no additional system or wiring changes required.

The Below Transition Altitude Monitor annunciation is generated when the following conditions are met:

- GPS Altitude and Vertical Figure of Merit (VFOM) are valid and have passed internal reasonableness checks
- GPS is not in altitude aiding mode, the number of satellites tracked is 5 or greater, a non-isolatable satellite failure (NISF) does not exist, and GPS Horizontal Integrity Limit (HIL) is valid
- Corrected Barometric Altitude and Static Air Temperature are valid
- EGPWS Runway Database is valid
- Aircraft Altitude is less than the Transition Altitude for more than 30 seconds OR Height Above Field is less than 1500 feet. The transition altitude is obtained from the EGPWS runway database for the destination runway.
- Aircraft is within 20 nautical miles of the EGPWS Selected destination runway
- Height above field is less than 5000 feet
- For software versions prior to 965-0976-236-236, 965-1676-006, and 965-1690-057:

Airport is not indicated as QFE, altimeter setting is not QFE, and QFE program pin is not selected

For MKV-A EGPWS, and MKV/MKVII EGPWS Software versions 965-0976-236-236, 965-1676-006, and 965-1690-057 and later:

Airport is not indicated as QFE or a QFE override option is selected, altimeter setting is not QFE, and QFE program pin is not selected

Note: The RCD QFE Override option should only be selected if aircraft is certified to perform non-QFE approaches at QFE destinations.

- Radio Height is greater than 600 feet
- The filtered difference between Corrected Altitude and GPS Altitude exceeds a threshold computed based on the current estimated altimetry system errors

6.2.1.2 Message Content

The aural message consists of the phrase “*Altimeter Setting*”. This advisory is issued once when the altimeter error is first detected and will repeat once, 8 seconds later. After two voice messages, no additional messages will be generated.

The advisory will be re-armed if the enable logic goes false and then true or after a change in the altimeter setting is detected by the EGPWS.

6.2.1.3 Audio Level

By default, the aural message is generated at the EGPWS Warning volume, but the audio level may be adjusted to a different level using the RCD.

6.2.1.4 Visuals

Since this annunciation is considered an advisory, a visual is optional. If configured to do so, the EGPWS presents the text string “ALTM SETTING” overlaid on top of the terrain image upon activation of the aural. The text is amber in color and centered on the display.

The text will remain on the display until any one of the following conditions exists: configured timer expires (default is 16 seconds), range on the terrain display is changed, a new voice with associated visual annunciation is issued, a Terrain/Obstacle caution or warning condition exists, the enable logic goes false, or after a change in the altimeter setting is detected.

The visual annunciation may be enabled or disabled via the RCD.

6.2.2 Above Transition Altitude Monitor

The purpose of this Altimeter Monitor annunciation is to provide the flight crew with awareness if the altitude reference is not set to standard altitude after climbing above the transition altitude.

The annunciation generated from this monitor is classified as an advisory level as crew awareness may be required and immediate crew response is not necessarily imminent.

6.2.2.1 Annunciation Criteria

There are two implementation options for the Above Transition Altitude Monitor. The first option compares Corrected Barometric Altitude with Uncorrected Altitude and generates an annunciation if the difference is greater than the specified threshold after the aircraft has climbed above the transition altitude. This option is applicable to Boeing installations and other aircraft, except Airbus, where the corrected altitude output from the ADC (typically label 204) equals uncorrected altitude when the barometric reference is set to standard.

The second option is applicable to Airbus installations where the Corrected Altitude output from the ADC is not set to standard setting when the barometric reference is set to Standard. In these installations, the barometric reference setting is directly received by the EGPWS. An advisory will be generated if the barometric reference is not set to standard after passing through the transition altitude.

The Above Transition Altitude Monitor advisory is generated when the following conditions are met:

- Corrected Barometric Altitude, Uncorrected Barometric Altitude, and Runway Database are valid.
- The aircraft has been above the transition altitude for more than 30 seconds and not more than 5 minutes.
- The difference between Corrected Altitude and Uncorrected Altitude is less than the fixed threshold or the Barometric Altitude Reference does not equal standard, depending on the selected aircraft type.

6.2.2.2 Message Content

The aural message consists of the phrase “*Altimeter Setting*”. This aural message is issued once when the altimeter error is first detected and will repeat once, 8 seconds later. After two messages, no additional message will be generated.

The monitor will be re-armed if the enable logic goes false and then true or after a change in the altimeter setting is detected by the EGPWS.

6.2.2.3 Audio Level

By default, the aural message is generated at the EGPWS Warning volume, but the audio level may be adjusted to a different level using the RCD.

6.2.2.4 Visuals

Since this annunciation is considered an advisory, a visual is optional. If configured to do so, the EGPWS presents the text string “ALTM SETTING” overlaid on top of the terrain image upon activation of the aural. The text is amber in color and centered on the display.

The text will remain on the display until any one of the following conditions exists: configured timer expires (default is 16 seconds), range on the terrain display is changed, a new voice with associated visual annunciation is issued, a

Product Description – SmartRunway®/SmartLanding®

Terrain/Obstacle caution or warning condition exists, the enable logic goes false, or after a change in the altimeter setting is detected.

The visual annunciation may be enabled or disabled via the RCD.

6.3 Assumptions, Limitations, and Constraints

- Honeywell’s Altimeter Monitor provides advisory annunciations. It is classified this way because awareness may be required and crew response is not necessarily imminent.
- Appropriate flight crew action is as follows:

Alert	Expected Crew Response	Alert Level
<i>Altimeter Setting</i> (above transition altitude)	Check altimeter setting, procedure altitude, ATC assistance as necessary.	Advisory
<i>Altimeter Setting</i> (below transition altitude)	Check altimeter setting, procedure altitude, ATC assistance as necessary and climb if inadequate terrain separation is suspected in IMC. Check static ports & heaters.	Advisory

- The Altimeter Monitor is designed to detect errors caused by an incorrectly set altimeter. Other errors such as plugged static port or single or cumulative errors in the air data or other systems may also result in an advisory.
- The Altimeter Monitor is not designed to detect differences between corrected altitude and the geometric altitude of the aircraft caused by temperature variations or other deviations from the ISA model. Standard procedures and limitations for operations in non-standard ISA conditions, including cold temperature, remain applicable.
- Information contained herein or provided by the Altimeter Monitor advisory does not supersede any operator Standard Operating Procedure (SOP).
- Runway selection logic and transition altitude data may have errors inherent in the source of such data. Such errors can delay or prevent an advisory or may cause unwanted advisories.
- Other EGPWS aural alerts and warnings may preempt or delay the Altimeter Monitor advisory. Altimeter Monitor advisories may be issued during ATC radio communications, flight crew / cockpit communications, or during other aural messages provided in the cockpit by other aircraft systems.

7. Takeoff Flap Configuration Monitor

Important note: To use the Takeoff Flap Configuration Monitor, the EGPWS installed on the aircraft must already be connected to a source of flap position. Refer to Appendix G for a list of EGPWS aircraft types that support such a connection. In addition, as also described in Appendix G, some aircraft types may require that the Reactive Windshear Feature of the EGPWS be activated.

The Takeoff Flap Configuration Monitor is intended to inform the flight crew of improper flap setting for takeoff. With the benefit of the EGPWS Runway Database, alignment to the runway is detected allowing the annunciation to be provided well before thrust levers are advanced for takeoff.

7.1 Takeoff Flap Configuration Monitor Availability and Options

7.1.1 Takeoff Flap Configuration Monitor Operational Availability

Takeoff Flaps is operationally available anytime the EGPWS is powered and the following conditions are met:

- For MKV and MKVII EGPWS: Software Version 230-230 or later with a serial number EGPWC unit that has been enabled to use the functions described in this document (this is referred to as the ‘Enable Key being Set’), or EGPWS Software Version 965-1690-054 or later with the Enable Key Set, or 965-1676-004 or later with the Enable Key Set. For MKV-A EGPWS: software version 01.01 or later and Enable Key Set, or software version 51.01 or later and Enable Key Set. Refer to section 9.1 for more information on the Enable Key.
- Terrain Database 454 or later. Note that a S/W mod may be required in order to use databases 456 and later – refer to section 4.1.1 for more information.
- The Takeoff Flaps options have been loaded via an RCD into an EGPWC.
- The current airport is a RAAS-validated airport in the Runway Database (loaded as part of the Terrain Database)
- Takeoff Flaps is functional (e.g. all external signals are available and not faulted, GPS position accuracy meets minimum Takeoff Flaps requirements, and there are no internal EGPWC faults).

Takeoff Flaps Operational Availability is integrated into the existing EGPWS fault monitoring and Self-Test functions. The GPWS INOP Lamp will also reflect the status of the Takeoff Flaps function. An Aircraft-Type option is available to inhibit the Takeoff Flap Configuration Monitor status from driving the GPWS INOP Lamp should this be required for a given design. Consistent with approved EGPWS Self-Test design, the loss of Takeoff Flaps functions will be indicated on-ground during a level 1 Self-Test. Refer to Appendix E for a list of Self-Test maintenance messages.

7.1.2 EGPWS Runway Database

Current EGPWS databases contain airport and runway information. However, to ensure optimal Takeoff Flap Configuration Monitor performance, the accuracy of this data is re-verified and validated before the function can use the data. EGPWS Terrain database 454 and later contains additional airport and runway information that the monitor uses to determine if it can perform its intended function. Note that if the runway has been validated for RAAS it is also valid for the Takeoff Flap Configuration Monitor.

7.1.3 Signals Required

7.1.3.1 GPS Signals Required, Accuracy and Availability

Takeoff Flaps requires a high level of GPS position accuracy to function. GPS receivers used to provide position information must have a position resolution of 50 feet or better to meet this requirement. In addition to the basic set of GPS position data, Takeoff Flaps requires GPS Fine Latitude (ARINC 429 Label 120) and GPS Fine Longitude (ARINC 429 Label 121). Most ARINC 743/743A GPS systems provide these signals. The internal GPS receivers used with the EGPWS provide the needed resolution.

The Takeoff Flap Configuration Monitor does not require WAAS or Differential GPS (DGPS). However, either or both could enhance position accuracy of standard GPS data. The function monitors GPS accuracy and will automatically become Not Available if the accuracy degrades below acceptable limits. Factors which could degrade GPS accuracy include intentional accuracy degradation (Selective Availability activated), signal multipath, ionospheric and tropospheric delays, satellite geometry and shading, and system errors such as clock inaccuracies, etc.

7.1.3.2 Flap Position

Flap position is required for this function, so the EGPWS installed on the aircraft must already be connected to a source of flap position. This data can come from a flap handle or actual flap position and must be scaled in degrees.

Product Description – SmartRunway®/SmartLanding®

The discrete that indicates Landing Flaps/Not Landing Flaps is not appropriate for this monitor. Refer to Appendix G for a list of EGPWS aircraft types that support a flap position input.

7.1.4 Takeoff Flap Configuration Monitor Options Summary

The option for a separate cockpit selection to inhibit the Takeoff Flap Configuration Monitor annunciations has not been added to the aircraft configuration or EGPWS logic. Instead, the existing RAAS inhibit cockpit selection can be used to inhibit both RAAS and Takeoff Flap Configuration Monitor annunciations.

Global Options are applicable for all Takeoff Flap Configuration Monitor features and will be the same for all aircraft types programmed in the RCD. For example, aural annunciations may be specified to be a Male or Female voice. If the Male voice is selected, all annunciations will use the Male voice. If one alert is set to Male, another cannot be set to Female.

Aircraft-Type Specific options can be selected differently between various aircraft types specified in the RCD. The following table indicates which options are global and which are aircraft specific.

DESCRIPTION	Global Option	A/C Type Specific Option	SELECTIONS	REF SECTION
Voice Gender	X		FEMALE, MALE	3.1
Takeoff Flap Handle Minimum Setting		X	0 to 50 degrees (see note 1)	7.2.1
Takeoff Flap Handle Maximum Setting		X	0 to 50 degrees (see note 1)	7.2.1
Enable Visual Messages on Terrain Display	X		NONE, ALL, NON-ROUTINE ONLY, CAUTIONS ONLY	9.3

Note 1: In addition to physical Flap Handle settings, indicate what range (if any) the Flap Position input to the EGPWS is at those settings. For example, if an ARINC 429 Flap Angle input is the source of Flap Position to the EGPWS, what value will it indicate for the corresponding Handle positions: For example, a handle setting of 5 may result in a flap angle range of 3 to 7 degrees.

7.2 On Runway – Takeoff Flap Configuration Monitor

The purpose of the Takeoff Flap Configuration Monitor is to provide the flight crew with awareness of improper flap setting when the aircraft is lined-up on a runway in advance of takeoff.

The annunciation generated from this monitor is classified as a caution since immediate crew awareness is required and subsequent crew action may be required.

7.2.1 Annunciation Criteria

The Takeoff Flap Configuration Monitor annunciation is generated when the following conditions are met:

- Flap handle not within the valid takeoff flap setting, and
- Aircraft enters a runway, and
- Aircraft heading is within ± 20 degrees of the runway heading.

7.2.2 Message Content

The aural message consists of the phrase “*Flaps Flaps*” (refer to Figure 7-1). This aural message is annunciated once each time the aircraft enters, and is aligned with, a runway, if the flap setting is incorrect. No further aural messages are provided unless the flap handle is adjusted and, after 5 seconds of settling time, the flaps are still not set within

Product Description – SmartRunway®/SmartLanding®

the valid takeoff flap setting range. Should the pilot adjust the flaps after the first aural message but fail to set takeoff flaps, an additional “*Flaps Flaps*” message is provided. Each time a new flap setting is made, the aural will be provided if not within the takeoff flap range.

If the RAAS On Runway advisory is enabled, “*Flaps Flaps*” is appended to the end of the On Runway aural message. For example, “*On Runway Two-Four, Flaps Flaps*”, (refer to Figure 7-2). This aural message is announced once each time the aircraft enters a runway unless a new flap setting is selected as explained above. In this case the “*Flaps Flaps*” message may be announced without a RAAS advisory.

“Flaps Flaps”

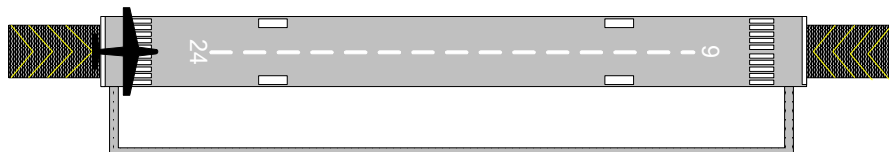

Figure 7-1: Takeoff Flap Aural – Without RAAS On Runway Enabled

“On Runway Two Four, Flaps Flaps”

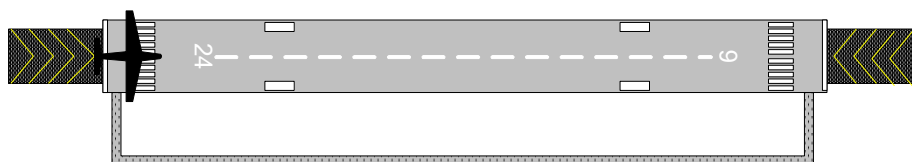

Figure 7-2: Takeoff Flap Aural – With RAAS On Runway Enabled

7.2.3 Audio Level

By default, the aural message is generated at the EGPWS Warning volume, but the audio level may be adjusted to a different level using the RCD.

7.2.4 Visuals

This annunciation is considered a caution, so a visual indication is required when an aural annunciation is activated. The function is configured, by default, to provide illumination of an existing EGPWS cockpit lamp and present the text string “FLAPS” overlaid on top of the terrain image upon activation of the aural. Configuration options allow the function to drive either the lamp or visual annunciation on the Terrain Display, both, or neither. If the cockpit lamp option is selected the caution lamp is illuminated upon activation of the annunciation and stays active as long as the incorrect flap setting condition exists.

Figure 7-3 shows a typical lamp interface. If the terrain display option is selected, the text is amber in color and centered on the display. The overlay “FLAPS” text will activate when the aural message is announced and remain active on the terrain display until the flap setting is corrected (default behavior) or, if configured, for a maximum of 16 seconds. The visual annunciation may be enabled or disabled via the RCD.

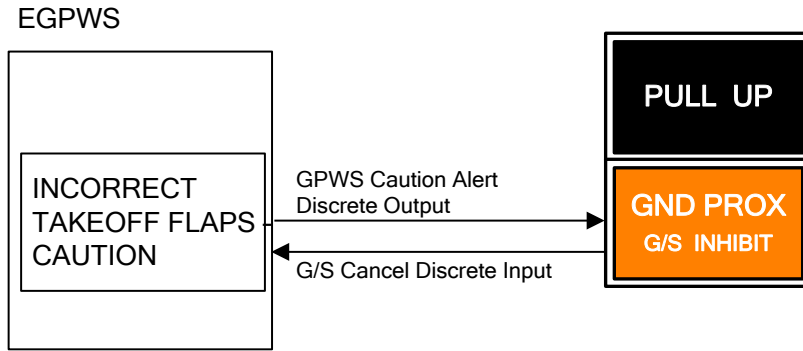

Figure 7-3: Incorrect Takeoff Lamp Visual

7.3 Assumptions, Limitations and Constraints

- Honeywell’s Takeoff Flap Configuration Monitor provides a caution alert. It is classified this way because immediate crew awareness is required.
- Appropriate flight crew action is as follows:

Alert	Expected Crew Response	Alert Level
<i>Flaps – Flaps on runway</i>	VERIFY Flap Setting and Configure as Necessary for Takeoff.	Caution

- Information contained herein or provided by a Takeoff Flap Configuration Monitor caution alert does not supersede any operator Standard Operating Procedure (SOP).
- Runway location data may have errors inherent in the source of such data. Such errors can delay an alert, or may cause unwanted alerts.
- The Takeoff Flap Configuration Monitor may become Not Available at any time due to loss of accuracy of GPS signals.
- Other EGPWS aural alerts may preempt Takeoff Flap alert. Takeoff Flap alerts may be issued during ATC radio communications, flight crew / cockpit communications, or during other aural messages provided in the cockpit by other aircraft systems.

8. Long Landing Monitor

The Long Landing Monitor function offers pilot increased runway awareness and complements the RAAS Distance Remaining callouts. The function advises the crew of their position during a landing when the aircraft has not touched down in a nominal amount of distance.

In addition to providing the Long Landing aural during a long landing event, a set of airborne only distance remaining callouts can also be selected.

The annunciations generated from this monitor are classified as caution level as immediate crew awareness and subsequent crew response is possibly required.

8.1 Long Landing Monitor Availability and Options

The operational availability criteria and operational status for RAAS In-Air callouts, as described in section 4.1.1, are applicable to the Long Landing Monitor.

The option for a separate cockpit selection to inhibit the Long Landing Monitor annunciations has not been added to the aircraft configuration or EGPWS logic. Instead, the existing RAAS inhibit cockpit selection can be used to inhibit both RAAS and Long Landing Monitor annunciations.

Global Options are applicable for all Long Landing Monitor features and will be the same for all aircraft types programmed in the RCD. For example, aural annunciations may be specified to be a Male or Female voice. If the Male voice is selected, all annunciations will use the Male voice. If one alert is set to Male, another cannot be set to Female.

Aircraft-Type Specific options can be selected differently between various aircraft types specified in the RCD. The following table indicates which options are global and which are aircraft specific.

DESCRIPTION	Global Option	A/C Type Specific Option	SELECTIONS	REF SECTION
Long Landing Monitor	X		OFF, ON	8.2
Voice Gender	X		MALE, FEMALE	3.1
Enable/Inhibit Discrete	X		NONE, INHIBIT, ENABLE	See above
Long Landing Voice	X		LONG LANDING, DEEP LANDING	8.2.2
Long Landing Reference Point	X		CALLOUT TRIGGER POINT MEASURED FROM APPROACH END OF RUNWAY CALLOUT TRIGGER POINT MEASURED FROM DEPARTURE END OF THE RUNWAY	8.2.2
Long Landing Distance		X	1 TO 10,000 FT (3000 METERS)	8.2.2
Long Landing Percentage		X	PERCENTAGE OF RUNWAY REMAINING TO TRIGGER CALL	8.2.2
Long Landing Distance Remaining	X		ON, OFF, INCLUDE UNITS	8.2.2

Product Description – SmartRunway®/SmartLanding®

DESCRIPTION	Global Option	A/C Type Specific Option	SELECTIONS	REF SECTION
Long Landing Distance Remaining Calls Datum	X		APPROACH END DEPARTURE END	8.2.2
Long Landing Distance Remaining		X	1 TO 10,000 FT (3000 METERS)	8.2.2
Long Landing Distance Remaining Percentage		X	PERCENTAGE OF RUNWAY REMAINING TO TRIGGER CALLOUTS	8.2.2
Enable Visual Messages on Terrain Display	X		NONE, ALL, NON-ROUTINE ONLY, CAUTIONS ONLY	9.3

8.2 Long Landing Monitor

The Long Landing Monitor adds two new distance remaining annunciations to enhance crew awareness of aircraft along-track position relative to the runway end. One provides annunciations if the aircraft has not touched down before a configurable threshold and the second provides airborne only aural annunciations of current distance from aircraft to the runway end.

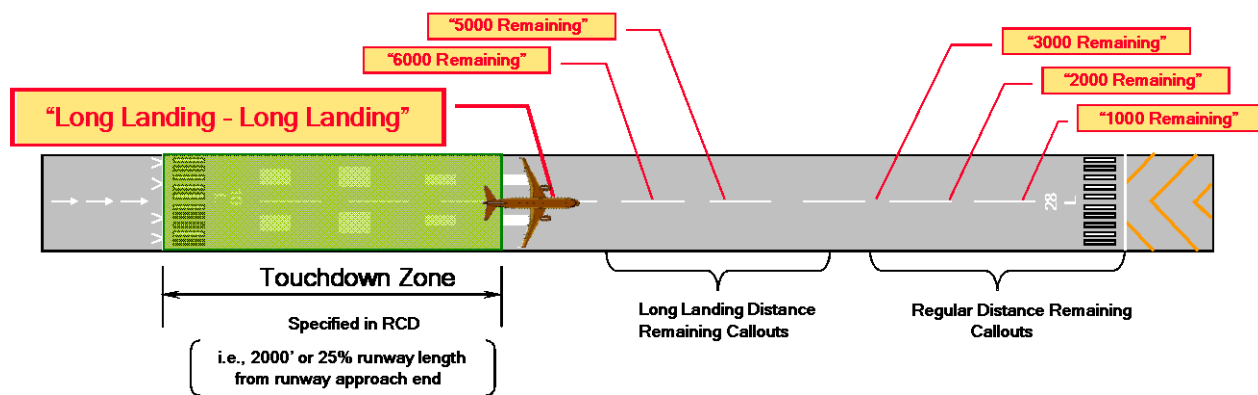

Figure 10-1: Long Landing Aural with Subsequent Distance Remaining Calls

The Long Landing Monitor uses GPS position data and the Honeywell EGPWS Runway Database to provide aural and visual annunciations that supplement flight crew awareness of aircraft position in relation to the runway.

8.2.1 Annunciation Criteria

The Long Landing and airborne only Distance Remaining alerts are generated when the following conditions are met:

- Aircraft is within 100 feet AGL, past a customer specified distance from the runway end (see below);
- Aircraft is airborne above 5 feet AGL, or weight on wheels is false

The callout triggers are defined by several RCD items:

- 1) Base callout activation relative to approach or departure end of runway
- 2) Percentage of runway remaining to trigger callouts (used for shorter runways – see section 8.2.2 for an example)
- 3) Fixed distance from threshold end (or departure) to trigger the calls (used for longer runways – see section 8.2.2 for an example)

Using these RCD selections, a flexible enabling threshold method is provided to allow the calls to be based on a fixed distance from departure end or a fixed distance from approach end, and a percentage of runway length. To allow for short runways and long runways, the two computed thresholds are evaluated and the threshold that provides the longer distance from the departure end of the runway is used for the trigger point.

Long Landing callouts are disarmed once the on-ground condition is met (radio altitude or weight on wheels depending on aircraft configuration). This prevents a second Long Landing callout in the case of a touch-and-go landing.

Long Landing distance remaining callouts are not disarmed by the on-ground condition, and if the aircraft becomes airborne (bounced landing or erroneous radio altitude) after the Long Landing trigger distance, then Long Landing distance remaining callouts may occur even if no Long Landing callout preceded it.

Long Landing distance remaining callouts are designed such that the callout completes approximately when the aircraft is abeam the annunciated distance. In cases of high speed landings, some Long Landing distance remaining callouts may be skipped if they cannot be voiced in a timely manner following the completion of the previous Long Landing callout or Long Landing distance remaining callout.

8.2.2 Message Content

If the aircraft has not touched down before a configurable threshold, the EGPWS will issue the default aural “*Long Landing – Long Landing*”. The message can be configured to “*Deep Landing – Deep Landing*”. In addition, airborne only aural annunciations of current distance from aircraft to the runway end can be enabled.

If still airborne, the Long Landing distance remaining callouts are given the same syntax as the on ground distance remaining callouts. For systems using feet as the unit of length, these advisories are generated at whole thousand-foot intervals.

As an example:

- 1) 75% is chosen for the ‘percentage’ item for both Long Landing and Long Landing Distance Remaining calls.
- 2) 2,000 feet is chosen for the ‘fixed distance’ item for both Long Landing and Long Landing Distance Remaining.
- 3) Approach end is chosen for the ‘reference point’ item for both Long Landing and Long Landing Distance Remaining calls,

In this case, if the aircraft is landing on a 10,000 foot runway, and remains airborne with 8,000 feet remaining (2,000 feet beyond approach end), then the Long Landing call would occur, followed by “7000 Remaining”, and so on (if still airborne).

Product Description – SmartRunway®/SmartLanding®

Alternately, if the same aircraft was landing on a 6,000 foot runway, and remained airborne with only 4,500 feet remaining (the 75% point), then the Long Landing call would occur, followed by “4000 Remaining”, and so on (if still airborne).

If the RCD option to annunciate the unit of measurement is enabled, “Feet” or “Meters” will be included in the first phrase. For example, “Four-Thousand Feet Remaining” followed by “Three-Thousand Remaining” and so on.

8.2.3 Audio Level

By default the aural message is generated at the volume selected for the Distance Remaining callouts. This can be adjusted to a different level using the RCD.

8.2.4 Visuals

This annunciation is considered a caution, so a visual indication is required when an aural annunciation is activated. The function is configured, by default, to provide illumination of an existing EGPWS cockpit lamp and present the text string “LONG LANDING” or “DEEP LANDING” overlaid on top of the terrain image upon activation of the aural. Configuration options allow the function to drive either the lamp or visual annunciation on the Terrain Display, both, or neither. If the cockpit lamp option is selected the caution lamp is illuminated upon activation of the annunciation and stays active as long as the condition exists.

Figure 10-2 shows a typical lamp interface. If the terrain display option is selected, the text is amber in color and centered on the display. The overlay “LONG LANDING” or “DEEP LANDING” text will activate when the aural message is annunciated and remain active on the terrain display until the annunciation criteria is no longer met, Radio Altitude is less than or equal to 5 feet or greater than or equal to 100 feet, In Air is false, or, if configured, for a maximum of 16 seconds.

The visual annunciation may be enabled or disabled via the RCD.

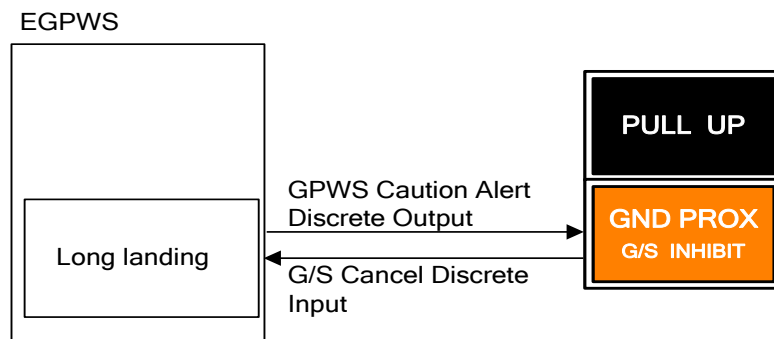

Figure 10-2: Lamp Visual (Activated for Long Landing Annunciation)

8.3 Assumptions, Limitations and Constraints

- Honeywell’s Long Landing Monitor provides a caution alert. It is classified this way because immediate crew awareness is required.
- Appropriate flight crew action is as follows:

Alert	Expected Crew Response	Alert Level
<i>Long Landing – Long Landing</i>	Confirm aircraft position and initiate go-around if appropriate.	Caution
Long landing distance remaining calls	--	Advisory - Provides awareness of runway distance remaining before touchdown

- All assumptions, limitations, and constraints applicable to RAAS In-Air callouts as described in section 4.4 are applicable to the Long Landing Monitor.

9. Configuration, Enable Key, and Program Pin

The functions described in this document are activated by a three-step process (refer to Figure 9-1 below).

- (1) Ensure a minimum of software versions 230-230, 965-1690-054, or 965-1676-004 for MKV/MKVII EGPWS, or software versions 01.01 or 51.01 for MKV-A EGPWS, a minimum Terrain Database of 454 is loaded, and GPS with fine latitude and longitude labels per ARINC 743/743A are interfaced directly into EGPWS. If enabling the Takeoff Flap Configuration Monitor insure Flap Position input supported and connected. If enabling the Excessive Speed alert function of the Approach Monitor (“Too Fast”), insure Reference or Approach Speed supported and connected.

Note that a S/W mod may be required in order to use databases 456 and later – refer to section 4.1.1 for more information.

Note that for MKV or MKVII EGPWS, a minimum of 232-232, 965-1690-055, or 965-1676-005 software may be required for the Excessive Speed Monitor. See Appendix G for more information.

For MKV-A or MKV/MKVII 236-236, 965-1690-057, or 965-1676-006 software versions and later, if enabling the QFE Override option, ensure that the aircraft is certified to support non-QFE landings at QFE destinations.

- (2) The Enable Key is set within the EGPWS (see section 9.1).
- (3) Load the RCD (or OSS, for certain MKV-A configurations).
- (4) Program Pin: The functions described here can be also configured to only be active if both an RCD is loaded and an EGPWS program pin is selected. Refer to section 9.4 for more details.

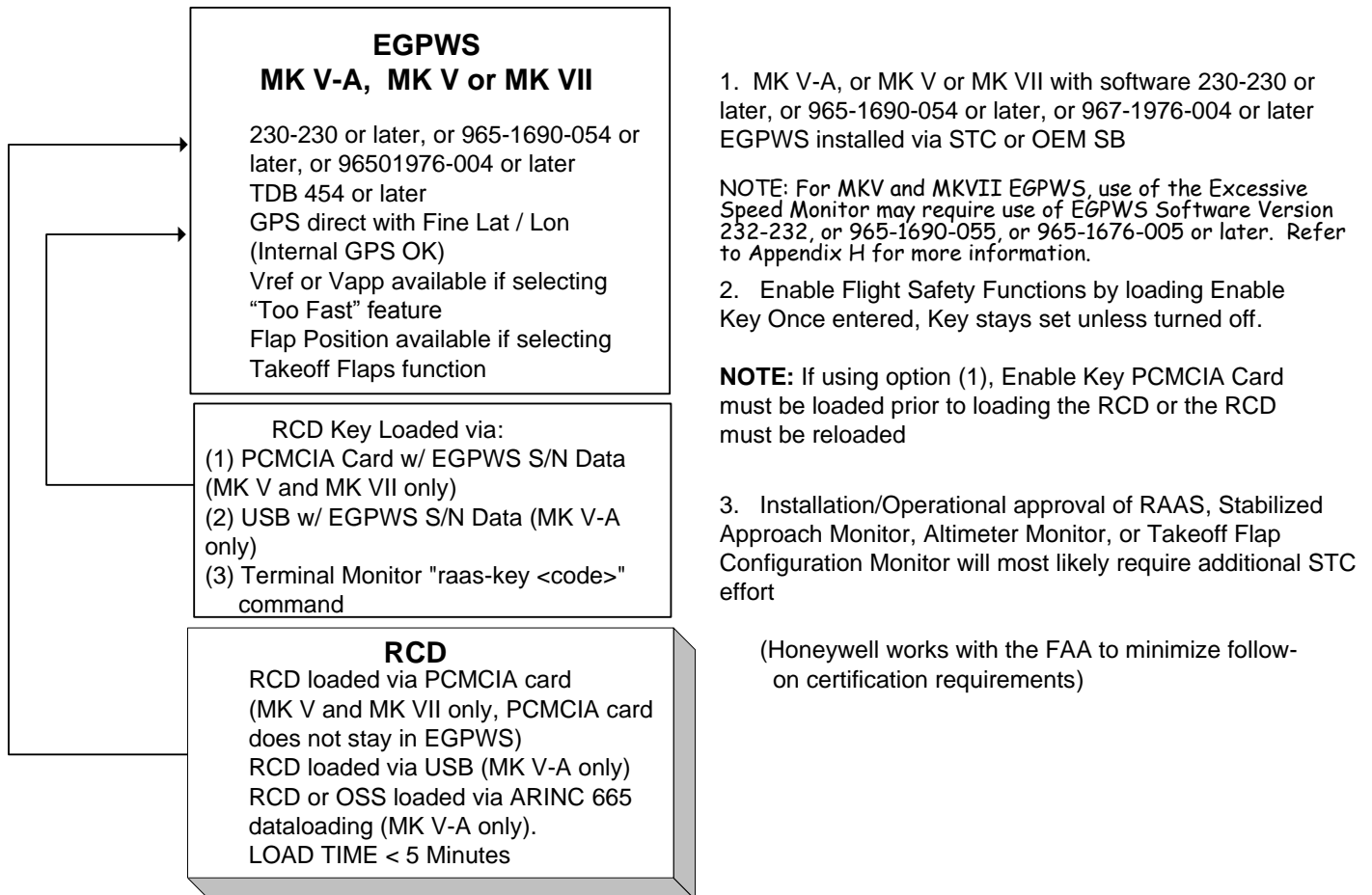

Figure 9-1: Function Activation

9.1 Enable Key

In order for the EGPWS to recognize the RCD, an enabling “Key” must be set. This key is based on EGPWS part number and serial number and once set, stays active within the EGPWS. The RCD Enable Key is set by one of two methods:

- (1) Enable key on PCMCIA Card (MKV or MKVII EGPWS) or USB mass storage device (MKV-A EGPWS).
- (2) Enable Key Code set via the EGPWS RS-232 Terminal Monitor interface. This key code is an eight alphanumeric character string.

The Level 3 Self-Test message “*RUNWAY AWARENESS ENABLE SET*” is annunciated to confirm that the Enable Key is set.

The enable key PCMCIA card, USB file, or key code is provided by Honeywell when the customer orders any of the safety functions described in this document and provides EGPWS part number and serial number information. Note that the enable key can be cleared for troubleshooting or if the unit is repaired.

9.2 Reloadable Customer Definitions (RCD)

The final step to enabling the Flight Safety Functions described herein is to load an option-specific customer definitions file which functions much like a set of hardware program pins. This file is referred to as Reloadable Customer Definitions (RCD). Certain MKV-A configurations may use an Option Selection Software (OSS) file to configuration SmartRunway/SmartLanding in place of the RCD; the following description is applicable to both the RCD and the OSS.

Configuration options when downloaded become part of a specific Line Replaceable Unit (LRU). The RCD allows for the setting of common fleet options as well as GPS antenna position and defining the nominal runway lengths for multiple aircraft types. Each RCD can support up to 20 different aircraft types. Thus an operator with a mixed fleet of aircraft can swap EGPWS LRUs within the fleet and will not be required to reload RCDs to keep the nominal runway lengths correct across the fleet. The RCD can also be used to support customers operating both MK V and MK VII EGPWS on mixed fleets.

The RCD is divided into 2 parts:

- (1) Global Options. Global Options are applicable across the board for each individual function, and will be the same for all aircraft types programmed in the RCD. Refer to the options summary section for each function.
- (2) Aircraft-Type Options define aircraft-specific parameters such as nominal runway lengths for take-off and landing advisories and GPS antenna location. Refer to the options summary section for each function.

Whenever any of the flight safety features are ordered, a worksheet will be provided, or one can be accessed via the EGPWS website (www.egpws.com), completed, and sent electronically to Honeywell for RCD creation.

Each RCD is composed of a set of configuration options. Each RCD is assigned a unique part number. In cases where customers select the same option set on the same EGPWS and aircraft type, they will receive the same RCD (same RCD Part Number).

The installed RCD part number can be verified by several methods:

- (1) An abbreviated RCD part number is displayed on the terrain display during level 1 Self-Test. The last 5-digits of the software part number are displayed.
- (2) The complete 10-digit RCD software part number is annunciated during level 3 Self-Test or can be displayed using the EGPWS RS-232 Terminal Monitor “Present Status” command.

9.3 Incorporation of the Pilot's Point of View

There are number of functions that use GPS Antenna location on the aircraft. These are Approaching Runway – On Ground, Distance Remaining Land and Roll-Out, Distance Remaining Rejected Take-Off, Runway End, and Deep Landing. In addition to the actual distance from the nose of the aircraft to the GPS antenna, the Pilot's Point of View (PpoV) offset should also be taken into account. The Pilot's Point of View is the distance in front of the aircraft which is not normally visible to the flight crew when sitting in the cockpit. Adding this distance to the antenna distance results in the callouts occurring earlier and helps ensure that related reference points on the ground are visible to the flight crew when a corresponding RAAS callout is generated. This is accomplished by the following calculation:

GPS Antenna Location on aircraft = Pilot's Point of View (PpoV) offset + the Distance from aircraft nose to the GPS Antenna as specified in the RCD worksheets

This computation is done as part of the RCD generation. It provides the ability for these specific annunciations to be given relative to where the pilot is looking and is specifically related to an aircraft's geometry.

The Pilot's Point of View is depicted below:

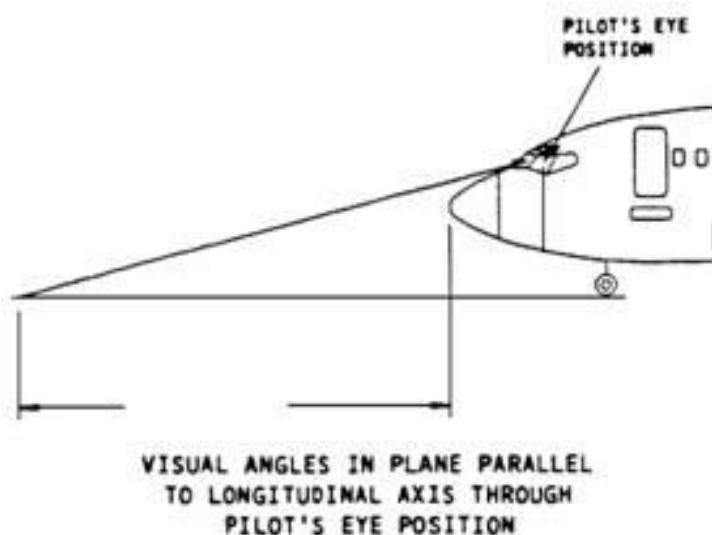

Tables 9-1 and 9-2 list the aircraft specific PPOV offset from the nose of the aircraft to the point on ground that the pilot can see.

Product Description – SmartRunway®/SmartLanding®

Table 9-1: MK V Pilot’s Point of View Offset

Aircraft Type in the MK V	Aircraft Type Number(s)^{1,5}	PPoV Offset (feet)²
A300-600R / A310	108, 172, 230	45
A319 / A320 / A321	001, 113, 132 148, 229	45
A330 / 340	057, 133, 136 228	45
B707	213	N/A
B737-100 /200 /300/400/500/600/700/800	004, 008, 009, 010, 016, 017, 018 101, 143, 144 145, 174, 175 187, 192, 193 194, 195, 196 197, 207, 214 215, 216, 217 218, 219, 220 225, 226, 227	40
B737-NG	212	40
B747-400	002, 030, 100 111, 188, 198	70
B747-8	189, 191	70
B757-200 / 300	006, 105, 116 146, 169 199 200, 224	35
B767-200 / 300 / 400	003, 005, 031 106, 109, 147 170, 171, 173 201 202, 203 204 209, 210 211, 221, 222 223	40
B777-200 / 300	205, 206, 208	45
DC8	130	25
DC9	139	25
MD-10 / 11	044, 045	50
MD-80 / 90 / 95	114, 115, 118 119, 120, 129 179, 180	30
Avro RJ	054, 055	25
Beech 300 & FIAS Beech 300	060, 074	25
BeechJet 400A	162, 163	20
Canadair CL300	026, 034	30
Canadair CL601	081, 085, 161 165	30
Canadair CL604	039, 040	25
Canadair CL604DX/605	056	25
Canadair CRJ-700/900	046	25
Canadair GEX	097	30
Canadair RJ-100 / 200	043, 047	25
CASA	155	N/A
Cessna Citation Jet 1 / 2 / 3	032, 037, 038	30
Cessna Citation X	062	30
Cessna CJ4	168	30
Cessna Excel	103, 167	30
Cessna XLS Plus	159	30
Cessna Encore Plus	160	30
Dassault Falcon 20F	070, 071, 077	30
Dassault Falcon 2000/2000EX	091, 125	30
Dassault Falcon 50 / 50EX	082, 092, 094 126	30
Dassault Falcon 900 / 900B / 900C/ 900EX	075, 093, 157	30
Dehavilland Dash 8-400	088, 152	N/A
Dornier 328	035, 041	N/A
Embraer-145/135, Legacy 600/650	033	25

Product Description – SmartRunway®/SmartLanding®

Aircraft Type in the MK V	Aircraft Type Number(s)^{1,5}	PPoV Offset (feet)²
FIAS CL601/3R & Learjet 60	076, 142	30
FIAS Learjet 60 w/ reactive Windshear	080	20
Fokker 100	131	N/A
Gulfstream G-II / IIB / III / IV / V	068, 069, 079 087, 096, 104	35
Gulfstream G-200	089, 154	25
Gulfstream G-100 / 150	090, 156, 177	20
Hawker 800C/800S/800SF	065, 066, 073, 138	15
Hawker 800XP	176	15
Hawker 1000	067	20
Hawker Horizon/4000	110	20
Honeywell: Beechcraft King Air C-90	064, 098, 128	25
Honeywell: Sabre 65	117	25
Lear 45	102, 166	30
Lear 60	078	20
Premier 1	112	N/A
RC-135	134	N/A
SAAB 2000	036	N/A
Tupelov TU-204 / 214	158	45
Antonov AN-148-100	158	30
Test Aircraft Types	000, 063, 095 099	N/A
Lockheed C-130	123, 150	N/A
Lockheed C-5	137	N/A
MKVIII Emulation	0	N/A
NIMROD MRA4	122	N/A
VC-135 Speckled Trout	153	N/A
KC-135	135	N/A

Table 9-2: MK VII Pilot’s Point of View Offset

Aircraft Type in the MK VII	Aircraft Type Number(s)^{1,5}	PPoV Offset (feet)²
A300-B2/B4	058	45
B727-100 / 200	005 ^{3,4} , 006, 019, 020 041, 054	40
B737-200	040	40
B747-100 / 200 / 300	016, 042, 052	70
B747-SP	059	70
DC8	043, 053, 062	25
DC9	013, 060, 061	25
DC10-10/30/40	011, 014, 023 027	50
ASTRA SP	050	35
Canadair CL600	044	30
Canadair CL601	045	30
Cessna Citation II/550	068	30
Cessna Citation V/Ultra	028, 029	30
Cessna Citation III / VI / VII	030	30
Cessna Citation Bravo	031	30
Cessna Citation Encore	066	30
Convair	003 ^{3,4}	45
Dassault Falcon 10 / 100	055, 004 ⁴	30
Dassault Falcon 20F	034, 035 , 004 ⁴	30
Dassault Falcon 200	067, 004 ⁴	30
Dassault Falcon 50 / 50EX	036, 004 ⁴	30
Gulfstream G-II / IIB / III	038, 039	35
Hawker 700	008 ³ , 009 ³ , 010 ³	N/A
Hawker 800	008 ³ , 009 ³ , 010 ³	15
Honeywell: Beechcraft King Air C-90	056, 063	25
Jetstar II	069	N/A
Lear 31A	037	20
Lear 35 / 55	032, 033, 047	N/A
Lockheed L1011	005 ^{3,4} , 057	45
Westwind II	051	N/A
Test Aircraft Types	000, 001, 002 003 ^{3,4} , 004 ^{3,4} , 005 ^{3,4} , 007 ⁴	N/A
C-141	48	N/A
C-2A	65	N/A
Lockheed C-130	49	30
VP/UP-3	64	N/A

¹ The Aircraft Type Number references specific aircraft which the EGPWS MKV/VII currently support.

² N/A means that information is not yet available to determine the Pilot Point of View Offset for that specific aircraft type.

³ This aircraft type is listed more than once because there are different customers that use this aircraft type and, therefore, may require different Pilot Point of View Offset values.

⁴ Aircraft types 003, 004, 005, and 007 are a non-Windshear aircraft configurations that can be used by any compatible aircraft, meaning there can be a different Pilot Point of View Offset value among the various users of these aircraft types. The user of this table should reference a similar Windshear activated aircraft type to obtain the PPoV that can be used with the non-Windshear configuration.

Product Description – SmartRunway®/SmartLanding®

⁵ MKV-A installations have the option to set program pin options through loadable software files (either an APD - Aircraft Personality Database, or OSS - Option Selection Software) instead of the hardware program pins used on the MKV and MKVII EGPWS. If the MKV-A is configured in this manner, the aircraft type ID number will be the legacy (MKV, MKVII) aircraft type number plus 500. For example, the Boeing 737-NG is type number 212 on MKV, MKVII, or MKV-A when configured using only hardware program pins. On MKV-A configured using a loadable configuration definition file (APD or OSS), the Boeing 737-NG is type number 712.

9.4 RCD Program Pin

The functions described in this document are typically enabled via loading an RCD into the EGPWC. And, as has been discussed herein, some of the RCD based functions can be defined to have an enable discrete, or an inhibit discrete, but not both for MKV and MKVII EGPWS.

However, if it is desired to have an inhibit switch, and also only enable these functions on specific tail numbers, a method to require a program pin be selected is available with the MKV-A or MKV EGPWS (not the MKVII). Strapping details for this program pin are found in Appendix D-15 of the *Interface Control Document for the Mark V Enhanced Ground Proximity Warning System (MKV EGPWS)*, Honeywell Document, 993-0976-401, Revision AC or later, or in the *Interface Control Document for the MKV-A EGPWS* (Honeywell Document SYS69000940-700).

The MKV-A EGPWS can be configured to support both an inhibit and an enable discrete, but for consistency with the MKV, may also use the method described above.

Please note that the RCD has to be defined to use this program pin. This enabling option is not included on the RCD Worksheet and will be treated as a special request.

9.5 Visual Message Options

There are several options to overlay visual text messages for advisories and cautions on the Terrain Display, and several examples of this overlay are contained within this document - see Figure 5-1 for one example. Appendix B through F specifies the exact text used for all messages.

Via the RCD worksheet the customer can select from one of the following options:

- 1) No Text overlay messages
- 2) Display messages for all advisories and cautions described in this document.
- 3) Display messages just for all Non-Routine advisories (and cautions) described in this document.
- 4) Display messages just for the cautions described in this document.

Appendices

Appendix A: Definitions

<u>Acronym</u>	<u>Interpretation</u>
A/C	Aircraft
AFE	Above Field Elevation
AGL	Above Ground Level
APD	Aircraft Personality Database
ARINC	Aeronautical Radio Incorporated standard
ATC	Air Traffic Control
ATIS	Automatic Terminal Information Service
dB	Decibel
DGPS	Differential Global Positioning System
EFIS	Electronic Flight Instrument System
EGPWC	Enhanced Ground Proximity Warning Computer
EGPWS	Enhanced Ground Proximity Warning System
GPS	Global Positioning System
ICD	Interface Control Document
ILS	Instrument Landing System
LRU	Line Replaceable Unit
ND	Navigation Display
NOTAM	Notice To Airmen
OSS	Option Selection Software
PPoV	Pilot's Point of View
RAAS	Runway Awareness and Advisory System
RCD	Reloadable Customer Definitions
RTO	Rejected Take-Off
WAAS	Wide Area Augmentation System

Appendix B: Runway Awareness and Advisory System Visuals, Aural and Volume Levels

Table B-1 lists RAAS messages, both aural and visual. Typically RAAS aural are issued at one of three volume levels:

(1) By default the In-Air and On-Ground Advisories **except** Distance Remaining and Taxiway Takeoff Advisories are issued 6 dB below the volume level of the EGPWS Cautions and Warnings defined by the Program Pin strapping. However, these volume levels can be adjusted differently via the RCD.

(2) By default the RAAS Cautions and Distance Remaining Advisories are issued at the same volume level as EGPWS Cautions and Warnings defined by the Program Pin strapping. However, these volume levels can be adjusted differently via the RCD.

(3) By default the Taxiway Takeoff Caution/Advisory is issued at the EGPWS Cautions and Warnings volume level listed in item (2) above, plus 3dB. However, the volume level can be adjusted differently via the RCD.

RAAS Self-Test messages are integrated into the existing EGPWS Self-Test functions. RAAS Self-Test messages are issued at the same volume as existing EGPWS Self-Test messages (6dB lower than the EGPWS Cautions and Warnings defined by the Program Pin strapping).

For MK V-A EGPWS, or MK V/MK VII EGPWS with software version -236-236, -057, -006 and later an option is provided to coordinate the Self Test Level 1 audio with the status from a single RAAS Monitor discrete. If the customer elects to install a RAAS Monitor discrete which reflects the status of all the enabled SmartRunway® and SmartLanding® alert monitors this option should be selected.

Examples of behavior with option set:

- If Stabilized Approach Monitor only is enabled, the self-test level 1 will annunciate:
RUNWAY AWARENESS OK
- If Stabilized Approach Monitor and RAAS are enabled, the self-test level 1 will annunciate:
RUNWAY AWARENESS OK, [UNITS]
- If Stabilized Approach Monitor/RAAS is enabled and unavailable, the self-test level 1 will annunciate:
RUNWAY AWARENESS NOT AVAILABLE
- If Stabilized Approach Monitor/RAAS is enabled and is inoperative, the self-test level 1 will annunciate:
RUNWAY AWARENESS INOP

Table B-2 provides a listing of RAAS maintenance messages.

Table B-3 lists displayed RAAS status messages.

Figure B-1 describes the RAAS Caution Lamp.

Product Description – SmartRunway®/SmartLanding®

Table B-1: RAAS Alert Messages and Volume Levels

REF SEC	ADVISORY/ CAUTION	AURAL MESSAGE Male or Female	VISUAL MESSAGE and color (Optional)	NOTES:	DEFAULT VOLUME LEVEL As defined above
4.1	Approaching Runway - In Air	<i>"Approaching XX"</i>	APP XX (in green)	XX – Runway Identifier including Left, Right, Center (from Runway Database)	(1)
4.2	Approaching Runway – On Ground	<i>"Approaching Runways"</i>	APP RWYS (in green)	Message if more than one runway meets the qualifying condition.	(1)
4.3	On Runway – On Ground	<i>"On Runway XX"</i> <i>"On Runway Runways"</i>	ON XX (in green) ON RWYS (in green)	XX – Runway Identifier (from Runway Database) Message if more than one runway meets the qualifying condition.	(1)
4.4	Distance Remaining – Landing	<i>"ZZ Remaining"</i>	NONE	ZZ = Calculated distance in FEET (annunciated in whole 1000 feet intervals) - OR - METERS (annunciated in whole 300 meter intervals)	(2)
4.5	Runway End Callout	<i>"One Hundred Remaining"</i> <i>"Thirty Remaining"</i>	NONE	Callout in FEET Callout in METERS	(2)
5.1.1	Approaching Short Runway Advisory – In Air (Landing)	<i>"Approaching Runway XX,, ZZ Available"</i>	APP XX ZZ (in amber)	XX – Runway Identifier (from Runway Database) ZZ = Available runway distance in FEET (to nearest whole 100 feet from Runway database) or Meters (to nearest whole 100 meters)	(1)

Product Description – SmartRunway®/SmartLanding®

5.1.2	Approaching Short Runway Caution– In Air (Landing)	<i>“Caution, Short Runway Short Runway”</i>	SHORT RUNWAY (in amber)		(2)
5.2.1	Insufficient Runway Length – On Ground (Takeoff)	<i>“On Runway XX, ZZ Remaining”</i>	ON XX ZZ (in amber)	XX – Runway Identifier (from Runway Database) ZZ = Available runway distance in FEET (to nearest whole 100 feet from Runway database) or Meters (to nearest whole 100 meters)	(1)
5.2.2	Insufficient Runway Length Caution – On Ground (Takeoff)	<i>“Caution, Short Runway Short Runway”</i>	SHORT RUNWAY (in amber)		(2)
5.3	Extended Holding - On Runway	<i>“On Runway XX – On Runway XX ”</i>	ON XX (in amber)	XX – Runway Identifier (from Runway Database)	(1)
5.4.1	Taxiway Takeoff Advisory	<i>“On Taxiway! On Taxiway!”</i>	ON TAXIWAY (in amber)		(3)
5.4.2	Taxiway Takeoff Caution	<i>“Caution, On Taxiway! On Taxiway!”</i>	ON TAXIWAY (in amber)		(3)
5.5	Distance Remaining – Rejected Takeoff	<i>“ZZ Remaining”</i>	NONE	ZZ = Calculated distance in FEET (annunciated in whole 1000 feet intervals) - OR - METERS (annunciated in whole 300 meter intervals)	(2)
5.6	Taxiway Landing Caution	<i>“Caution, Taxiway!, Caution Taxiway!”</i>	TAXIWAY (in amber)		(2)

Table B-2: RAAS Maintenance Messages

MAINT. FUNCTION	MESSAGE Except where noted, all maintenance message voices are Male	NOTES: All volume levels at same volume as existing EGPWS Self-Test messages
Self-Test Level 1 (Annunciated after Terrain Awareness part of Self-Test)	<p><i>“Runway Awareness OK - Feet”</i></p> <p><i>“Runway Awareness OK - Meters”</i> Note: Feet and Meters will be annunciated in the gender voice option (Male or Female) selected for RAAS.</p>	<p>RAAS enabled, functioning, has good position information, and is at a validated airport. Distances annunciated in Feet.</p> <p>RAAS enabled, functioning, has good position information, and is at a validated airport. Distances annunciated in Meters.</p>
Self-Test Level 1	<i>“Runway Awareness Not Available”</i>	RAAS enabled, but the system either has no position information, the accuracy of the position information is insufficient to allow RAAS to function, or the aircraft is at airport that has not been validated in the EGPWS Terrain Database
Self-Test Level 1	<i>“Runway Awareness Inhibited”</i>	<p>RAAS enabled, but the advisories have been inhibited with the activation of an external discrete.</p> <p>Optional via RCD: RAAS or Stabilized Approach Monitor or Altimeter Monitor inhibited</p>
Self-Test Level 1	<i>“Runway Awareness INOP”</i>	RAAS enabled but the function is inoperative
Self-Test Level 1	<i>“Runway Awareness R-T-O”</i>	RAAS enabled and functioning, but RAAS advisories (other than distance remaining) are temporarily inhibited because RAAS has detected a Rejected Take-Off condition. To clear this message and enable RAAS advisories, the aircraft must be taxied off the runway area.
Self-Test Level 3 (Annunciated at end of Selected Options)	<i>“Runway Awareness Enable Set”</i>	RCD Enable Key is set. The RCD is not loaded.
Self-Test Level 3 (Annunciated at end of Selected Options)	<i>“Runway Awareness Enabled”</i>	RCD is loaded and RCD Enable Key is set. Note: This message replaces the <i>“Runway Awareness Enable Set”</i> message.
Self-Test Level 3	<i>“RCD Part Number XXX-XXXX-XXX”</i> where X is the 10-digit installation-specific RCD part number.	Allows verification that the correct RCD is loaded into the EGPWS.
Self-Test Level 4	<i>“Runway Awareness Inhibit Invalid”</i>	In some installations the RAAS Inhibit switch is configured to cause a fault if left selected in cruise. This is the fault message if that occurred.

Table B-3: RAAS Displayed Maintenance Messages

MAINT. FUNCTION	DISPLAYED MESSAGE	NOTES:
Self-Test Level 1 (Displayed as part of the EGPWS Self-Test Pattern)	RCDxyz12 (magenta)* * May be green depending on display	Displayed immediately above or below the TDB Version display. RCD version “xyz12” is the last 5 digits of the 10-digit RCD part number (labeled on PCMCIA card or USB media).
On-Ground status	RAAS-OK-FT (green) RAAS-OK-M (green)	RAAS enabled, functioning, has good position information, and is at a validated airport. Distances annunciated in Feet. RAAS enabled, functioning, has good position information, and is at a validated airport. Distances annunciated in Meters.
	RAAS-N/AVBL (amber)	RAAS enabled, but the system either has no position information or the accuracy of the position information is insufficient to allow RAAS to function
	RAAS-NA-X (amber)	RAAS enabled, but the destination airport has not been validated for RAAS in the EGPWS Terrain Database. X = the destination airport designator.
	RAAS-RTO (green)	RAAS enabled but advisories are inhibited because a RAAS Rejected Take-Off was detected
	RAAS-INOP (amber)	RAAS enabled but function is Inoperative

Some RAAS annunciations are considered cautions. If these are selected, then a visual indication is required when an aural annunciation is activated. The function is configured, by default, to provide illumination of an existing EGPWS cockpit lamp.

The lamp is illuminated upon activation of the annunciation and stays active as long as the condition exists. Figure B-1 shows an example of a typical lamp interface.

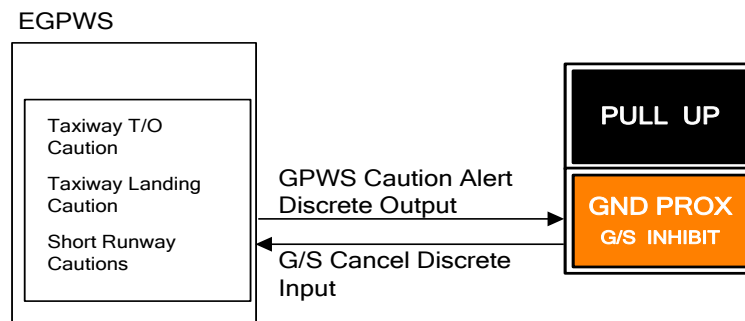

Figure B-1: Lamp Visual (Activated for RAAS Caution Annunciations)

Appendix C: Stabilized Approach Monitor Visuals, Aural and Volume Levels

Table C-1 lists Stabilized Approach Monitor aural and visual messages.

- (1) Stabilized Approach Monitor advisories are issued at the EGPWS Cautions and Warnings volume level (defined by the Program Pin strapping). However, the volume level can be adjusted differently via the RCD.
- (2) Stabilized Approach Monitor Self-Test messages are integrated into the existing EGPWS Self-Test functions and are issued at the same volume as existing EGPWS Self-Test messages (6dB lower than the EGPWS Cautions and Warnings defined by the Program Pin strapping).

Table C-2 provides a listing of Stabilized Approach Monitor maintenance messages.

Table C-1: Stabilized Approach Monitor Messages and Volume Levels

REF SEC	MONITOR	AURAL MESSAGE Male or Female	VISUAL MESSAGE	NOTES:	VOLUME LEVEL (see above)
6.1	Flap Monitor Alert – Upper Gate	<i>“Flaps (pause) Flaps”</i>	FLAPS (in amber)	Advisory	(1)
	Flap Monitor Alert – Lower Gate	<i>“Flap-Flaps”</i>	FLAPS (in amber)	Advisory	(1)
6.2	Excessive Approach Angle Monitor	<i>“Too High-Too High”</i>	TOO HIGH (in amber)	Advisory	(1)
6.3	Excessive Approach Speed Monitor	<i>“Too Fast-Too Fast”</i>	TOO FAST (in amber)	Advisory	(1)
6.4	Unstable Approach Monitor	<i>“Unstable-Unstable”</i>	UNSTABLE (in amber)	Caution	(1)

Table C-2: Stabilized Approach Monitor Maintenance Messages

MAINT. FUNCTION	MESSAGE	NOTES:
	Except where noted, all maintenance message voices are Male	All volume levels at same volume as existing EGPWS Self-Test messages
Self-Test Level 1	<i>“Approach Monitor Inhibited”</i>	Stabilized Approach Monitor enabled, but has been inhibited with the activation of an external discrete.
Self-Test Level 1	<i>“Approach Monitor INOP”</i>	Stabilized Approach Monitor enabled but the function is inoperative
Self-Test Level 1	<i>“Runway Awareness OK”</i> Note: For MKV-A EGPWS, or MKV/MKVII -236-236, -057, -006 software versions and later.	Optional via RCD: Stabilized Approach Monitor enabled, functioning, has good position information, and required signals valid.
Self-Test Level 1	<i>“Runway Awareness INOP”</i> Note: For MKV-A EGPWS, or MKV/MKVII -236-236, -057, -006 software versions and later.	Optional via RCD: Stabilized Approach Monitor enabled but the function is inoperative. If option is selected <i>“Runway Awareness INOP”</i> status message is provide instead of <i>“Approach Monitor INOP”</i>

Product Description – SmartRunway®/SmartLanding®

MAINT. FUNCTION	MESSAGE	NOTES:
	Except where noted, all maintenance message voices are Male	All volume levels at same volume as existing EGPWS Self-Test messages
Self-Test Level 2	<i>“Approach Monitor Approach Speed Undefined”</i>	Not all aircraft provide a source of Reference or Approach speed which is required by the Stable Approach Monitor “Too Fast” function. This message will appear if the “Too Fast” feature is selected and there is no source of the required speed input.
Self-Test Level 3	<i>“RCD Part Number XXX-XXXX-XXX”</i> where X is the 10-digit installation-specific RCD part number.	Allows verification that the correct RCD is loaded into the EGPWS.

Appendix D: Altimeter Monitor Visuals, Aural and Volume Levels

Table D-1 provides a list Altimeter Monitor aural and visual alerts.

- (1) The Altimeter Monitor advisory is issued at one volume level. By default, the advisory is issued at the same volume level as the EGPWS Cautions and Warnings level, but the audio level may be adjusted to a different level using the RCD option.
- (2) Altimeter Monitor Self-Test messages are integrated into the existing EGPWS Self-Test functions and are issued at the same volume as existing EGPWS Self-Test messages (6dB lower than the EGPWS Cautions and Warnings defined by the Program Pin strapping).

Table D-2 provides a listing of Altimeter Monitor maintenance messages.

Table D-1: Corrected Altitude Monitor Messages and Volume Levels

REF SEC	MONITOR	AURAL MESSAGE Male or Female	VISUAL MESSAGE	NOTES:	VOLUME LEVEL (see above)
8.1 & 8.2	Altimeter Monitor	<i>“Altimeter Setting”</i>	ALTM SETTING (in amber)	Advisory	(1)

Table D-2: Corrected Altitude Monitor Maintenance Messages

MAINT. FUNCTION	MESSAGE	NOTES:
	Except where noted, all maintenance message voices are Male	All volume levels at same volume as existing EGPWS Self-Test messages
Self-Test Level 1	<i>“Approach Monitor Inhibited”</i> Note: For MKV-A, or MKV/MKVII -236-236, -057, -006 software versions and later	Altimeter Monitor enabled and inhibit option selected and activation of an external inhibit discrete.
Self-Test Level 1	<i>“Altimeter Monitor INOP”</i>	Altimeter Monitor enabled but the function is inoperative
Self-Test Level 1	<i>“Runway Awareness OK”</i>	Optional via RCD: Altimeter Monitor enabled,

Product Description – SmartRunway®/SmartLanding®

MAINT. FUNCTION	MESSAGE	NOTES:
	Except where noted, all maintenance message voices are Male	All volume levels at same volume as existing EGPWS Self-Test messages
Self-Test Level 1	<p>Note: For MKV-A, or MKV/MKVII -236-236, -057, -006 software versions and later</p> <p><i>“Runway Awareness INOP”</i></p> <p>Note: For MKV-A, or MKV/MKVII -236-236, -057, -006 software versions and later</p>	functioning, and required signals valid.
Self-Test Level 2	<i>“Altimeter Monitor GPS Signal Undefined”</i>	Optional via RCD: Approach Monitor enabled but the function is inoperative. If option is selected <i>“Runway Awareness INOP”</i> status message is provided instead of <i>“Altimeter Monitor INOP”</i>
Self-Test Level 2	<i>“Altimeter Monitor Static Air Temperature Undefined”</i>	The Altimeter Monitor requires a GPS input. This message will appear if the monitor is selected and there is no source of GPS.
Self-Test Level 3	<i>“RCD Part Number XXX-XXXX-XXX”</i> where X is the 10-digit installation-specific RCD part number.	Allows verification that the correct RCD is loaded into the EGPWS.

Appendix E: Takeoff Flap Configuration Monitor Visuals, Aural and Volume Levels

Table E-1 provides a list of Takeoff Flap Configuration Monitor aural and visual alerts.

- (1) The Takeoff Flap Configuration Monitor is issued at one volume level. By default, the advisory is issued at the same volume level as the EGPWS Cautions and Warnings level, but the audio level may be adjusted to a different level using the RCD option.
- (2) Takeoff Flap Configuration Monitor Self-Test messages are integrated into the existing EGPWS Self-Test functions and are issued at the same volume as existing EGPWS Self-Test messages (6dB lower than the EGPWS Cautions and Warnings defined by the Program Pin strapping). However, the volume level can be adjusted differently via the RCD.

Table E-2 provides a listing of Takeoff Flap Configuration Monitor maintenance messages.

Table E-1: Takeoff Flap Configuration Monitor Aural Messages

REF SEC	MONITOR	AURAL MESSAGE Male or Female	VISUAL MESSAGE	NOTES:	VOLUME LEVEL (see above)
9.1	Takeoff Flap Configuration Monitor	<i>"Flaps-Flaps"</i>	FLAPS (in amber)	Caution	(1)

Table E-2: Takeoff Flap Configuration Monitor Maintenance Messages

MAINT. FUNCTION	MESSAGE	NOTES:
	Except where noted, all maintenance message voices are Male	All volume levels at same volume as existing EGPWS Self-Test messages
Self-Test Level 1	<i>"Flaps Monitor Inhibited"</i>	Takeoff Flap Configuration Monitor enabled but the function is inhibited
Self-Test Level 1	<i>"Flaps Monitor INOP"</i>	Takeoff Flap Configuration Monitor enabled but the function is inoperative
Self-Test Level 1	<i>"Runway Awareness INOP"</i> Note: For MKV-A, or MKV/MKVII -236-236, -057, -006 software versions and later	Optional via RCD: Takeoff Flap Configuration Monitor enabled but the function is inoperative. If option is selected <i>"Runway Awareness INOP"</i> status message is provide instead of <i>"Flaps Monitor INOP"</i>
Self-Test Level 2	<i>"Flaps Monitor - Flap Angle Undefined"</i>	Not all aircraft provide a source of Flap Position which is required by the Takeoff Flap Configuration Monitor. This message will appear if the Takeoff Flap Configuration Monitor is selected and there is no source of the required input.
Self-Test Level 3	<i>"RCD Part Number XXX-XXXX-XXX"</i> where X is the 10-digit installation-specific RCD part number.	Allows verification that the correct RCD is loaded into the EGPWS.

Appendix F: Long Landing Monitor Visuals, Aurals and Volume Levels

Table F-1 provides a list Long Landing Monitor aural and visual alerts.

- (1) The Long Landing Monitor is issued at one volume level. By default, the alert is issued at the same volume level as the EGPWS Cautions and Warnings level. However, the volume level can be adjusted differently via the RCD.
- (2) Long Landing Monitor Self-Test messages are integrated into the existing EGPWS Self-Test functions and are issued at the same volume as existing EGPWS Self-Test messages (6dB lower than the EGPWS Cautions and Warnings defined by the Program Pin strapping).

Table F-2 provides a listing of Long Landing Monitor maintenance messages.

Table F-1: Long Landing Monitor Displayed Messages

REF SEC	MONITOR	AURAL MESSAGE Male or Female	VISUAL MESSAGE	NOTES:	VOLUME LEVEL (see above)
10	Long Landing Monitor	<i>“Long Landing-Long Landing”</i> Optional: <i>“Deep Landing-Deep Landing”</i>	LONG LANDING (in amber) Optional: DEEP LANDING (in amber) If configured overlaid on top of terrain image. Terrain display must be selected to see the visual indication.	Caution	(1)

Table F-2: Long Landing Monitor Maintenance Messages

SAME AS RAAS – SEE APPENDIX B-2.

Appendix G: Aircraft Compatibility Tables

Three of the functions described in this document require inputs that are not present in all aircraft configurations. These functions are the Stabilized Approach Monitor Excessive Approach Speed function described in section 5, the Takeoff Flap Configuration Monitor described in section 7, and the Altimeter Monitor described in section 6.

To use the Stabilized Approach Monitor's Excessive Speed function, the EGPWS must have a source of Approach or Reference Speed. For some aircraft, this is not an option, and so the monitor cannot be selected. For other aircraft types this data may either already be supplied to the EGPWS, or can be supplied, by adding wiring to an ARINC 429 source of the data. Note that the Excessive Speed Monitor is NOT available with installations that use the MKVII EGPWS.

To use the Takeoff Flap Configuration Monitor, the EGPWS must already be connected to a source of flap position. Generally speaking, this means most aircraft types that use the Reactive Windshear function of the EGPWS, which can also require flap position, can select the Takeoff Flap Configuration Monitor (but this is not always the case).

To use the Altimeter Monitor, the EGPWS must already be connected to a source of Static Air Temperature as defined in the appropriate ICD (MKV-A, MKV, or MKVII).

The following tables identify which aircraft types can, and cannot, select these three monitors. Table G-1 is for the MKV and MKV-A EGPWS, and Tables G-2 and G-3 are for the MKVII EGPWS.

For the MKV and MKV-A, the table has four columns listed after each aircraft type. An 'X', 'X2' or 'X3' in a column indicates the following:

1: An 'X', 'X2' or 'X3' in column 1 indicates the aircraft is compatible with the Excessive Speed Monitor with no wiring changes. That said, the operator must confirm that the FMS supplies the Approach/Reference speed as defined in the ICD for the aircraft type. (For example, some FMS may only output speed if a Speed Tape Display option is selected.) An 'X2' in column 1 indicates that MKV-A EGPWC or MKV EGPWC p/n 965-0976-0XX-232-232 or later, or 965-1690-055 or later, or 965-1676-005 or later is required. An 'X3' in column 1 indicates that MKV-A EGPWC or MKV EGPWC p/n 965-0976-0XX-234-234 or later is required.

2: An 'X' or 'X2' in column 2 indicates the aircraft is compatible with the Excessive Speed Monitor with a wiring change if the FMS supplies the Approach Speeds and Speed Control Mode labels as defined in the ICD for the aircraft type. An 'X2' in column 2 indicates that MKV-A EGPWC or MKV EGPWC p/n 965-0976-0XX-232-232 or later, or 965-1676-005 or later, or 965-1690-055 or later is required.

3: An 'X', 'X2' or 'X3' in column 3 indicates the aircraft is compatible with Takeoff Flap Configuration Monitor. However, an 'X2' in column 3 indicates that the EGPWS must be program pinned to enable the Reactive Windshear Function for the Takeoff Flap Configuration Monitor to work. An X3 in the column indicates that MKV-A EGPWC or MKV EGPWC p/n 965-0976-0XX-234-234 or later is required.

Regarding the compatibility of the Takeoff Flap Configuration Monitor: Potential users must be aware of the critical importance of the 'X2' note in column 3. They must confirm the EGPWS is both connected to a source of flap angle as defined in the EGPWS ICD, and that:

- If the Flap Angle signal type is defined in the ICD as 'Windshear' and the Reactive Windshear function of the EGPWS is enabled, then the monitor can be selected.
- If the Flap Angle signal type is defined in the ICD as 'Basic', then the monitor can be selected regardless of whether the Reactive Windshear function is enabled or not.

4: An 'X' in column 4 indicates the aircraft is compatible with the Altimeter Monitor.

IMPORTANT NOTE: If a full-up ARINC743/743A GPS connection to the EGPWS is not present, then NONE of the features described in this document are available.

Table G-1: MKV Aircraft Type Compatibility Table

AIRCRAFT TYPE	AIRCRAFT TYPE NUMBER*	1	2	3	4
Airbus A300-600 (AA)	108	-	-	-	-
Airbus A300-600R/A310 (Production Aircraft)	172	-	-	-	X
Airbus A300-600R/A310 (Mercury GPS Compatible)	230	-	-	-	X
Airbus A318/A319/A320/A321 Alternate Lamp Format	132	-	X	-	X
Airbus A319/A320/A321 (UA)	1	-	X	-	X
Airbus A318/A319/A320/A321	113	-	X	-	X
Airbus A319/A320/A321 Contained Popup/ Alternate Lamp Format (BA)	148	-	-	-	X
Airbus A318/A319/A320/A321 (Mercury GPS Compatible)	229	-	-	-	X
Airbus A330/340 (DLH/Cathay)	133	-	X2	-	X
Airbus A330/340 OEM	57	-	X2	-	X
Airbus A330/A340 Alternate Lamp Format	136	-	X2	-	X
Airbus A330/A340 (Mercury GPS Compatible)	228	-	-	-	X
Avro RJ/BAe 146 with Bendix PPI Display	55	-	-	-	X
Avro RJ/BAe 146 with PPI Display & WXR Scan Control	54	-	-	-	X
Boeing 707	213	X2	-	X	X
Boeing 737-200 Delta Airlines	187	-	-	-	-
Boeing 737-300 Basic	4	X2	-	X2	X
Boeing 737-300 Contained Popup/Alternate Lamp Format (BA)	144	X2	-	X2	X
Boeing 737-300 OEM	192	X2	-	X2	X
Boeing 737-300 UAL	217	X2	-	X2	X
Boeing 737-300 UAL/Alternate Lamp Format	218	X2	-	X2	X
Boeing 737-300 with PPI Display	16	X2	-	X2	X
Boeing 737-300 with Large Area Display	10	X2	-	X2	X
Boeing 737-300 No WXR ON Label (DAL)	174	X2	-	X2	X
Boeing 737-300 OEM with Digital Glideslope	214	X2	-	X2	X
Boeing 737-400 (AK)	101	X2	-	X2	X
Boeing 737-400 Basic	8	X2	-	X2	X
Boeing 737-400 Contained Popup/Alternate Lamp Format (BA)	145	X2	-	X2	X
Boeing 737-400 OEM	193	X2	-	X2	X
Boeing 737-400 UAL	225	X2	-	X2	X
Boeing 737-400 UAL/Alternate Lamp Format	226	X2	-	X2	X
Boeing 737-400 with PPI Display	18	X2	-	X2	X
Boeing 737-400 No WXR ON Label (Lufthansa)	227	X2	-	X2	X
Boeing 737-400 OEM with Digital Glideslope	215	X2	-	X2	X
Boeing 737-500 Basic	9	X2	-	X2	X
Boeing 737-500 Contained Popup/Alternate Lamp Format (BA)	143	X2	-	X2	X
Boeing 737-500 Lufthansa	175	X2	-	X2	X
Boeing 737-500 OEM	194	X2	-	X2	X
Boeing 737-500 UAL	219	X2	-	X2	X
Boeing 737-500 UAL/Alternate Lamp Format	220	X2	-	X2	X
Boeing 737-500 with PPI Display	17	X2	-	X2	X
Boeing 737-500 OEM with Digital Glideslope	216	X2	-	X2	X
Boeing 737-600 Integrated	195	X2	-	X	X
Boeing 737-700 Integrated	196	X2	-	X	X
Boeing 737-NG Integrated with Windshear Update	212	X	-	X	X
Boeing 737-700 IGW Integrated (BBJ)	207	X2	-	X	X
Boeing 737-800 Integrated	197	X2	-	X	X
Boeing 747-400 BA	2	X2	-	X2	X

Product Description – SmartRunway®/SmartLanding®

AIRCRAFT TYPE	AIRCRAFT TYPE NUMBER*	1	2	3	4
Boeing 747-400 JAL Simulator	111	X2	-	X2	X
Boeing 747-400 Basic	30	X2	-	X2	X
Boeing 747-400 Integrated	198	X2	-	X2	X
Boeing 747-400 LCF Integrated	190	X2	-	X2	X
Boeing 747-400 Simulator	100	X2	-	X2	X
Boeing 747-400 with Display Update	188	X2	-	X2	X
Boeing 747-8 Freighter/Passenger	189	X2	-	X2	X
Boeing 747-8 Passenger (future use if needed)	191	X2	-	X2	X
Boeing 757-200 (AA)	105	X2	-	X2	X
Boeing 757-200 Basic	6	X2	-	X2	X
Boeing 757-200 Contained Popup (BA)	146	X2	-	X2	X
Boeing 757-200 Integrated	199	X2	-	X2	X
Boeing 757-200 (Saudi Royal)	116	X2	-	X2	X
Boeing 757-200 UAL	224	X2	-	X2	X
Boeing 757-200 No WXR ON Label (DAL)	169	X2	-	X2	X
Boeing 757-300 Integrated	200	X2	-	X2	X
Boeing 767-200 (AA)	106	X2	-	X2	X
Boeing 767-200 Basic	31	X2	-	X2	X
Boeing 767-200 Integrated	201	X2	-	X2	X
Boeing 767-200 Integrated with LFDS	209	X2	-	X2	X
Boeing 767-200 UAL	221	X2	-	X2	X
Boeing 767-200 No WXR ON Label (DAL)	170	X2	-	X2	X
Boeing 767-300 Basic	5	X2	-	X2	X
Boeing 767-300 Integrated	202	X2	-	X2	X
Boeing 767-300 Integrated with LFDS	210	X2	-	X2	X
Boeing 767-300 UAL	223	X2	-	X2	X
Boeing 767-300 No WXR ON Label (DAL)	171	X2	-	X2	X
Boeing 767-300ER (AA)	109	X2	-	X2	X
Boeing 767-300ER Basic	3	X2	-	X2	X
Boeing 767-300ER Contained Popup (BA)	147	X2	-	X2	X
Boeing 767-300ER Integrated	203	X2	-	X2	X
Boeing 767-300ER Integrated with LFDS	211	X2	-	X2	X
Boeing 767-300ER UAL	222	X2	-	X2	X
Boeing 767-300ER No WXR ON Label (DAL)	173	X2	-	X2	X
Boeing 767-400 Integrated	204	X2	-	X2	X
Boeing 777-200 Integrated *requires -232-232 Mod 1	205	X2*	-	X	X
Boeing 777-200LR/300ER Integrated *requires -232-232 Mod 1	208	X2*	-	X	X
Boeing 777-300 Integrated *requires -232-232 Mod 1	206	X2*	-	X	X
Bombardier Challenger 300	34	-	-	X3	X
Bombardier CL-601/3A (Rosemont AOA), Audio On	85	X3	-	X	X
Bombardier CL-601/3A (Rosemont AOA), TCAS Inhibit	165	X3	-	X	X
Bombardier CL-601/3A (SafeFlight AOA), Audio On	81	X3	-	X	X
Bombardier CL-601/3A (SafeFlight AOA), TCAS Inhibit	161	X3	-	X	X
Bombardier CL-604	39	-	-	-	X
Bombardier CL-604 Integrated	40	-	-	-	X
Bombardier CL-605 Integrated	56	-	-	-	X
Bombardier CRJ-100/200 Non-Integrated	43	-	-	X3	X
Bombardier CRJ-100/200 Integrated * wiring change required for Flap Angle input.	47	-	-	X3*	X
Bombardier CRJ-700/900 Family	46	-	-	X3	X

Product Description – SmartRunway®/SmartLanding®

AIRCRAFT TYPE	AIRCRAFT TYPE NUMBER*	1	2	3	4
Bombardier Global Express/Global 5000	97	X3	-	X	X
Bombardier Learjet Model 45 (No Display)	102	X3	-	X	X
Bombardier Learjet Model 40/45 Family (Integrated Display)	166	X3	-	X	X
Bombardier Learjet Model 60/60XR	78	X3	-	X	X
CASA (partial GPS)	155	-	-	-	-
Cessna Citation Jet 1 (CJ1)	37	-	-	-	X
Cessna Citation Jet 2 (CJ2)	38	-	-	-	X
Cessna Citation Jet 3 (CJ3)	32	-	-	-	X
Cessna Citation Jet 4 (CJ4)	168	-	-	X	X
Cessna Citation X	62	X3	-	X	X
Cessna Encore Plus with ProLine 21	160	-	-	X	X
Cessna Excel	103	-	-	-	X
Cessna Excel (Low speed ILS)	167	-	-	-	X
Cessna XLS Plus with ProLine 21	159	-	-	X	X
Dassault Falcon 20F/AHRS, ProLine 2	70	X3	-	X	X
Dassault Falcon 20F/IRS, ProLine 2	71	X3	-	X	X
Dassault Falcon 20F, Integrated ProLine 4	77	-	-	X	X
Dassault Falcon 2000/2000EX	91	-	-	X	X
Dassault Falcon 2000 Non-integrated	125	-	-	X	X
Dassault Falcon 50	82	X3	-	X	X
Dassault Falcon 50, Integrated ProLine 4	94	-	-	X	X
Dassault Falcon 50EX	92	-	-	X	X
Dassault Falcon 50EX Non-Integrated	126	X3	-	X	X
Dassault Falcon 900/900B	75	X3	-	X	X
Dassault Falcon 900C/900EX	93	X3	-	-	X
Dassault Falcon 900C/900EX (No Display)	157	X3	-	-	X
DeHavilland Dash 8-400	88	-	-	X	X
DeHavilland Dash 8-400 with Universal FMS/GPS	152	X3	-	X	X
Dornier 328 Jet	35	X3	-	X2	X
Dornier 328 Turboprop	41	X3	-	-	X
Douglas DC 8-72	130	-	-	-	X
Douglas DC-9-82/-83 EFIS	139	-	-	-	X
Douglas MD10	44	-	-	-	X
Douglas MD11	45	-	-	-	X
Douglas MD80 (AA/EFIS)	114	-	-	-	X
Douglas MD80 (AA/non-EFIS)	115	-	-	-	X
Douglas MD80 (Alaska/EFIS)	180	-	-	-	X
Douglas MD80 (Alaska/Non-EFIS)	179	-	-	-	X
Douglas MD80 with Digital ILS	119	-	-	-	X
Douglas MD87 with PPI Display	120	-	-	-	X
Douglas MD88/90 EFIS Delta Airlines	118	-	-	-	X
Douglas MD95	129	-	-	-	X
Embraer-135/145 and Legacy 600	33	X2	-	X2	X
FAA – FIAS Beechcraft 300	74	-	-	-	X
FAA - FIAS Beechcraft 300 with ProLine 21	60	-	-	-	X
FAA - FIAS CL601/3R & Learjet 60	76	-	-	-	X
FAA - FIAS CL601/3R (with reactive windshear)	142	-	-	-	X
FAA - FIAS Learjet 60 (with reactive windshear)	80	-	-	-	X
Fokker 100 (AA/IRS)	131	-	-	-	-
Gulfstream G-100 (IAI Astra SPX) Non-Integrated	90	X3	-	-	X
Gulfstream G-100 (IAI Astra SPX) Integrated	156	-	-	-	X
Gulfstream G-150	177	-	-	X	X
Gulfstream G-200 (IAI Galaxy) Non-Integrated	89	X3	-	X	X

Product Description – SmartRunway®/SmartLanding®

AIRCRAFT TYPE	AIRCRAFT TYPE NUMBER*	1	2	3	4
Gulfstream G-200 (IAI Galaxy) Integrated	154	-	-	X	X
Gulfstream II	68	X3	-	X	X
Gulfstream IIB/III	69	X3	-	X	X
Gulfstream IV	79	X3	-	X	X
Gulfstream IV Dual IRS/ADC/RA	87	X3	-	X	X
Gulfstream V (with 2 ILS buses)	96	X3	-	X	X
Gulfstream V (with 4 ILS buses)	104	X3	-	X	X
Hawker/Beechcraft (HBC) BeechJet 400A	162	-	-	X	X
HBC BeechJet 400A Integrated	163	-	-	X	X
HBC Hawker 800 (Collins ProLine II cockpit)	65	-	-	X	X
HBC Hawker 800 (Honeywell cockpit)	66	X3	-	X	X
HBC Hawker 800 (Collins ProLine II cockpit/SafeFlight AOA)	73	-	-	X	X
HBC Hawker 800 (Honeywell cockpit/SafeFlight AOA)	138	X3	-	X	X
HBC Hawker 750/850XP/900XP) ProLine 21	176	-	-	X	X
HBC Hawker 1000	67	X3	-	X	X
HBC Hawker 4000 (Horizon)	110	-	-	X	X
HBC Premier 1/1A	112	-	-	X	X
Honeywell King Air C-90 (Commercial, Non Mercury GPS)	64	-	-	-	X
Honeywell King Air C-90 (Mercury GPS)	98	-	X	X*	X
*Special Flap configuration					
Honeywell Sabre 65	117	-	-	-	X
Lockheed C-130 PSCI	123	-	-	-	-
Lockheed C-5 (limited GPS interface)	137	-	-	-	-
NIMROD MRA4 (No GPS)	122	-	-	-	-
SAAB 2000	36	-	-	X2	X
Tupolev / Ilyushin TU-204/IL-96-300	158	-	-	-	-
KC-135 (No GPS)	135	-	-	-	-
RC-135 (No GPS)	134	-	-	-	-
VC-135 Speckled Trout (no GPS)	153	-	-	-	-
TEST	63	-	-	-	-
TEST 2	95	-	-	-	-

* For MKV-A installations where a loadable configuration file (APD or OSS) is used in place of hardware program pins, the type number for a given aircraft type will be the same as those listed above, plus 500. Refer to the Interface Control Document for the MKV-A EGPWS.

MKVII NOTES

If a full-up ARINC743/743A GPS connection to the EGPWS is not present, then NONE of the features described in this document are available.

No MKVII installations support the Excessive Speed Monitor.

Table G-2 lists the MKVII Aircraft types that are compatible with the Takeoff Flap Configuration Monitor

Table G-3 lists the MKVII Air Data Types that are compatible with the Altimeter Monitor.

Table G-2: MKVII Aircraft Type Takeoff Flap Configuration Monitor Compatibility Table

AIRCRAFT ID	MKVII Aircraft Type	Takeoff Flap Monitor Compatible
0	Qual Test Config	YES
1	Test Type 1	YES
2	Test Type 2	YES
3	No Windshear (Turbo Prop)	NO
4	No Windshear (Biz-Jet)	NO
5	No Windshear (Commercial AT)	NO
6	B727-200	YES
7	No Windshear (Biz-Jet Bank Angle, Normal Mode 4)	NO
8	Hawker 800 (SafeFlight AOA)	YES
9	Hawker 800 (Teledyne AOA)	YES
10	Hawker 700 (Teledyne AOA)	YES
11	DC-10-10/15	YES
13	DC-9-30, 32 and C-9A,C	YES
14	DC-10-30/40	YES
16	B747-100/200/300	YES
19	727-200 Simulator	YES
20	727-100	YES
23	DC-10-10 Simulator	YES
27	DC-10-30/40 Simulator	YES
28	Citation V/Ultra (Teledyne AOA)	YES
29	Citation V/Ultra (SafeFlight AOA)	YES
30	Citation III/VI/VII (Teledyne AOA)	YES
31	Citation Bravo (SafeFlight AOA)	YES
32	Lear 55, 55B, 55C (Conrac/Gulton AOA)	YES
33	Lear 35 (Conrac/Gulton 60 deg AOA)	YES
34	Falcon 20F (Teledyne AOA)	YES
35	Falcon 20F (Conrac/Gulton AOA)	YES
36	Falcon 50 (Teledyne AOA)	YES
37	Lear 31A	YES
38	Gulfstream G-II (Teledyne AOA)	YES (Full Flaps Only)
39	Gulfstream G-IIB/G-III (Teledyne AOA)	YES (Full Flaps Only)
40	Boeing 737-200 ADV	YES
41	Boeing 727-100 with PLI	YES
42	Boeing 747-100/200 with PLI	YES
43	DC -8-71/73 with PLI	YES
44	Canadair CL600 (1A11)	YES
45	Canadair CL601 (2A12)	YES
46	BeechJet 400	YES

Product Description – SmartRunway®/SmartLanding®

AIRCRAFT ID	MKVII Aircraft Type	Takeoff Flap Monitor Compatible
47	Lear 35 (Conrac/Gulton 50 deg AOA	YES
48	C-141 (use with Cat 14, ID 8)	YES
49	C-130 (use with Cat 14, ID 8)	YES
50	ASTRA SP (IAI 1125)	YES
51	Westwind II (IAI 1124A)	YES
52	Boeing 747-100/200 Simulator w/PLI	YES
53	DC-8-71/73 Simulator w/PLI	YES
54	Boeing 727-100 Simulator w/PLI	YES
55	Falcon 10/100	YES
56	Honeywell King Air Test aircraft (C130 military modes, use with Cat 14, ID 8).	NO
57	L1011-385	YES
58	Airbus A300-B2/B4	YES
59	Boeing 747 SP	YES
60	DC 9-10	YES
61	DC 9-21	YES
62	DC 8 ALL	YES
63	Honeywell King Air with Pitch Alert (Test Only)	NO
64	VP/UP-3 (use with Cat 14, ID 8)	NO
65	C-2A (use with Cat 14, ID 8)	NO
66	Citation Encore (SafeFlight AOA)	YES
67	Falcon 200 (Teledyne AOA)	YES
68	Citation-II/550 (Teledyne AOA)	YES
69	Jetstar II (Teledyne AOA)	YES

Product Description – SmartRunway®/SmartLanding®

TABLE G-3: MKVII ADC TYPE ALTITUDE MONITOR COMPATIBILITY TABLE

Air Data Type	Description	Altimeter Monitor Compatible
0	Single Analog/Digital Baro Corr Alt. (Test only Air Data interface)	YES
1	Single Digital 429/Coarse & Fine Sync Baro Corr Alt.	YES
2	Single Digital 575/Digital 575 Baro Corr Alt.	YES
3	Single Digital 429 with Baro Corr Alt (No WS)	NO
4	Single DC Analog /DC Baro Corr Alt. (Simulators)	YES
5	Single Digital 429 with Baro Corr Alt	YES
6	Single Digital 575 with Baro Corr Alt & No TAS	YES
7	Single Analog AZ-241-No Baro Corr Alt	NO
8	Single Analog CIC 02942/Dual Sync Baro Corr Alt	YES
9	Single Analog AZ-242/Dual Sync Baro Corr Alt	YES
10	Single Analog AZ-241/Dual Sync Baro Corr Alt(No SAT)	NO
11	Single Digital 429 (DAU) with Baro Corr Alt (TAT)	NO
12	Dual Digital 429 (DAU) with Baro Corr Alt (TAT)	NO
13	Single ARINC 565 with Baro Corr /ARINC 545 CAS/no SAT	NO
14	Dual Analog, Digital Baro Corr. Alt and SAT for C-141	YES
15	Dual Digital 429 DADC (AZ-810), Digital Baro. Corr. Alt. from FMS, Digital Inertial Vert. Speed and Inertial Altitude from IRS	YES
16	Single ARINC 565 with Baro Corr Alt	YES
17	Single ARINC 565 with SAT/No Corrected Baro Altitude	NO
18	Single ARINC 565 with SAT & validity /non-ARINC Corr Baro Alt (L1011)	YES
21	ARINC 575 Mach/Alt Rate with Sync Baro Corr Alt without valid	NO
22	Dual Digital 429/Analog SAT	YES
23	Single Digital 429/Second channel with Baro Corr Alt.	YES
24	Single ARINC 565 no Baro Corr / ARINC 545 CAS/ no SAT	NO
25	Single Digital 429 no Baro Corr Alt.	NO
26	Dual A429 with Baro Corr Alt.	YES
27	Single ARINC 429 with no Baro Corr Alt or TAS	NO
28	Dual Digital 429/Analog TAT	NO
29	Single Analog AZ-241 using its Coarse/Fine Corrected Baro Altitude outputs	NO
30	Analog ADC SAT, Concorde's Crouzet and Jaeger Altimeters	YES
31	Digital ARINC 429 via dual Collins IOC buses	YES

Appendix H: Boeing OEM RAAS installation

This appendix describes how the Boeing Service Bulletin for RAAS, and the Boeing factory installation, differs from a typical STC installation.

The differences can be summarized as follows:

For MKV, An EGPWS program pin is used to enable RAAS along with the RCD.

For MKV-A, the functions described in this document are enabled via the OSS file instead of the RCD.

A RAAS inhibit switch is provided.

Annunciation of the status of RAAS is always provided (via cockpit lamp or EICAS messages).

Visuals, either via raster overlay, or stroke written characters on the NDs, are activated for RAAS cautions.

RAAS Status items: The following conditions can activate flight deck status annunciations:

- 1: RAAS INOP (inoperative) due to input failures.
- 2: Aircraft is not program pinned to activate RAAS.
- 3: Aircraft is program pinned to activate RAAS but there is a problem with the RCD/OSS, no RCD/OSS is present, or the selected aircraft type is not in the RCD/OSS.
- 4: Aircraft is approaching, or is at, an airport that is not RAAS qualified.
- 5: EGPWS power is off.
- 6: RAAS is manually inhibited.
- 7: RAAS Inhibit switch unreasonable: Similar to how the Flap & Gear Inhibit switches are monitored, if the RAAS Inhibit input is selected either intentionally, or via a switch/wiring fault, then once airspeed exceeds 250 knots for 60 seconds the RUNWAY INOP annunciation will come on for non-EICAS aircraft. For EICAS aircraft separate annunciations are provided for the state of the inhibit switch and the state of the inhibit switch monitor fault.
- 8: RAAS not functional due to insufficient GPS accuracy.

As the various Boeing models have different display and maintenance message capabilities, the following describes how the status items are displayed for each model:

737NG	
Inhibit Switch	A modified Ground Proximity switch panel is provided that adds a “RUNWAY INHIBIT” switch next to the Terrain, Gear, and Flap Inhibit switches. Like the other switches on this module, it is a guarded switch with no illumination when selected.
Status	An amber “RUNWAY INOP” light is added to the modified Ground Proximity switch panel. This light is turned on for all of the RAAS status items listed above except #6.
Visuals	Amber SHORT RUNWAY and ON TAXIWAY raster text on ND Note: Provisions are present such that if the 737NG display is updated to provide stroke written visuals for these messages the raster text will be automatically suppressed.

747-400 - Preliminary	
Inhibit Switch	A modified Ground Proximity switch panel is provided that adds a “RUNWAY OVRD” switch along with the Terrain, Gear, and Flap Inhibit switches. White “OVRD” is displayed on the switch when inhibit is selected.
Status	The override switch has an amber “INOP” annunciator built into it to display RAAS Status. This annunciator is turned on for all the RAAS status items listed above except #6.
Visuals	Amber SHORT RUNWAY and ON TAXIWAY raster text on ND

757/767 - Preliminary	
Inhibit Switch	A RUNWAY OVRD switch is will be added. White “OVRD” is displayed on the switch when inhibit is selected.
Status	The override switch has an amber “INOP” annunciator built into it to display RAAS Status. This annunciator is turned on for any of the RAAS status items listed above except #6.
Visuals	Amber SHORT RUNWAY and ON TAXIWAY raster text on ND

Product Description – SmartRunway®/SmartLanding®

747-8	
Inhibit Switch	A modified Ground Proximity switch panel is provided that has a “RUNWAY OVRD” switch along with the Terrain, Gear, and Flap Inhibit switches. There is no ‘INOP’ annunciator in the switch. White “OVRD” is displayed on the switch when inhibit is selected.
Status	RAAS status is provided via the following EICAS messages: Amber RUNWAY SYS: Set for RAAS Status items 1, 3, 4 Amber RUNWAY POS: Set when GPS accuracy insufficient for RAAS Amber RUNWAY OVRD: Set when Runway Override switch selected Amber RUNWAY OVERRIDE SWITCH IS FAILED: CMC message for RAAS Status item 7
Visuals	Amber SHORT RUNWAY and ON TAXIWAY ND messages

777	
Inhibit Switch	A RUNWAY OVRD switch is added to the P5 overhead panel. There is no ‘INOP’ annunciator in the switch. White “OVRD” is displayed on the switch when inhibit is selected.
Status	Depending on the AIMS version, RAAS status can be provided via the following EICAS messages: Amber RUNWAY SYS: Set for RAAS Status items 1, 3, 4 Amber RUNWAY POS: Set when GPS accuracy insufficient for RAAS (AIMS 1 only) Amber RUNWAY OVRD: Set when Runway Override switch selected Amber RUNWAY OVERRIDE SWITCH IS FAILED: CMC message for RAAS Status item 7
Visuals	Amber SHORT RUNWAY and ON TAXIWAY raster text on ND for AIMS Blockpoint BPV14 and earlier. Note: If the displays provide stroke written visuals for these messages the raster text is automatically suppressed.

737-300/400/500 - Preliminary	
Inhibit Switch	Like the 737NG, a modified Ground Proximity switch panel may be provided that has a “RUNWAY INHIBIT” switch next to the Terrain, Gear, and Flap Inhibit switches. There is some variety among the various 737 switch configurations, so one inhibit switch installation will not fit all.
Status	Depending on the configuration an amber “RUNWAY INOP” light may be added to the modified Ground Proximity switch panel, or placed adjacent to a separate RUNWAY INHIBIT switch that will turn on for all RAAS status items listed above except #6.
Visuals	Amber SHORT RUNWAY and ON TAXIWAY raster text on ND

717/MD10/MD11 - Preliminary	
Inhibit Switch	A RUNWAY OVRD switch is added. White “OVRD” is displayed on the switch when inhibit is selected.
Status	The RWY OVRD switch has an amber “INOP” annunciator built into it to display RAAS Status. This annunciator is turned on for all of the RAAS status items listed above. In addition, the following EAD (Engine and Alert Display) messages may be added in the future. Amber RUNWAY FAIL: Set for RAAS Status items 1, 3. Amber RUNWAY NOT AVAIL: Set for RAAS Status items 4 and 8. Cyan RUNWAY OVRD: Set when RWY override switch selected.
Visuals	Amber SHORT RUNWAY and ON TAXIWAY raster text on ND Note: ARINC 429 outputs are set during these conditions for use if displays are updated to provide RAAS Caution messages. If that happens, an RCD change would be required to disable the raster messages.

MD8x - Preliminary	
Inhibit Switch	A RUNWAY OVRD switch is added. White “OVRD” is displayed on the switch when inhibit is selected.
Status	The RWY OVRD switch has an amber “INOP” annunciator built into it to display RAAS Status. This annunciator is turned on for all of the RAAS status items listed above except #5 & #6.
Visuals	Amber SHORT RUNWAY and ON TAXIWAY raster text on ND